



PSM10K

Operating Manual



A Message to Our Customers

*Thank you for purchasing the **PSM10K**. The **PSMailers** product line is the result of over 30 years of experience in the document processing industry. Through interfacing with customers like yourself and from hands-on experience in the field, our Research and Development Team has focused on a solution providing both the dependability you expect from today's technology, while returning operational efficiency to your organization.*



The result of our experience and research is a powerful tool to improve your bottom line. We hope you enjoy this machine.

User comments and suggestions are always welcomed by our development team.

Table of Contents

- Operator Safety** 5
- Specifications** 6
- Unpacking & Setup** 7-8
 - Unpacking 7
 - Setup 8
- Machine Overview** 9-11
 - Machine Diagram 9
 - Capabilities 9
 - Controls 10
 - Fold Plates 11
 - Identifying Your Fold 11
- Feed Table Setup** 12-15
 - Setting the Paper Guide Width 12
 - Setting the Feed Gauge 13
 - Setting the Exit Guide Wheels 14
 - Setting the Fold Plates 15
- Machine Operation** 16-18
 - Loading the Feed Table 16
 - Operating the PSM10K 17
 - Operating in Batch Mode (*Optional Counter*) 17
 - Setting the Batch Total 17
 - Running in Batch Mode 17
 - Resetting the Batch Count 18
 - Operating in Manual Mode 18
 - Resetting the Count..... 18
- Maintenance** 19
- Troubleshooting** 20-23
 - Automatically Clearing a Paper Jam 20
 - Manually Clearing a Paper Jam 20
 - Diagnosing the Paper Jam 21
 - Misaligned Folds 21
 - Paper Feed Problems 22
 - Double Feeds 22
 - Won't Feed 23
 - Machine Won't Run 23

Operator Safety

- **Please review and follow all the safety precautions to ensure safe equipment operation.** The user is responsible for safe operating conditions. Read all operating instructions prior to operating machine.
-  **Warning:** Do not attempt to handle the equipment alone. It requires two people to handle and lift the equipment out of the packaging.
-  **Warning:** This unit contains moving parts. Watch for *Caution*, *Warning*, and *Electrical* stickers detailing proper operating conditions and user safety.
- *Never remove guards or product safety switches.* Removal of guards or switches will cause the unit to run improperly and can result in personal injury.
- *Keep all hands, fingers and objects away from moving parts.* Never attempt to reach into the machine while the power is on. Turn off the machine and disconnect the power cord before cleaning or servicing the machine, and before removing either fold plate. Injury may occur if proper operating procedure is not followed.
- *Plug the power cord into 115 VAC, 60 Hz outlet only.* Voltage up to 120 V will not damage the machine.
- The power cord and plug must be accessible at all times for disconnection.
- This unit is equipped with a 3-wire, grounded electrical cord. If the cord becomes damaged and needs to be replaced, it must be replaced with an authorized part available through the manufacturer or an authorized service agent.
- All machine maintenance should be performed only by factory authorized service personnel using factory authorized replacement parts. Contact your sales rep for more information.
- Keep the **PSM10K** away from extreme heat and moisture.
- Never operate the **PSM10K** while tired, drowsy, or under the influence of medication, drugs, or alcohol. Failure to do so can result in personal injury.
- Never operate the **PSM10K** with loose clothing or jewelry. Contain all long hair and neck ties prior to operating machine. Failure to do so could result in clothing, jewelry, or hair becoming entangled in moving parts.

Specifications

The **PSM10K** is designed to fold and seal up to 10,000 documents per hour, ensuring a good seal and a clean fold on every form, every time, whether the paper is perforated or plain.

The adjustable fold plates allow the machine to meet your changing document processing requirements. Below are the detailed machine specifications.

PSM10K Specifications

Variable Speed	Yes, 10,000/hour
Duty Cycle	125,000 sheets/month
Fold Types	C, V, Z, EZ, EC return envelope & custom folds
Fold Patterns	11" Half (V) 14" Half (V)
	11" Letter (C) 14" (Z)
	11" (Z) 14" Return Envelope (EC)
	14" Eccentric Z (EZ)
Paper Sizes	Up to 14" long, up to 8.5" wide
Counter	Manual/Batch
Conveyor	36" hinged conveyor included
Feed System	Bottom feed system
Drive System	AC fixed
Electrical	115 VAC, 60 Hz, 5A
Dimensions	12"H x 21.5"W x 41"D
Weight	75 Lbs.

Unpacking & Setup

Unpacking

When opening the **PSM10K** packaging, inspect it for any shipping damage. The shipper should be notified at once and the packing materials saved if there is any serious damage.

⚠ Warning: Do not attempt to remove the equipment from the packaging alone. Two people are required at all times to remove packaging and move the equipment.

Please make sure the following items are present in the packaging. If any items are missing please contact your sales rep before continuing.

1. This manual (1)
2. PSM10K (1)
3. AC Power Cord (1)
4. Upper & Lower Fold Plates (1 each)
5. Paper Guides (2)
6. Tool Kit
 - a. Breaker Bar
 - b. 7/16" Socket
 - c. 3/16" T-Handle Hex Driver



Figure 1: Upper Fold Plate



Figure 2: Lower Fold Plate



Figure 3: PSM10K

Unpacking & Setup

Setup

⚠ Warning: Do not attempt to remove the equipment from the packaging alone. Two people are required at all times to move the equipment.

Place the **PSM10K** on a sturdy table or cart. Check to verify that both fold plates are properly installed (see Figures 4 & 5). Both fold plates should rest snugly on the placement pins.

First insert the power cord into the **PSM10K** and then into a standard 115 VAC, 60 Hz outlet.

⚠ The power cord must be accessible for disconnect.

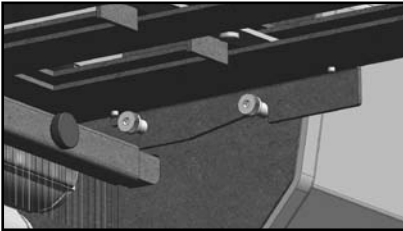

**Figure 4: Upper Fold Plate
in Proper Position**

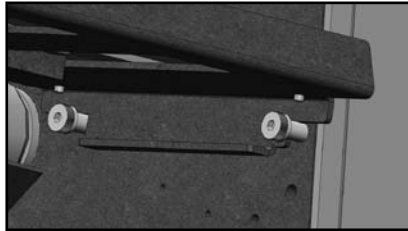

**Figure 5: Lower Fold Plate
in Proper Position**

Machine Overview

Machine Diagram

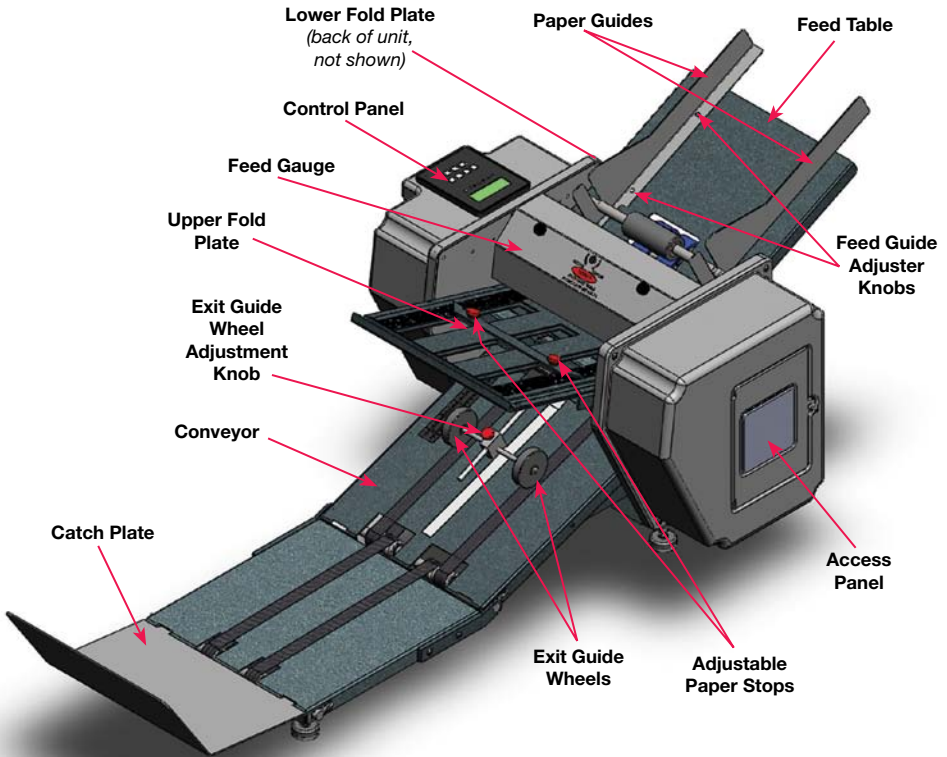

Figure 6: Machine Diagram

Capabilities

Your **PSM10K** is designed to be a versatile folding and sealing machine. Its capabilities include:

- Folding plain paper and forms from 20 lb. paper to 80 lb. stock.
- Folding all standard fold patterns (*see fold diagrams, page 11*).
- **Single fold capability:** when the bottom fold plate is in the half fold position, the upper fold plate can be set to lengths other than the standard *V-Fold* depending on your special needs.

Machine Overview

Controls

- !** Familiarize yourself with all machine controls prior to operating the machine.

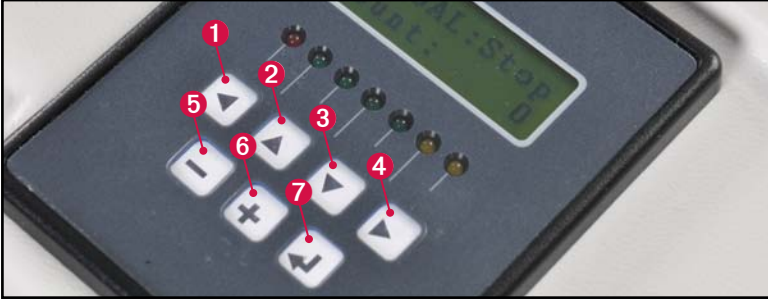

Figure 7: Control Panel

The **PSM10K Control Panel** has 7 buttons and a 2-line digital display to communicate with the user (Figure 7). When the machine is turned on, the display looks like Figure 8.

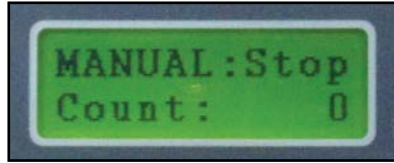

Figure 8: Default Mode

- 1** **Reverse** button is used to clear a jam (*lower fold plate must be removed*).
- 2** & **3** **Speed Up / Speed Down** buttons are used to set the Batch Count.
- 4** **Run** button is used to start the machine.
- 5** **Mode** button cycles through the operating modes.
- 6** **Clear** button is used to clear counts.
- 7** **Stop** button is used to stop the machine

Machine Overview

Fold Plates

The **PSM10K** is equipped with adjustable fold plates. The red thumbscrews can be loosened to allow you to move the paper stop to the correct position for your form, then tightened to hold the stop in place. All standard folds are marked on the scales of both the upper and lower fold plates. Set both fold plates to the desired setting (i.e. 11" Z-Fold) in order to perform that fold.

See *Setting the Fold Plates* (page 15) for more information.

Identifying Your Fold

1. Identify your paper size. 11" forms are the standard letter size; 14" forms are the standard legal size. Measure the form if necessary.
2. Identify the fold shape from the diagrams below.

Note: The *Eccentric Z (EZ)* and the *The Eccentric C (EC)* folds are a similar shape as the standard *Z-Fold* and *C-Fold*, but the lengths of the folds are not equal.

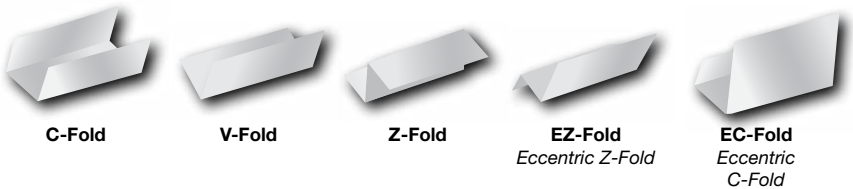

Feed Table Setup

Setting the Paper Guide Width

1. Loosen the *Feed Guide Adjuster Knobs* but don't fully remove them (*1-2 turns clockwise will loosen them*).
2. Place a 1/2" stack of the form to be run on the feed table.
3. Line the paper stack up against the stationery paper guide.
4. Push the moveable paper guide up against the paper stack so all the paper is aligned and the paper guide is snug against the side of the stack.
5. Hold the moveable paper guide in place with one hand and tighten the feed guide adjuster knobs with the other.

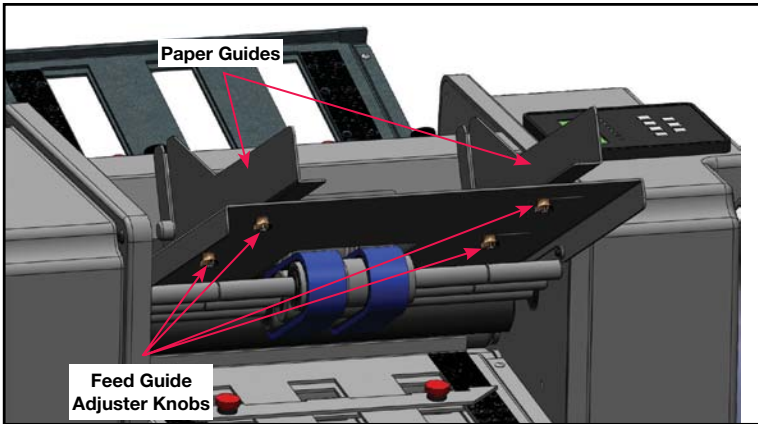

Figure 9: Feed Table Paper Guide Adjustment

Feed Table Setup

Setting the Feed Gauge

⚠ Make sure that the power switch is in the *off* position.

To properly set the Feed Gauge System, refer to Figure 10.

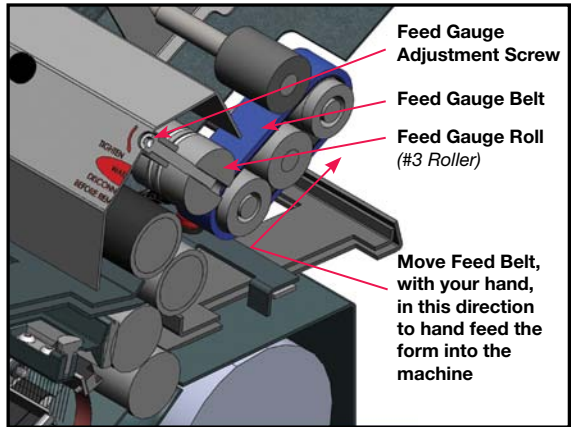

Figure 10: Feed Gauge Cross Section

1. Remove all paper from the feed table.
2. Insert the provided 3/16" T-Handle Hex Driver (inside tool kit) into Feed Gauge Adjustment Screw.
3. Turn the T-Handle 1/4 turn clockwise to loosen the Feed Gauge Wheel.
4. Place one form on the feed table and hand feed the form about 2" into the machine by moving the feed belt with your hand.
5. Turn the T-Handle 1/4 turn counter-clockwise.
6. Pull the paper out of the machine. You should feel resistance, but not too much. Repeat steps 4-6 until there is a moderate amount of resistance when pulling the form out. If it feels too tight, turn the T-Handle 1/4 turn clockwise.
7. Return the T-Handle to the tool kit.

Setting the Exit Guide Wheels

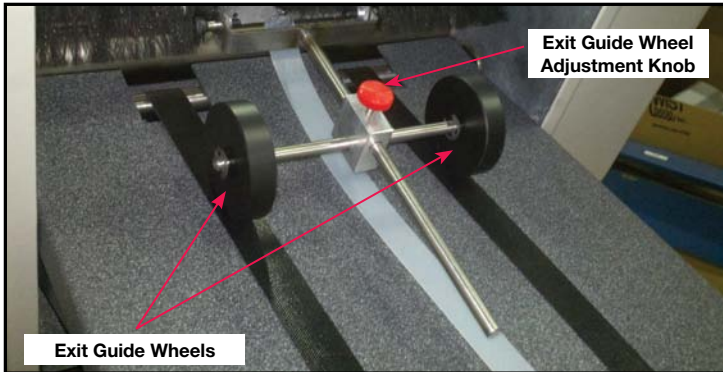

Figure 11: Exit Guide Wheels

The placement of the *Exit Guide Wheel* is important for the proper functioning of the conveyor (see *Figure 11*). To set the location:

1. Take a folded form and place it so one edge is just touching the steel roll.
2. Loosen the red *Exit Guide Wheel Adjustment Knob*.
3. Move the *Exit Guide Wheels* so they just touch the front edge of the form (see *Figure 12*).
4. Tighten the *Exit Guide Wheel Adjustment Knob*.

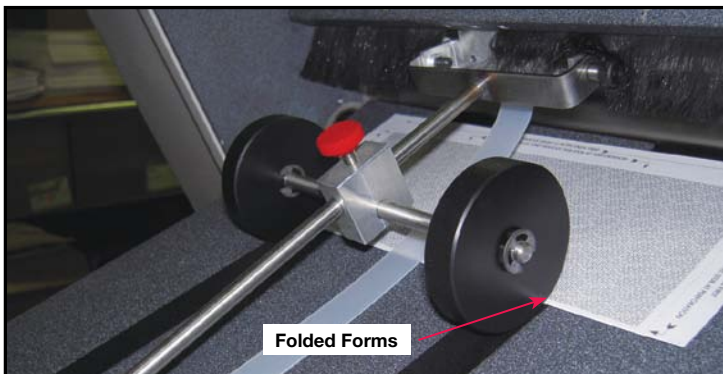

Figure 12: Exit Guide Wheel Adjustment

Setting the Fold Plates

1. Remove the fold plate from the machine.
2. Loosen the thumb-screws by turning counter-clockwise
3. Line up the tips on both sides of the paper stop with the appropriate line on the scale so that the appropriate white line on the scale is just visible (see Figure 13).

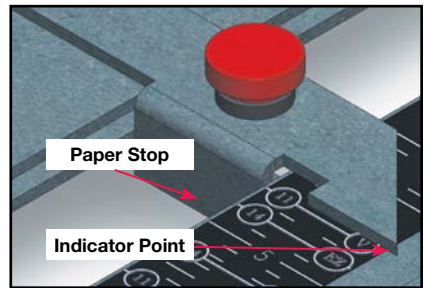

Figure 13: Paper Stop Alignment

- a. If you are doing a V-Fold, you do not have to set the paper stop on the Lower Fold Plate.
4. Make sure that the paper stop is set up square by double-checking that the scales on both sides show the same fold selected or the same inch reading.
 5. Tighten the thumbscrews, being careful that the paper stop does not slide out of square.
 6. Return the Fold Plate to the machine, making sure it is resting properly on the placement pins.
 - a. If you are doing a V-Fold, replace the *Lower Fold Plate* backwards, so that the flat face is facing in and the slot is facing out.

For a custom form, the fold plate scales measure distance in inches from the fold, so the paper stop can be set to the appropriate measurement. If you are unclear about which figures to use, measure the lengths of the folds on your form (the distance from the perforations or fold marks to the edge of the paper) or contact your sales rep for more information.

Machine Operation

Loading the Feed Table

Before loading the feed table, square up the stack of paper you are going to load by placing it on edge on a flat surface. Place the stack onto the table so the front of the stack butts up against the feed gauge cover (*do not push hard*).

The proper orientation of the paper when loaded onto the feed table depends on the type of fold you are doing and the layout of your form. The diagrams below show the order in which folds will be performed when run through the machine with the right-hand paper edge being loaded into the machine first (red arrow shows paper path).

All forms should be loaded with glue on the leading edge facing up (the glue is usually visible as yellow, blue or red stripes around the edge of the form). With *Z-* and *EZ-Folds* you have multiple ways to load the form and still have glue on the leading edge facing up, either one will work. With *EZ-Folds* though, care must be taken to ensure the upper fold plate is set to the proper length for the leading fold (the bottom fold plate setting remains the same either way).

Feed Table Capacities

11" Forms: 150 Sheets; 14" Forms: 100 Sheets

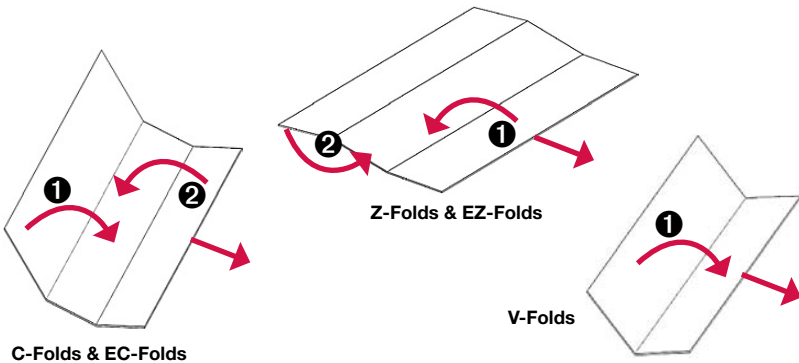

Operating the PSM10K

The **PSM10K** can operate in two modes: Manual and Batch.

- **Manual Mode:** the machine runs forms and keeps a running count until stopped by the operator.
- **Batch Mode:** the *Batch Total* is set and the machine runs forms until the *Batch Total* is reached, at which point the machine stops.

Operating in Batch Mode (optional counter)

To enter *Batch Mode*, press the *Mode* button until the screen displays *Batch Mode* (Figure 14).



Figure 14: Batch Mode

Setting the Batch Total

1. Make sure that the machine is in *Batch Mode*
2. Use the *Up* or *Down* button to change the *Batch Total* (displayed in the lower right corner of the screen). Both buttons can be held down to continuously change the count, and if the change is over 20, holding the button down causes the count to change in steps of 10, though at this point releasing and pressing the button once will still increase the count one at a time.
3. Press the *Mode* button once to lock in the number.

Running in Batch Mode

When the *Batch Total* is set, press the *Run* button to start the machine. The machine will run and the *Batch Count* of forms processed will be displayed in the middle of the lower line of the screen (Figure 14). Press *Stop* to stop the machine. This will not reset the *Batch Total* or the *Batch Count*. Press *Run* again to start the machine.

Machine Operation

Resetting the Batch Count

The *Batch Count* is the running tally of forms processed for this batch. To reset it during or at the end of a batch, press the *Clear* button. The screen will ask you to confirm the reset by pressing the *Clear* again. Pressing any other button will cancel the reset.

Operating in Manual Mode

To enter *Manual Mode*, press the *Mode* button until the screen displays *Manual Mode* (Figure 15).

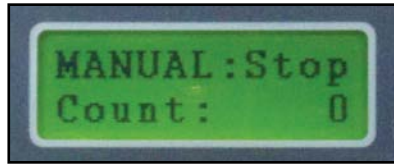

Figure 15: Manual Mode

Resetting the Count

To reset the count when in *Manual Mode* press the *Clear* button.

Maintenance

Regular maintenance on the **PSM10K** will ensure the machine continues to function properly and will extend the life of the machine. Perform the following steps every 10,000 forms or once a month:

1. Disconnect the power cord from the machine.
2. Remove both fold plates.
3. Vacuum any paper dust or toner that has accumulated on the feed table and on the rollers.

 **Make sure that the power cord has been disconnected before continuing!**

4. Open the access panel in the side cover opposite the control panel.
5. Insert the 7/16" socket at the end of the breaker bar (*inside the tool box*) over the hex shaped end on the #3 roller (*Figure 10, page 13*). This bar can now be used to rotate the rollers.
6. Clean the *stainless steel rollers* with a household cleaner to remove any accumulated toner. As you clean, use the breaker bar to rotate the rollers so that the entire roller surface is cleaned.
7. Clean the *rubber rollers* and the *feed belts* using a *rubber roll rejuvenator* (available at your local office supply store). Use the breaker bar to rotate the rolls and feed belt as you clean so all the rubber surfaces are cleaned.
8. Return the breaker bar to the tool kit and replace the access panel.
9. Replace the fold plates.
10. Make sure that the *power switch* is in the *OFF* position.
11. Connect the power cord to the machine.

Automatically Clearing a Paper Jam

If paper becomes jammed in the machine:

1. Remove all paper from the *Feed Table*.
2. If the *Breaker Power Switch* has tripped (*light is off*), flip to the ON (lit) position.
3. Remove the *Lower Fold Plate*.
4. Press the *Reverse* button.
5. The paper should exit from the back (*where the lower fold plate normally sits*). If it doesn't, try pressing the *Reverse* button again. If the paper is not moving or you cannot see it, then you need to manually clear the jam (*see next section*).
6. Replace the Lower Fold Plate.

Manually Clearing a Paper Jam

1. Disconnect the power cord from the machine.

 **Make sure that the power cord has been disconnected before continuing!**

2. Remove all paper from the *Feed Table*.
3. Remove the *Lower Fold Plate* from the machine.
4. Remove the access panel in the side cover.
5. Place the *Breaker Bar* socket (*inside the tool box*) over the hex end of the #3 roller (*Figure 10, page 13*).
6. Rotate the breaker bar clockwise until the jammed form is out of the machine.
7. Replace the lower fold plate.
8. Replace the paper on the feed table.
9. Return the breaker bar to the tool kit.
10. Replace the side cover access panel.
11. Make sure that the *power switch* is in the *OFF* position.
12. Connect the power cord to the machine.

Troubleshooting

Diagnosing the Paper Jam

The table below outlines the different problems which cause paper jams and the symptoms which will help you to identify the cause.

Paper Jam Troubleshooting

	Double Feed	Buckled Form	Bad Fold
Causes	<i>Two forms folded together</i> <ul style="list-style-type: none">• Bad feed gauge setting• Too much paper on feed table	<i>Extra fold in the form</i> <ul style="list-style-type: none">• Wrong fold plate setting	<i>Form is crooked</i> <ul style="list-style-type: none">• Feed table paper guide set improperly• Fold plates set improperly
Solution	Turn feed gauge screw 1/4 CCW	Check both fold plates to ensure they are set to the correct mark on the scale	Check both fold plates to ensure that both paper stops are square

Misaligned Folds

If your forms are running through the machine OK but they're folding a little bit crooked or are not folding right on the perforation, you need to tweak the fold plate settings. The location of perforations on forms generally fluctuates by about 1/16" in either direction. Forms manufacturers do this to avoid the forms sticking together too much. Because of this fluctuation, it is sometimes necessary to fine tune the placement of the paper stop on one of the fold plates. The first step is to identify which fold plate is misaligned. Watch the form as it is fed into the machine, and then compare it to the finished form. If you're having trouble visualizing which fold is off, refer to the section *Loading the Feed Table (page 16)*.

Once you've identified which fold plate needs to be adjusted, remove it from the machine. If the fold is crooked, check to make sure that the paper stop is parallel to the front edge of the fold plate. Check that the indicator points on the paper stop indicate the same reading on the two scales of the fold plate. Also check the feed table to make sure that paper guides are snug against the paper stack. If the fold is just a bit off of the perforation, adjust the paper stop by the amount that the fold is off. If the fold is happening early, then move the paper stop away from the open end of the fold plate. If the fold is happening late, then move the paper stop towards the open end of the fold plate.

Paper Feed Problems

Double Feeds

If you're having problems feeding two forms at a time occasionally:

1. Turn the *Feed Gauge Adjustment Screw* 1/4 turn counter-clockwise.
2. Try running the forms again.
3. If the problem persists:
 - a) Try another 1/4 turn on the *Feed Gauge Adjustment Screw*.
 - b) Try reducing the size of the paper stack on the *Feed Table*.
 - c) Try resetting the *Feed Gauge*.

Machine Won't Feed

If your machine won't feed forms through:

1. Try reducing the size of the paper stack on the *Feed Table*.
2. Try resetting the *Feed Gauge*.
3. Check for toner build-up on *Feed Belts*.

Machine Won't Run

If your machine won't run when the run/stop switch is operated:

1. Check that the machine *Breaker Power Switch* is not in the tripped position. If it is, press it in. If the breaker button will not stay pressed in, wait a minute and try again.



800.464.5030
psmailers.com