

Vino Series Post System with Standoff Bracket

Installation guide for Vino Series Post with FCP-2WB Brackets



3D INTERACTIVE INSTRUCTIONS

USE BILT TO ASSEMBLE WITH CONFIDENCE

For fast 3D step-by-step instructions,
download the free BILT app!



Available on most iOS and Android Devices

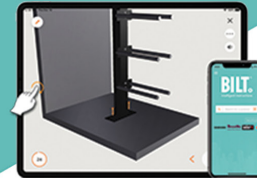

BILT.
Intelligent Instructions

Included:

- (1) Extension Bracket
- (1) Drill Bit
- (1) Self Drilling Screw

- 96 Mounting Plate screws
- Vino Series Post Mounting Plates with Self-Drilling Screws
- Vino Pins or Vino Rails

- Level
- Pencil or Marker
- Tape measure
- Metal cutting saw
- Metal file
- Square
- Rubber Mallet (optional)

Additional Components:

(sold separately)

- (1) 62" Post Bottom (c-Channel)
- (1) 62" Post Top

Required Tools:

- Drill
- Phillips head drill bit
- Phillips head screwdriver

Important Note:

These installation instructions will assist you with installing the VintageView Vino Series Post System with a 2" Standoff Bracket to allow for an installation from floor to wall at a 2" offset and up to 10' (3048mm) tall. The Standoff Bracket is suitable for wall-to-ceiling or wall-to-wall mounting when using only one side of a Post or in conjunction with a Vino Series Post Vertical Extension Bracket.

Fasteners:

Fasteners for securing Mounting Plates to the Vino Series Posts are provided (self-drilling screws). Each mounting Plate is pre-drilled for installing Post. When installing finished Vino Series Post to the floor or wall, please use the following recommendations for fasteners:

Guidelines for Floor/Ceiling Hardware

Wood/Stud: #8 x 1-1/4" course thread screws (or longer)

Concrete, Brick, or Stucco: 3/16" x 1-1/4" masonry screw or #8 x 1- 1/4" screw with appropriate size expanding anchor

Drywall: Expanding hollow wall anchors with at least #8 screw size



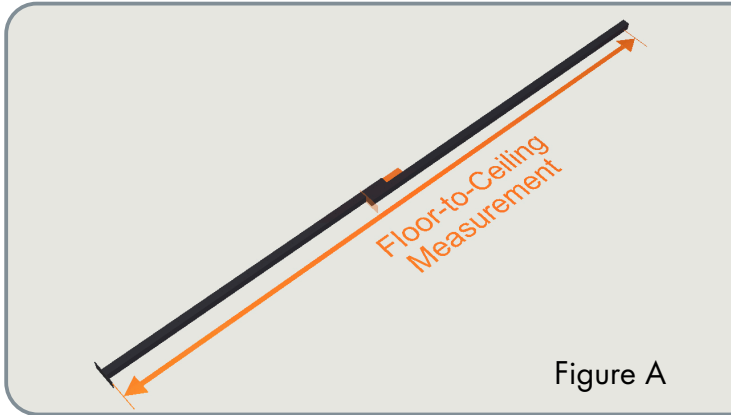

Figure A

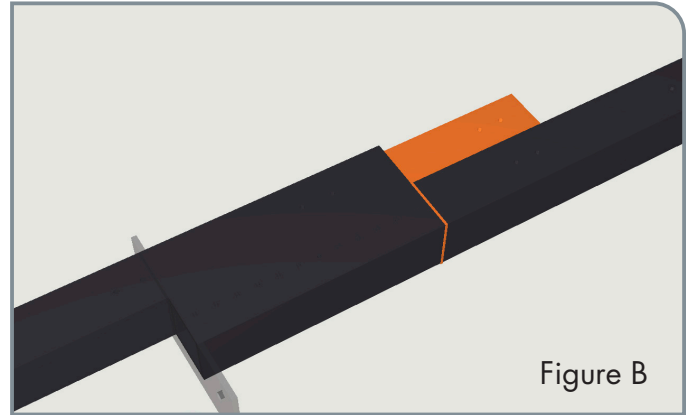

Figure B

1. IDENTIFY PROPER HARDWARE

Using the chart on the previous page, identify the proper floor/wall hardware (not included) that will be needed for your specific project. For drywall surfaces in floor or ceiling, VintageView recommend installing to joists or wood backing when available.

2. MEASURE INSTALLATION HEIGHT

Measure the height from the floor to the desired wall mounting location.

3. MARK THE POST

Lay the Top Post, Mounting Bracket down, next to the Post Bottom, interlaced (Figure A). Position the two sections so that the measurement from top to bottom of the base plates equals your installation height.

Subtract 1/8" (3.5mm) from the overlap to account for height of Standoff bracket (1/4" [7mm] if using two). Use a pencil or marker to mark any overlap on the bottom of the connected Post Top (Figure B).

Do not mark/cut from the end with the C-Channel extruding out.

4. CUT THE POST

Using a Metal Cutting Saw, squarely cut the Bridge Post at the Mark (Figure C). *Do not use abrasive saws as they may damage the finish.*

5. CONNECT THE POST

Slide the Post Top Section onto the C-Channel in the Post bottom (Figure D). It may require a Rubber Mallet to connect fully.

6. MARK MOUNTING PLATE HOLES

Lay the first wine rack Mounting Plate in the desired location on the Post (Figure E). Mark two (2) mounting

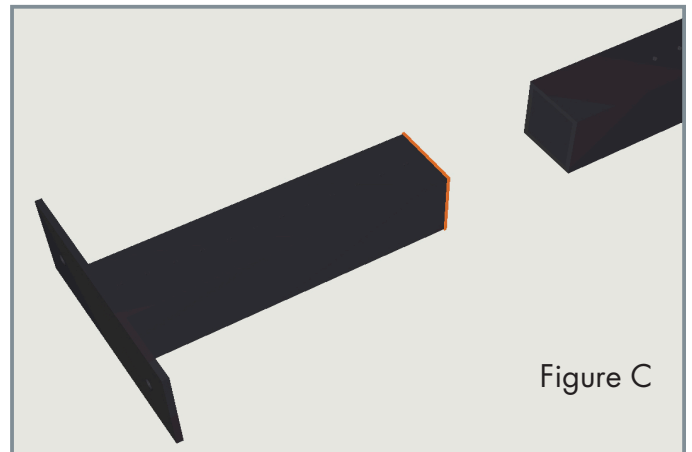

Figure C

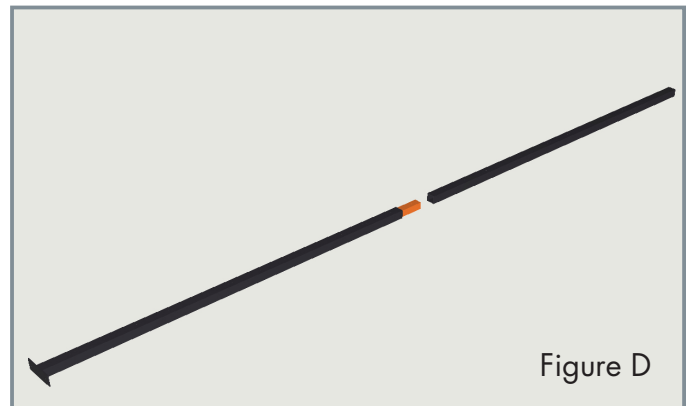

Figure D

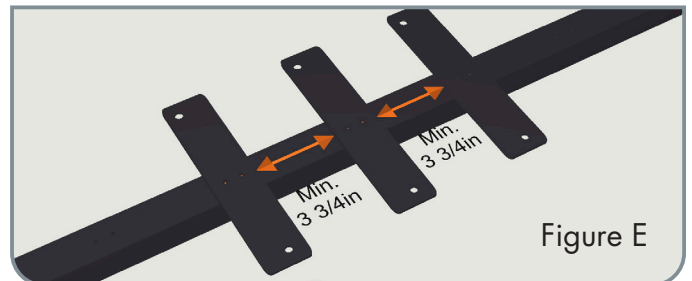

Figure E



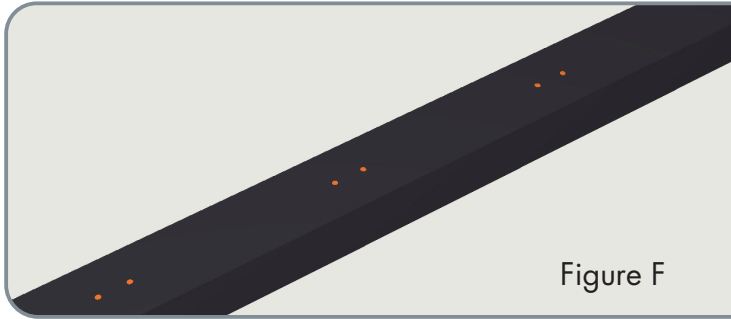

Figure F

hole locations. Mark the holes for the next Plate ensuring a minimum of 3-3/4" vertical clearance from one Plate to the next (Figure E). Use a Level and a Square to ensure Plates are Level. Set the plate to the side.

NOTE: Plates can be installed to only the front side when using a Standoff Bracket.

7. PRE-DRILL MOUNTING HOLES

Using the provided Drill Bit, pre-drill all marked mounting hole locations (Figure F).

8. ASSEMBLE AND THE PLATES

For Vino Pins

Mounting Plates are sold in two unique widths: one for standard 750ml or Champagne bottles and one for magnum 1.5L bottles.

(Optional) Assemble the Vino Pins and Vino Pins Extensions (Figure G) to reach desired bottle depth (up to 3 bottles deep for 750ml bottles and up to 2 bottles deep, with spacer, for Magnum bottles).

Fasten the Vino Pins to the Mounting Plates using provided M6 Screws (Figure H).

Ensure the higher mounting hole in the Mounting Plate points in the direction you want the bottle neck to face. Fasten the Vino Pins Neck (slimmer bottle impression) piece to the higher of the two holes.

For Vino Rails

Mounting Plates are sold in standard 750ml or Champagne bottles and magnum 1.5L bottles configurations, each with choice of single, double, or triple bottle width. Thread all Vino Rails to the Mounting Plates using the provided M6 Screws (Figure I).

NOTE: If installing Vino Rails Magnum wine racks, do not insert supplied Bridge until the entire installation is finished.

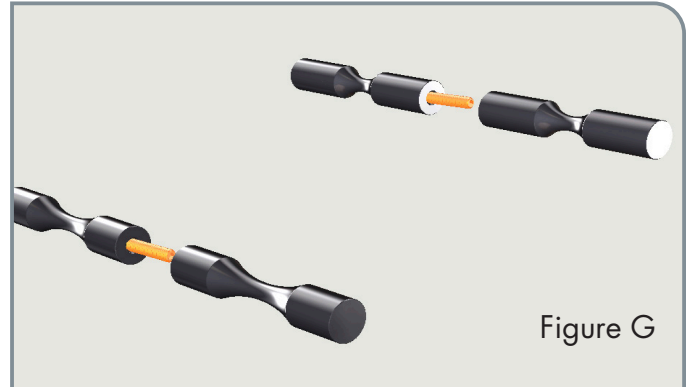

Figure G

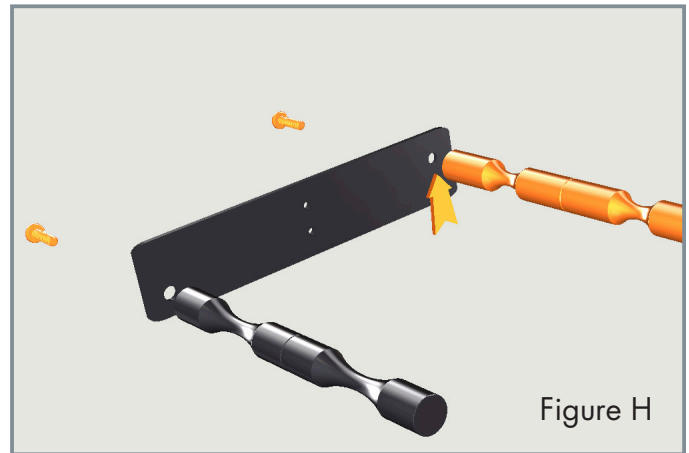

Figure H

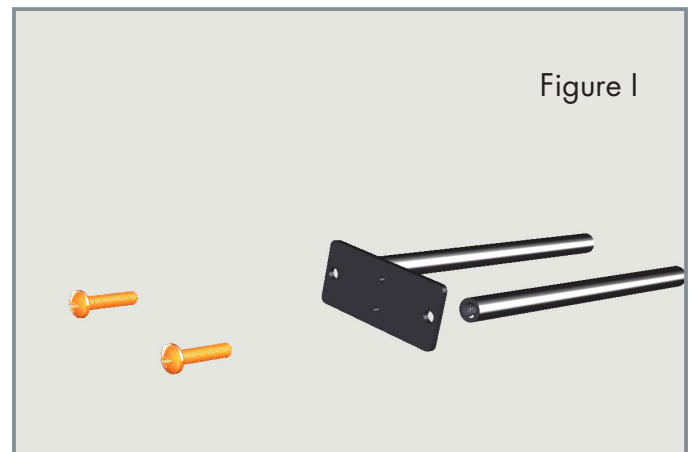

Figure I

9. INSTALL THE PLATES

Attach one (1) assembled Mounting Plate to the Post using two (2) provided Self-Drilling Screws into the pre-drilled holes (Figure J). Repeat the previous step to attach the remaining Mounting Plate assemblies.

10. INSERT STANDOFF BRACKET

Insert the Standoff Bracket into the Post Top (Figure



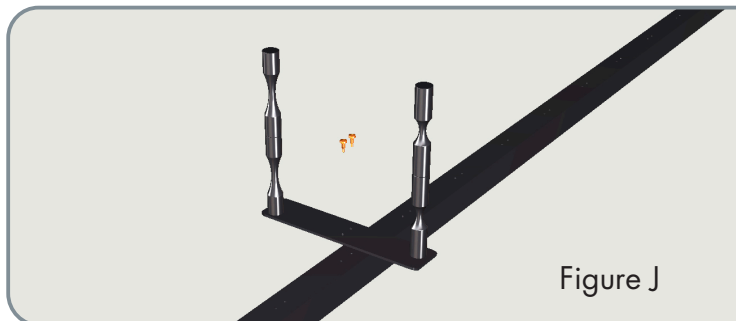

Figure J

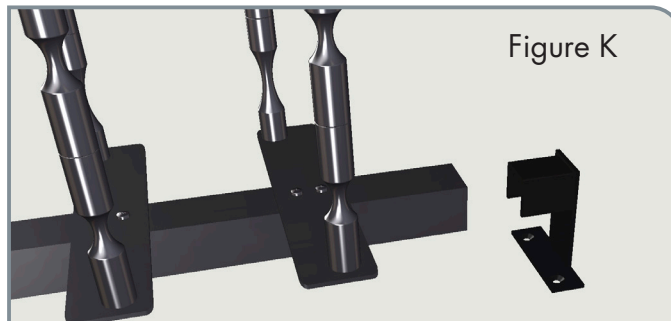

Figure K

K). The Standoff Bracket will fit square in the Post when installed. A Rubber Mallet may be needed to connect fully.

11. SECURE THE BRACKET

Using the provided Drill Bit, drill through Post and Bracket ensuring the drill hole point goes through one of three sides of the Bracket c-Channel. Thread provided Screw to secure the Post and Extension Bracket (Figure L).

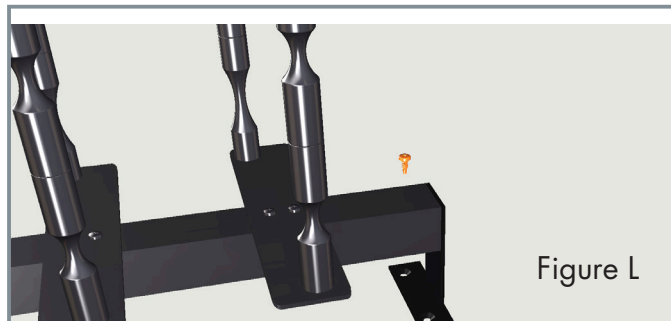

Figure L

12. MARK MOUNTING HOLES

Place the assembled Post in the desired location. Ensure it is plumb with a level and mark the mounting holes on the wall and floor. Set the Post aside and drill any required pilot holes based on choice of wall/floor mounting hardware (not provided).

13. INSTALL THE SYSTEM

Stand the Post Assembly in the desired location and ensure it is plumb both front and back and side-to-side with a level. Mark mounting holes on floor, ceiling, and wall. Set Post aside and pre-drill mounting holes.

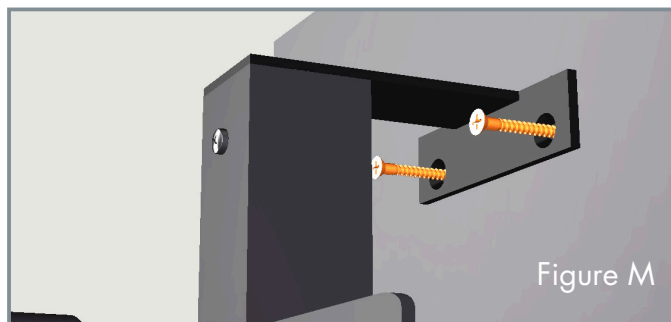

Figure M

Place Post back in place, ensuring it is level, and secure to the wall (Figure M) using two (2) of the appropriate fasteners (not provided). Double check the Post is plumb and secure the Post to the floor using two (2) of the appropriate fasteners (not provided).

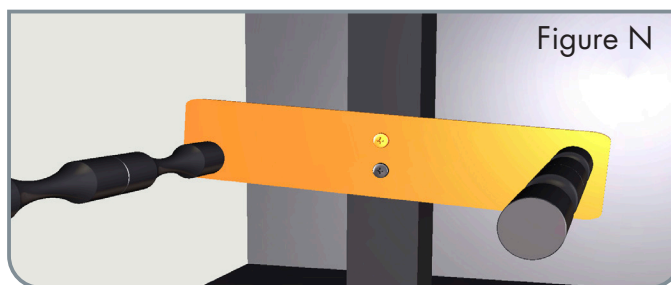

Figure N

If any of the Mounting Plates appear unlevel, loosen one (1) Screw slightly and reposition using a Rubber Mallet and Level (Figure N). Re-tighten the screw.

14. ADD WINE

Only the good stuff.

Problems?

Try using BILT 3D intelligent instructions, visit www.vintageview.com or call 303-504-9463.

Maintenance and Care:

Vino Pins or Rails should be regularly checked for tightness.

Should any rack to be found to be loose, tighten by hand until secure. All components of the Vino Series Post System may be cleaned with a damp cloth and mild dish soap. Abrasive pads or steel wool should NOT be used as they will damage the finished surfaces.

SCAN FOR BILT: 3D INSTRUCTIONS



POWERED BY BILT INTELLIGENT INSTRUCTIONS®

