

APPLICATION INSTRUCTIONS

FOR

PE FIT & FUN REUSABLE STENCIL PACKAGE

Product Number: SP-PE-003

Completely read "General Instructions." Prepare surfaces as recommended before painting.

This document contains Application Instructions for the following Reusable Stencils included in the **PE FIT & FUN REUSABLE STENCIL PACKAGE**:

1. TARGET PRACTICE: Product Number: 11-1W-012
2. SHAPES THAT SHAPE YOU UP: Product Number: 11-1W-004
3. RACETRACK: Product Number: 11-2W-019
4. FOUR SQUARE (LARGE): Product Number: 11-2W-015
5. CIRCLE UP (SMALL): Product Number: 11-1W-011
6. CIRCLE UP (LARGE): Product Number: 11-2W-010
7. BASKETBALL COURT KEY: Product Number: 11-3W-035

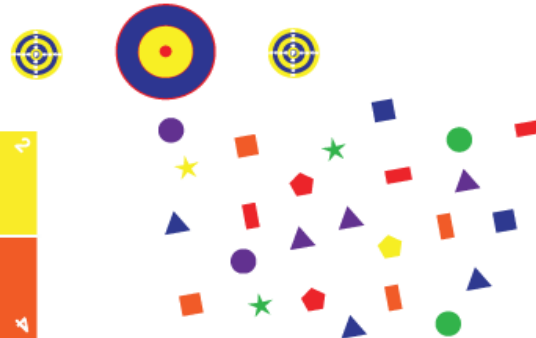
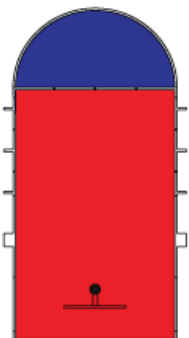
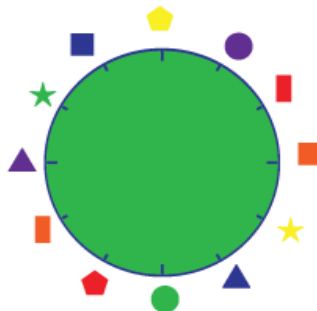
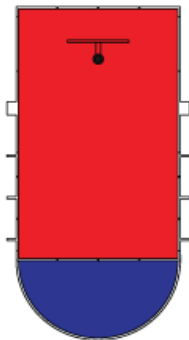

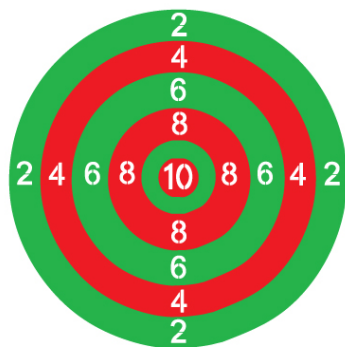

APPLICATION INSTRUCTIONS FOR THE **TARGET PRACTICE**

Product Number: 11-1W-012

SIZE: diameter (width) approximately 3 feet 7 inches
ESTIMATED PAINT TIME: approximately 1 – 2 people for 1 – 2 hours.

FIRST READ: Completely read "General Instructions". Prepare surfaces as recommended before painting.

1. Place STENCIL A in desired location and paint. Chalk out alignment holes at top. Repeat painting 1-2 more times to achieve desired vividness, drying after each application, and remove STENCIL A.

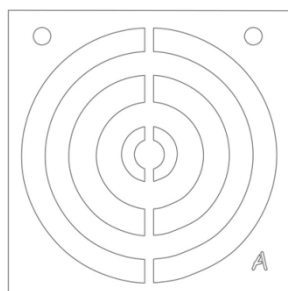

2. If desired, paint the gaps. You can use stencil for this by slightly rotating stencil so cut outs are positioned over the gaps. Repeat 1-2 more times to achieve desired vividness, drying after each application, and remove STENCIL A. It should appear as below.



- If desired, paint the remaining circles using same process of drying between applications. It should appear as below:

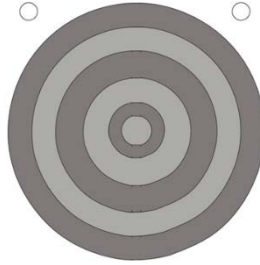

- Align STENCIL Busing alignment notes as shown below:

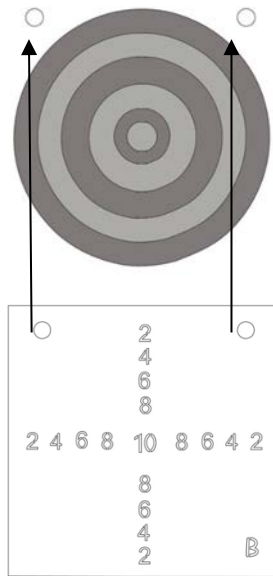

- Paint numbers. Repeat painting 1-2 more times to achieve desired vividness, drying after each application, and remove STENCIL
- Allow all paint to dry for a minimum of 24 hours before use.

Any questions? We're here to help – call us at (800) 681-0684!

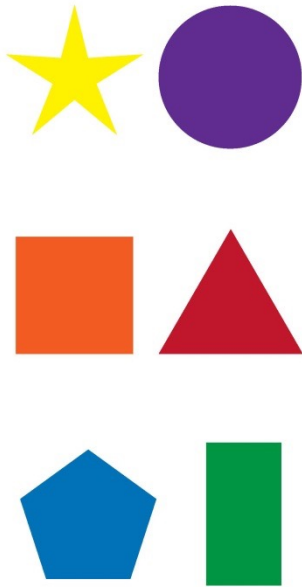

APPLICATION INSTRUCTIONS FOR THE **SHAPES THAT SHAPE YOU UP**

Product Number: 11-1W-004

SIZE: approximately 11.75 – 21 inches each

ESTIMATED PAINT TIME: depends on selected pattern.

FIRST READ: Completely read "General Instructions".
Prepare surfaces as recommended before painting.

1. Using various sized brushes or rollers, paint each stencil as desired. Repeat 1-2 more times to achieve desired vividness, drying after each application, and remove stencil. Allow to dry for 24 hours before use.

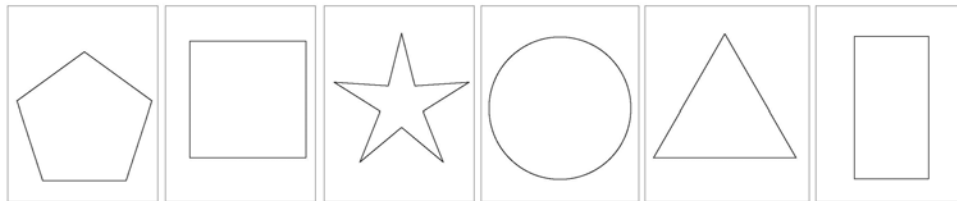

SEE OTHER APPLICATION INSTRUCTIONS FOR OTHER GAME IDEAS



APPLICATION INSTRUCTIONS FOR THE **SHAPES THAT SHAPE YOU UP LINE**

Product Number: 11-1W-004

SIZE: depends on desired spacing between each shape. One set of each shape spaced approximately 6 inches apart is approximately 12 feet 8 inches long. Width is 11.75-21 inches wide.

ESTIMATED PAINT TIME: approximately 1 – 2 people for less than 1 hour.

FIRST READ: Completely read “General Instructions”. Prepare surfaces as recommended before painting.

1. Arrange stencils in desired pattern with equal desired spacing between the sheets. Chalking may be needed for accuracy. The image below shows one of various patterns:

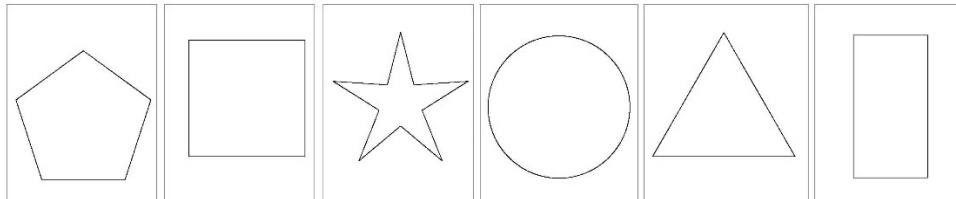

2. Using various sized brushes or rollers, paint each stencil as desired. Repeat 1-2 more times to achieve desired vividness, drying after each application, and remove stencil. Allow to dry for 24 hours before use.
3. Shapes can be reapplied to create longer lengths or different patterns. Letters or numbers can be painted after shapes are completely dry.

Any questions? We're here to help – call us at (800) 681-0684!

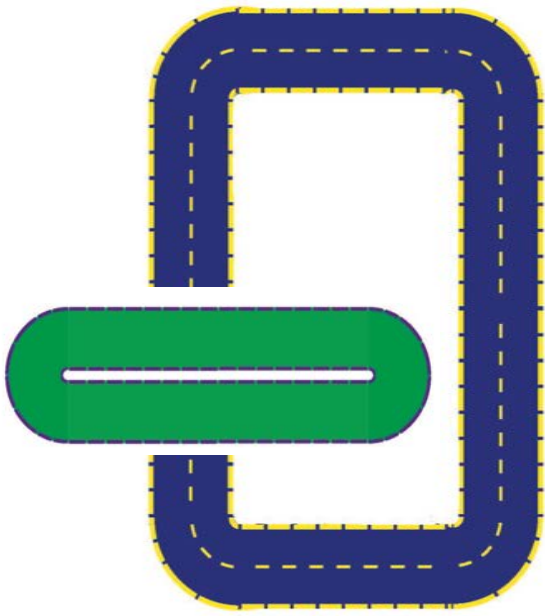

APPLICATION INSTRUCTIONS FOR THE

RACETRACK

Product Number: 11-2W-019

SIZE: Varies depending on desired pattern. Straight Track approximately 4 feet wide x 8 feet high. Half Circle approximately 4 feet wide x 8 feet high – Half Circle used to make Quarter Circle.

ESTIMATED PAINT TIME: depends on design.

FIRST READ: Completely read "General Instructions". Prepare surfaces as recommended before painting.

1. Place semi-circular stencil (STENCIL 1 or A) in the desired location.

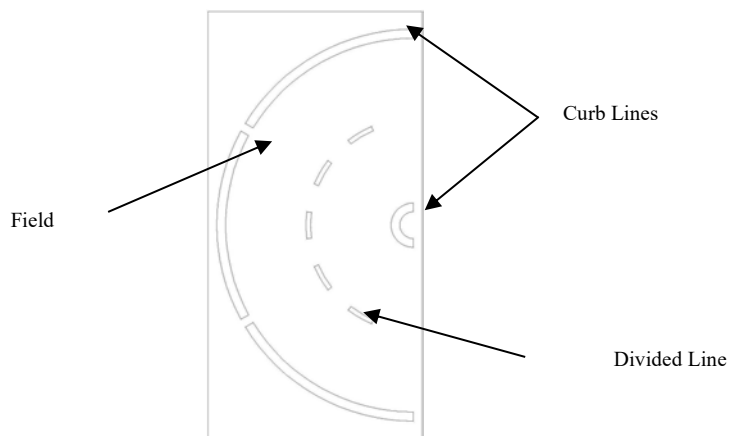

2. Paint Curb Lines and Divided Line. Repeat 1-2 more times to achieve desired vividness, drying after each application and then remove.

3. Align Curb Lines in straight stencil (STENCIL 2 or B) with Curb Lines painted on ground.

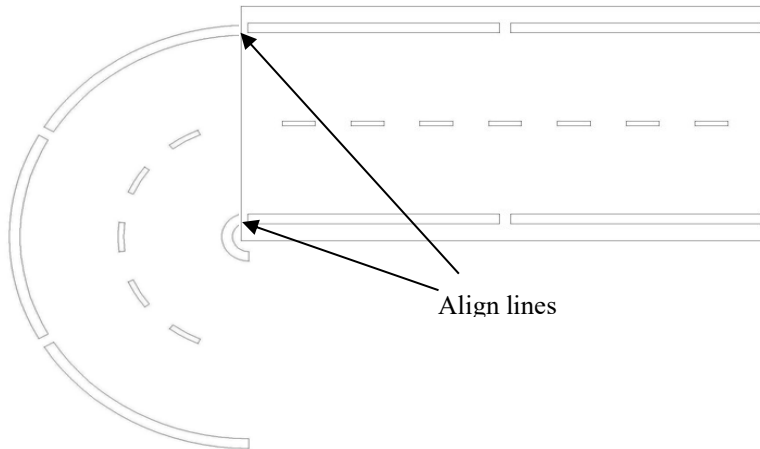

4. Paint straight stencil. Repeat 1-2 more times to achieve desired vividness, drying after each application and remove.

5. Repeat as desired, with one example shown below.

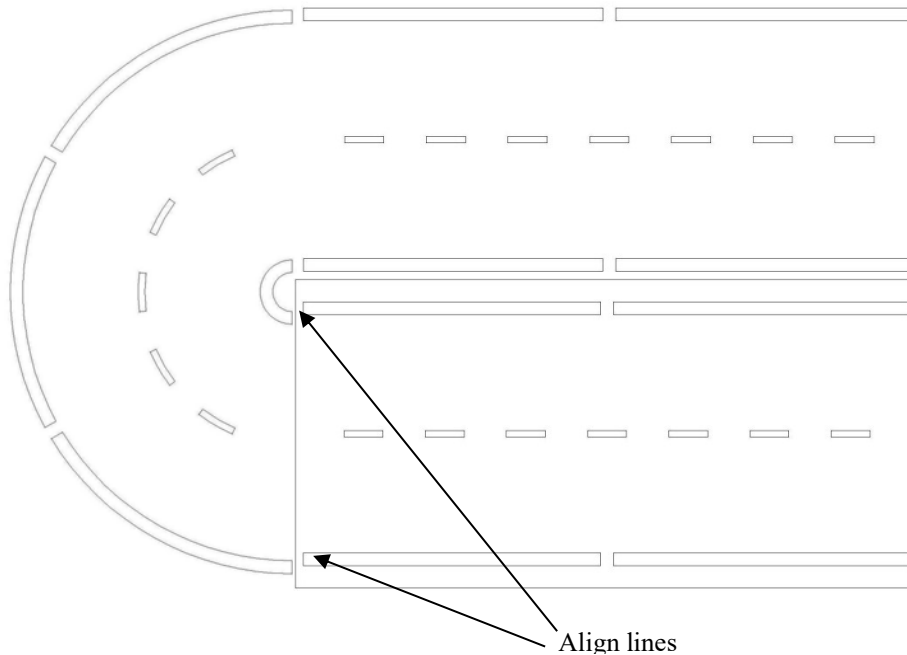

6. Repeat preceding steps until desired straight- run length of Racetrack is achieved.

- To close Racetrack, align Curb Lines of semi-circular stencil with Curb Lines of painted pavement as illustrated below:

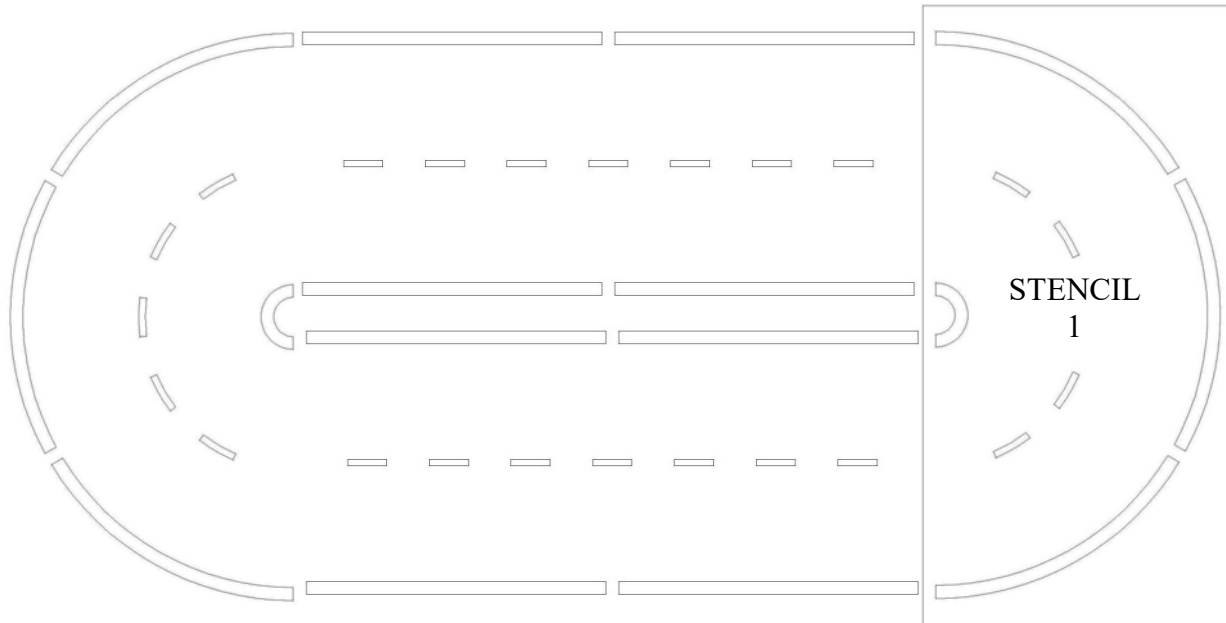

- Take a 2" brush to paint gaps along Curb Lines and Divided Lines. Paint the fields, in any color you prefer. Use 9" paint rollers and as you approach the edges of the lines, tip the roller, applying pressure to the end and carefully and slowly paint as close to the edge of the lines as possible. Repeat 1-2 more times to achieve desired vividness, drying after each application. Let completely dry.
- Allow all paint to dry for a minimum of 24 hours before use.

Any questions? We're here to help – call us at (800) 681-0684!

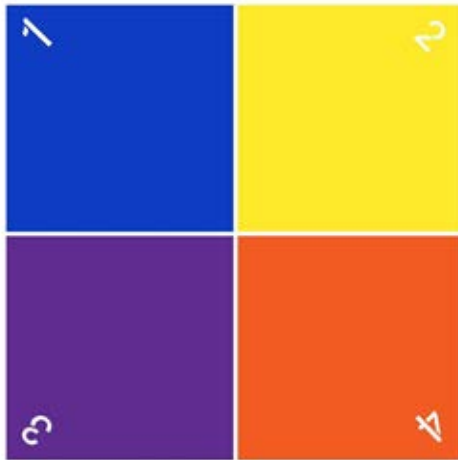

APPLICATION INSTRUCTIONS

FOR THE

FOUR SQUARE (LARGE)

Product Number: 11-2W-015

SIZE: approximately 16 feet each side

ESTIMATED PAINT TIME: approximately 2 – 4 people for 1 – 2 hours.

FIRST READ: Completely read "General Instructions". Prepare surfaces as recommended before painting.

1. Align STENCIL A and B along the edges as shown below and tape.

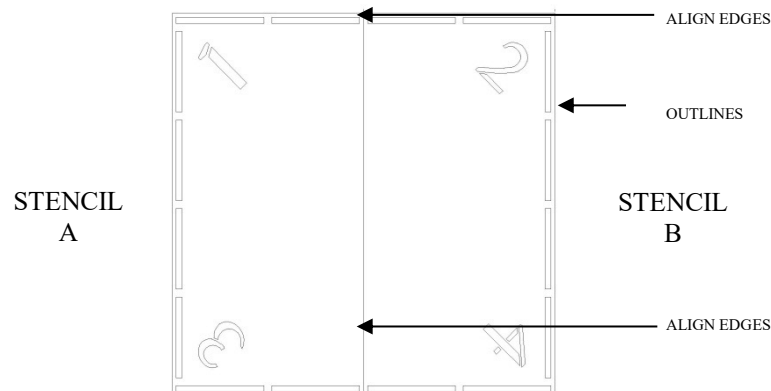

2. Paint **only** the outlines of each stencil. Repeat 1-2 more times to achieve desired vividness, drying after each application. Then, when fully dry, remove stencils. It should look like as follows:



3. Locate and align outline of STENCIL A over one side of the painted outlines, lapping over the dried painted outline. Tape and then align STENCIL B to STENCIL A and tape as shown below:

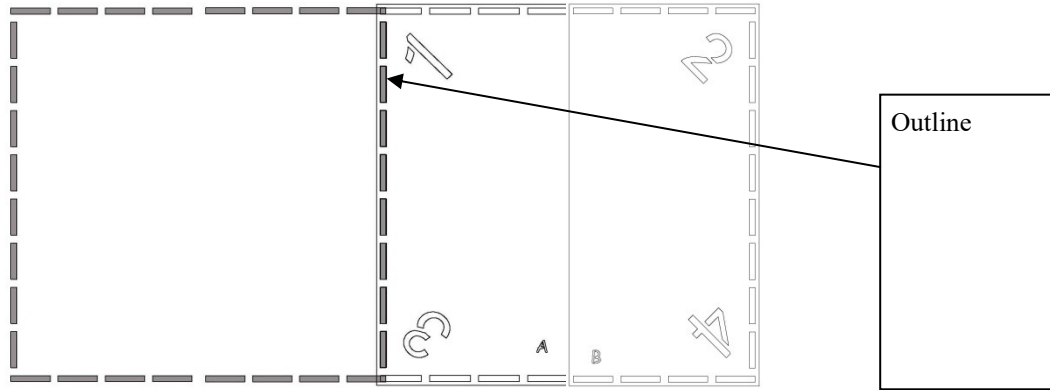

4. Paint **only** the outlines of each stencil. Repeat 1-2 more times to achieve desired vividness, drying after each application. Then when fully dry, remove stencils. It should look like as follows:

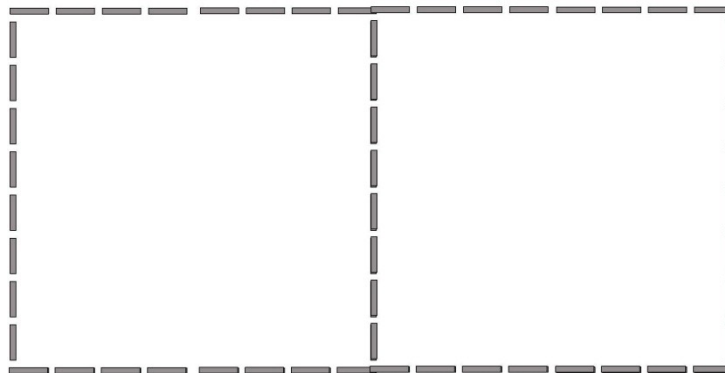

5. Complete other two quadrants of game as in steps 1-4 above until all four quadrants are painted. The painted pavement should look as follows:

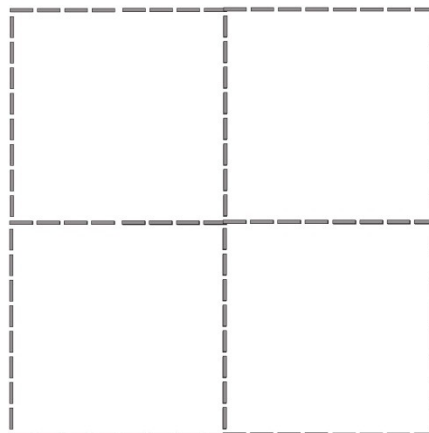

- Use 9" rollers to fill in the fields of each quadrant with desired paint. Repeat paint to achieve desired vividness, drying after each application.

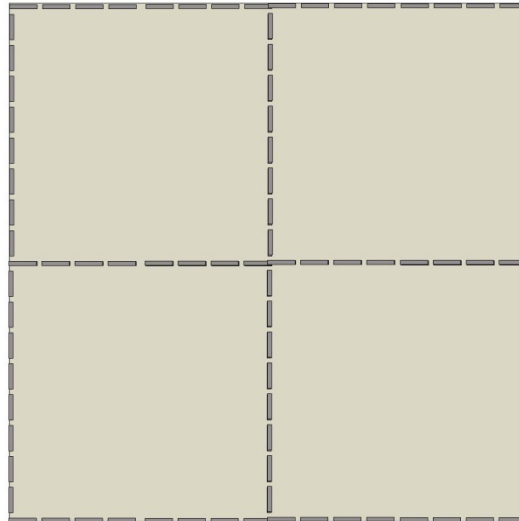

- Take STENCIL A and STENCIL B and align corners over painted pavement as shown below, one at a time. (Note that there are different sequences of numbers that are typically used – some position the “1” across from the “4”). Use small brushes to paint numbers, repeating to desired vividness and drying after each application. Remove each stencil when fully dry.

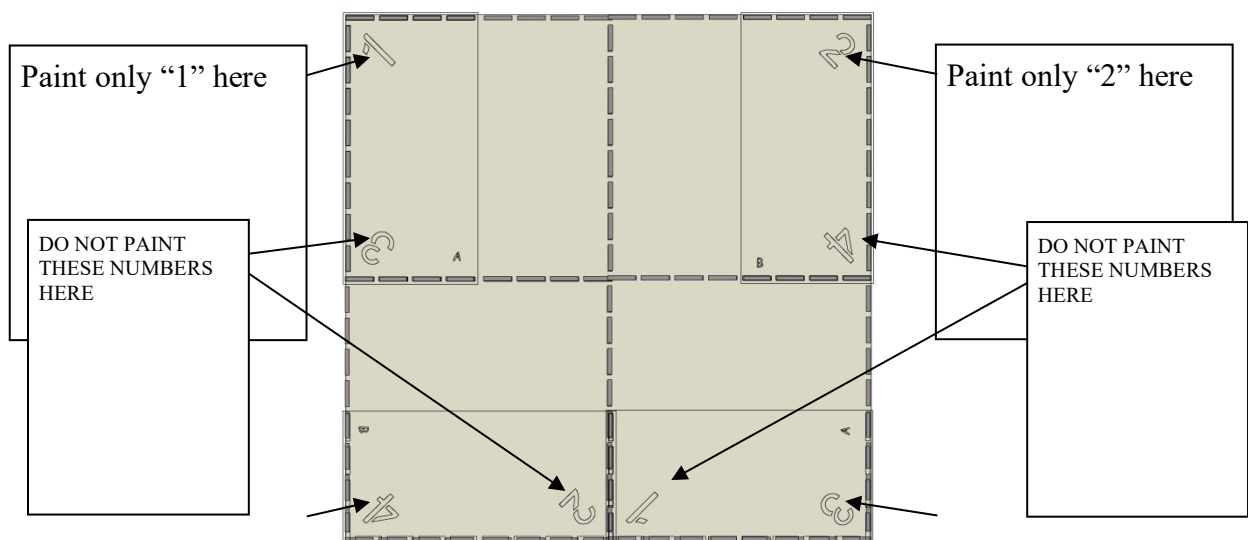

8. It should then look like illustration below. Use small brushes to fill in the gaps along outlines if desired.

Paint only "4" here

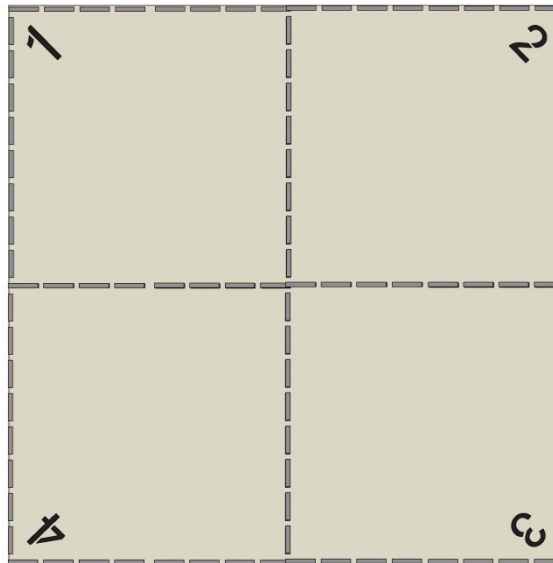

Paint only "3" here

9. Allow all paint to dry for a minimum of 24 hours before use.

Any questions? We're here to help – call us at (800) 681-0684!



THIS INFORMATION IS COPYRIGHT MATERIAL. ALL RIGHTS ARE RESERVED.
© 2017 FIT AND FUN PLAYSCAPES, LLC



APPLICATION INSTRUCTIONS

FOR THE

CIRCLE UP (SMALL)

Product Number: 11-1W-011

SIZE: diameter (width) approximately 7 feet 4 inches
ESTIMATED PAINT TIME: approximately 1 – 2 people for 1 – 2 hours.

FIRST READ: Completely read "General Instructions". Prepare surfaces as recommended before painting.

1. Place STENCIL A in desired location and paint. Repeat 1-2 more times to achieve desired vividness, drying after each application, and remove STENCIL A.

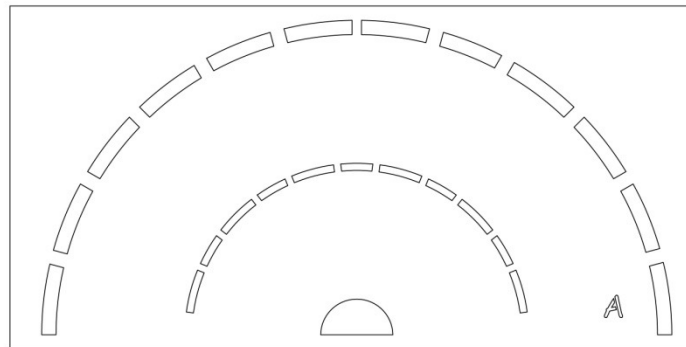

2. If desired, paint the gaps. You can use stencil for this by slightly rotating stencil so cut outs are positioned over the gaps. Repeat 1-2 more times to achieve desired vividness, drying after each application, and remove STENCIL A. It should appear as below.

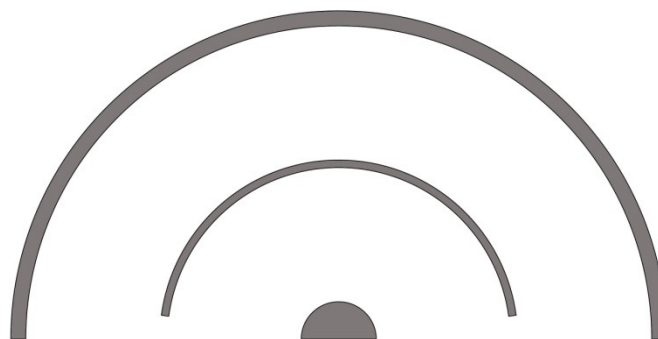

3. Take STENCIL A and rotate completely and match to painted circle ends as shown below.

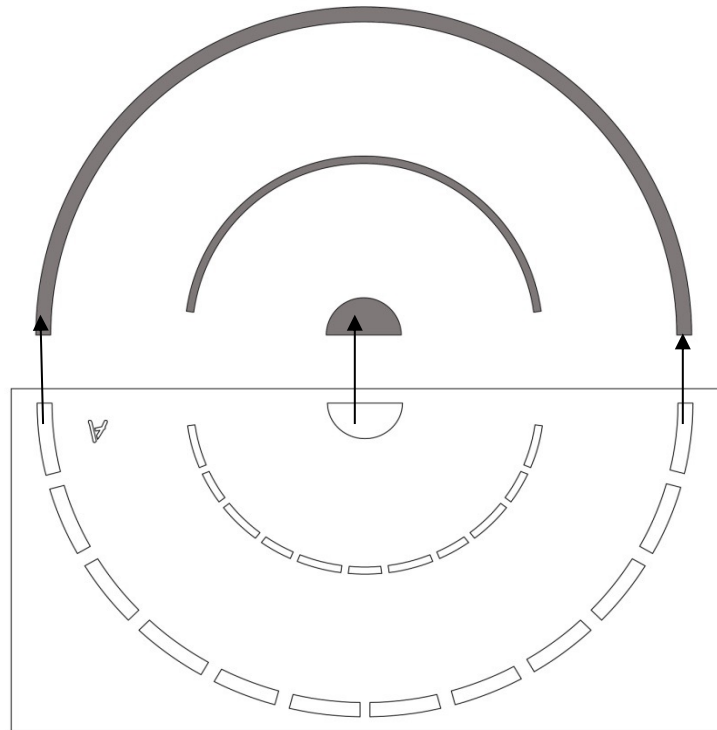

4. Paint as desired. Repeat 1-2 more times to achieve desired vividness, drying after each application. Rotate and paint gaps if desired.

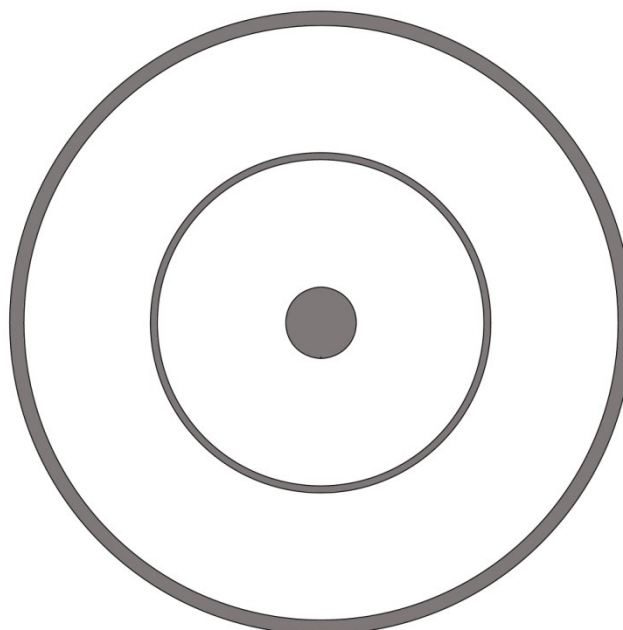

5. If desired, paint fields of circle as shown below. Repeat 1-2 more times to achieve desired vividness, drying after each application.

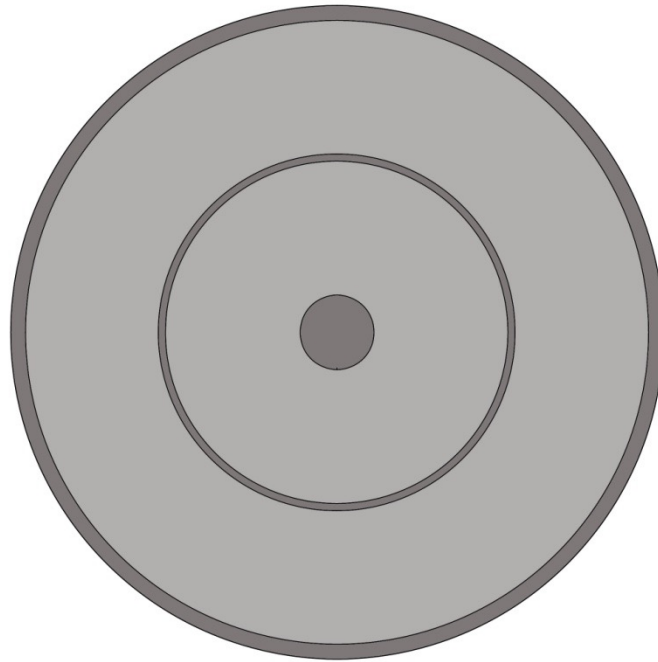

6. Allow all paint to dry for a minimum of 24 hours before use.

Any questions? We're here to help – call us at (800) 681-0684!



THIS INFORMATION IS COPYRIGHT MATERIAL. ALL RIGHTS ARE RESERVED.
© 2017 FIT AND FUN PLAYSCAPES, LLC

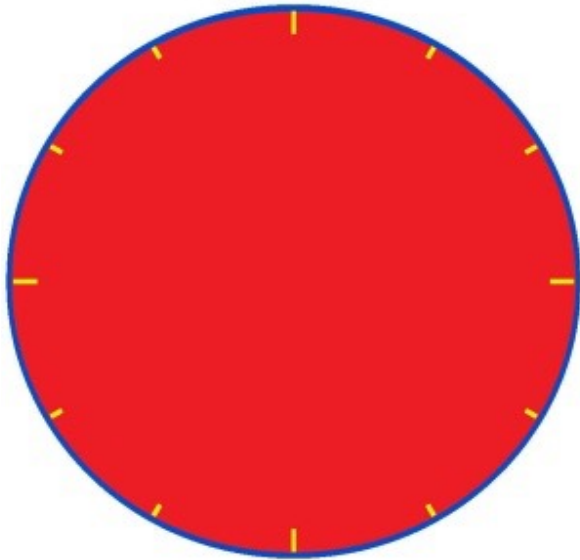

APPLICATION INSTRUCTIONS

FOR THE

CIRCLE UP (LARGE)

Product Number: 11-2W-010

SIZE: diameter (width) approximately 18 feet

ESTIMATED PAINT TIME: approximately 2 – 4 people for 1 – 2 hours.

FIRST READ: Completely read "General Instructions". Prepare surfaces as recommended before painting.

1. This stencil is composed of two (2) stencils as shown below. Familiarize yourself with the markings before proceeding as labeled below.

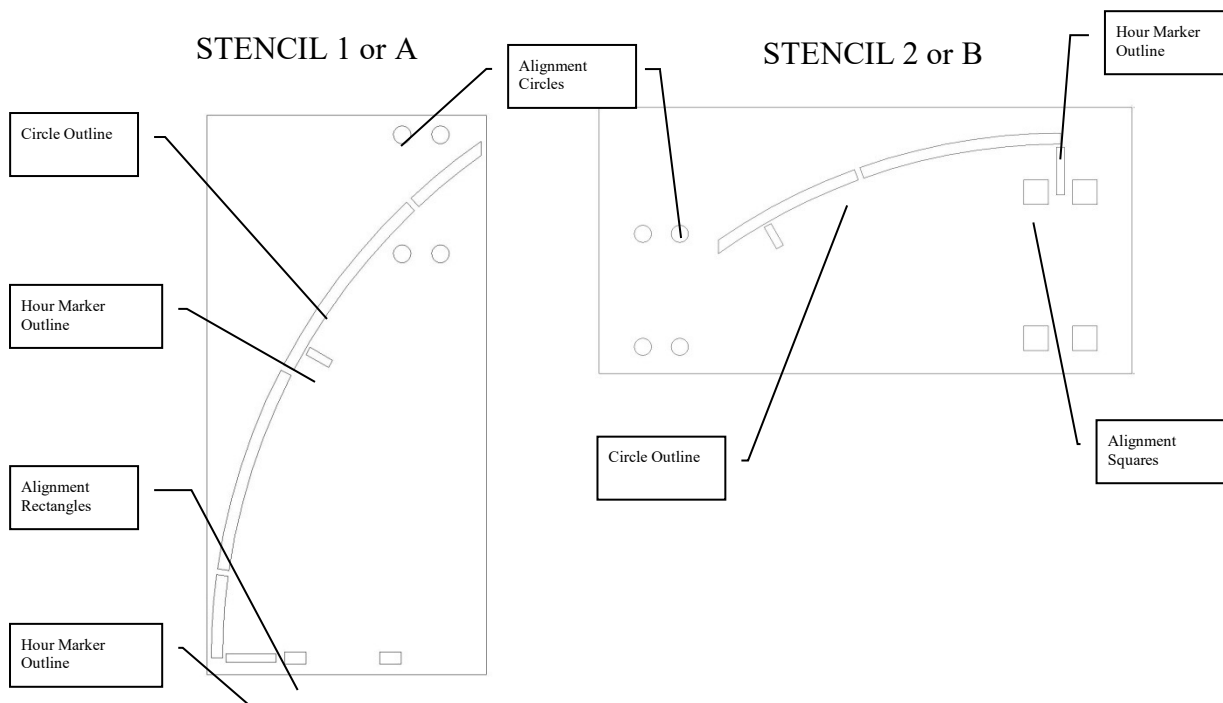

2. Locate the center point of the circle. To mark where the circle would generally be laid out take a piece of 9' string. Hold one end of the string at the centerpoint and position a piece of chalk at the other end of the string. While holding the end at the center point, and keeping the string taut, create a circle by rotating around the center point. This is recommended to ensure the approximate desired position of the stencils.
3. The next several steps require that the stencil be positioned, painted, dried and re-oriented (flipping over horizontally and vertically). Please note the following:



- a. When removing stencils, use one person positioned at each end of the stencil and lift at the same time. Do not roll the stencil or lift unevenly.
 - b. Use a 2" brush to paint the Circle Outline.
 - c. Use a 2" brush to paint the Hour Marker Outlines.
 - d. Re-paint the outline 1-2 more times at each step to achieve desired vividness.
 - e. Wipe stencil dry after each step and upon completion.
 - f. Familiarize yourself with the sequence of laying out the stencils as indicated on the following page and use during application for reference.
4. Position STENCIL 1/A to align along the marked line on the pavement. This is the starting stencil. Mark the Alignment Circles and Alignment Rectangles using chalk. Paint STENCIL 1/A, remove, lay on tarp and dry. Allow paint to dry.
 5. Take STENCIL 2/B and place adjacent to painted STENCIL 1/A, exactly matching the Alignment Circles. Mark the Alignment Squares with chalk. Paint STENCIL 2/B, remove, lay on tarp and dry. Allow paint to dry.
 6. Take STENCIL 2/B and flip over, making sure the surfaces are completely dry. Position STENCIL 2/B adjacent to painted STENCIL 2/B exactly matching the Alignment Squares. Mark the Alignment Circles with chalk. Paint STENCIL 2/B, remove, lay on tarp and dry.. Allow paint to dry.
 7. Take STENCIL 1/A and flip over, making sure the surfaces are completely dry. Position STENCIL 1/A adjacent to painted STENCIL 2/B exactly matching the Alignment Circles. Mark the Alignment Rectangles with chalk. Paint STENCIL 1/A, remove, lay on tarp and dry. Allow paint to dry.
 8. Take STENCIL 1/A and flip over, making sure the surfaces are completely dry. Position STENCIL 1/A adjacent to painted STENCIL 1/A exactly matching the Alignment Rectangles. Mark the Alignment Circles with chalk. Paint STENCIL 1/A, remove, lay on tarp and dry. Allow paint to dry.
 9. Take STENCIL 2/B and flip over, making sure the surfaces are completely dry. Position STENCIL 2/B adjacent to painted STENCIL 1/A exactly matching the Alignment Circles. Mark the Alignment Squares with chalk. Paint STENCIL 2/B, remove, lay on tarp and dry.. Allow paint to dry.
 10. Take STENCIL 2/B and flip over, making sure the surfaces are completely dry. Position STENCIL 2/B adjacent to painted STENCIL 2/B exactly matching the Alignment Rectangles. Mark the Alignment Circles with chalk. Paint STENCIL 2/B, remove, lay on tarp and dry. Allow paint to dry. Put STENCIL 2/B on tarp.
 11. Take STENCIL 1/A and flip over, making sure the surfaces are completely dry. Position STENCIL 1/A between the starting painted STENCIL 1/A and painted STENCIL 2/B, exactly matching the Alignment Circles and Alignment Squares. Paint STENCIL 1/A, remove, lay on tarp and dry. Allow paint to dry.

SEQUENCE FOR LAYING OUT STENCILS

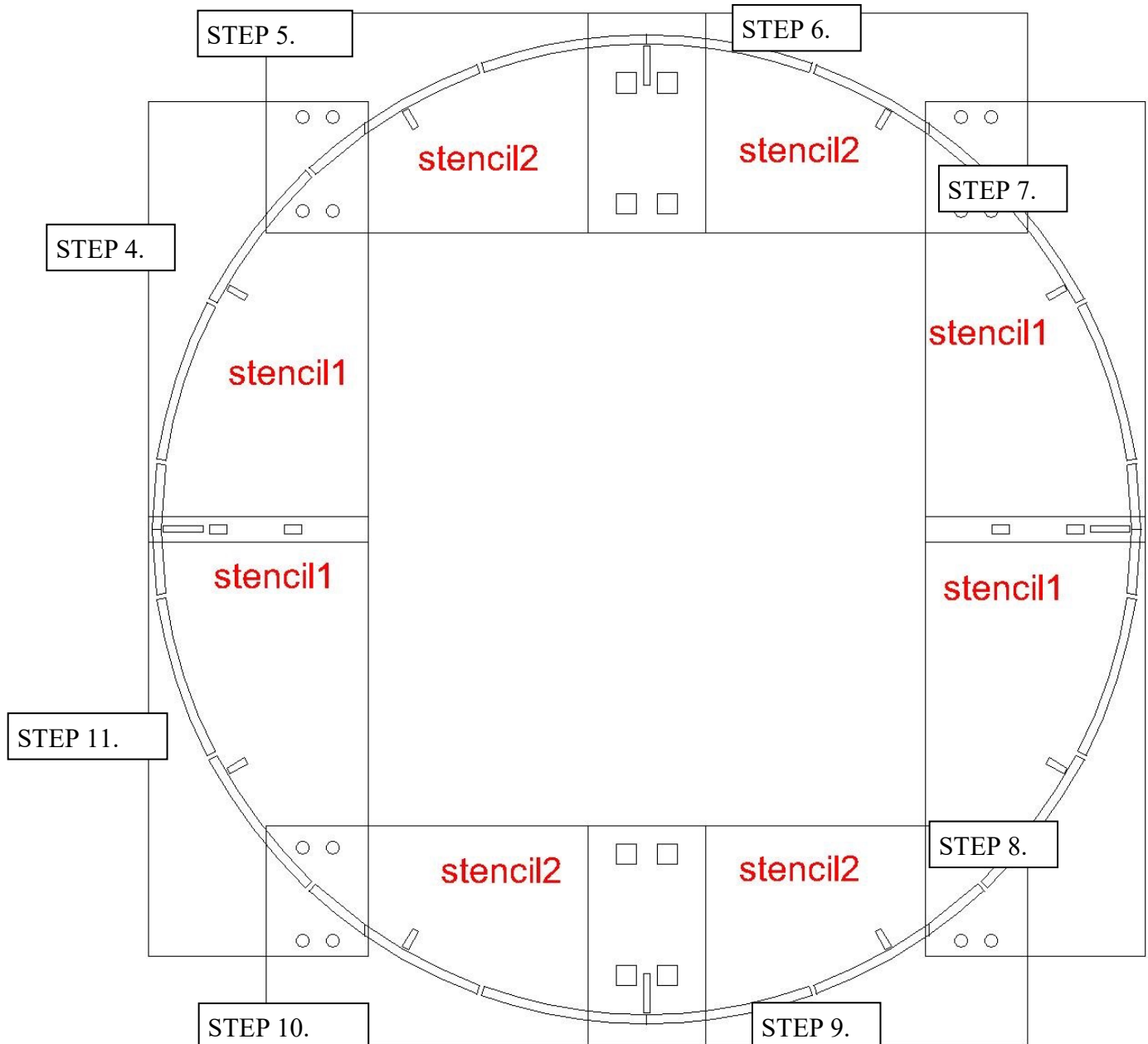



12. Touch-up the gaps between along the Circle Outline with paint, repeating 1-2 more times to achieve desired vividness.
13. Paint the field (inside) of the circle in any color you prefer. Use 9" paint rollers and as you approach the edges of the outlines, tip the roller, applying pressure to the end and carefully and slowly paint as close to the edge of the lines as possible. Repeat 1-2 more times to achieve desired vividness, drying after each application.
14. Allow all paint to dry for a minimum of 24 hours before use.

Any questions? We're here to help – call us at (800) 681-0684!



THIS INFORMATION IS COPYRIGHT MATERIAL. ALL RIGHTS ARE RESERVED.
© 2017 FIT AND FUN PLAYSCAPES, LLC

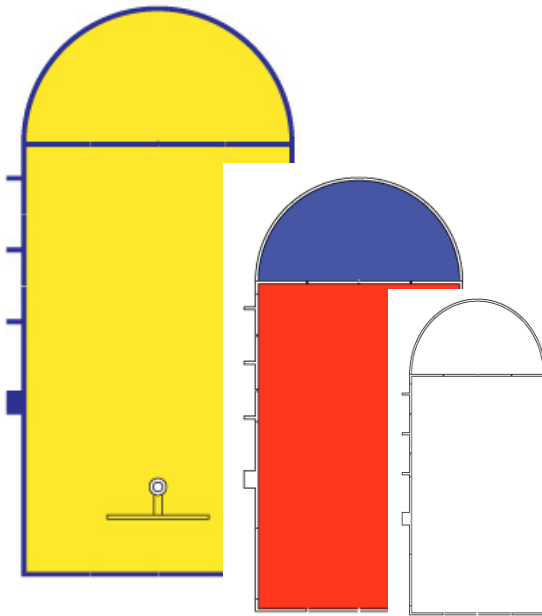

APPLICATION INSTRUCTIONS FOR THE **BASKETBALL COURT KEY**

Product Number: 11-3W-035

SIZE: approximately 25 feet long x 12 feet wide

ESTIMATED PAINT TIME: approximately 2-4 people for 1-2 hours.

FIRST READ: Completely read "General Instructions". Prepare surfaces as recommended before painting.

1. Locate "out of bounds" line which should be 4 feet behind the backboard and parallel to the backboard. For best application, use a chalk lines to mark out the bottom and sides of the basketball key. The court key should be 12 feet wide.
2. Align stencils as shown below to left, matching alignment holes as indicated. If using chalk lines, align outside lined cut outs of stencil to chalked lines. Tape all parts together if desired. Paint lines in place, repeating 1-2 more times to achieve desired vividness, drying after each application. Chalk out alignment holes on STENCILS C, E and end of D. Remove stencils. There will be gaps in the painted lines where the stencils overlap. To complete lines, re-align same stencils one at a time and paint incomplete lines using preceding stencils. The pavement should appear similar to illustration below right.

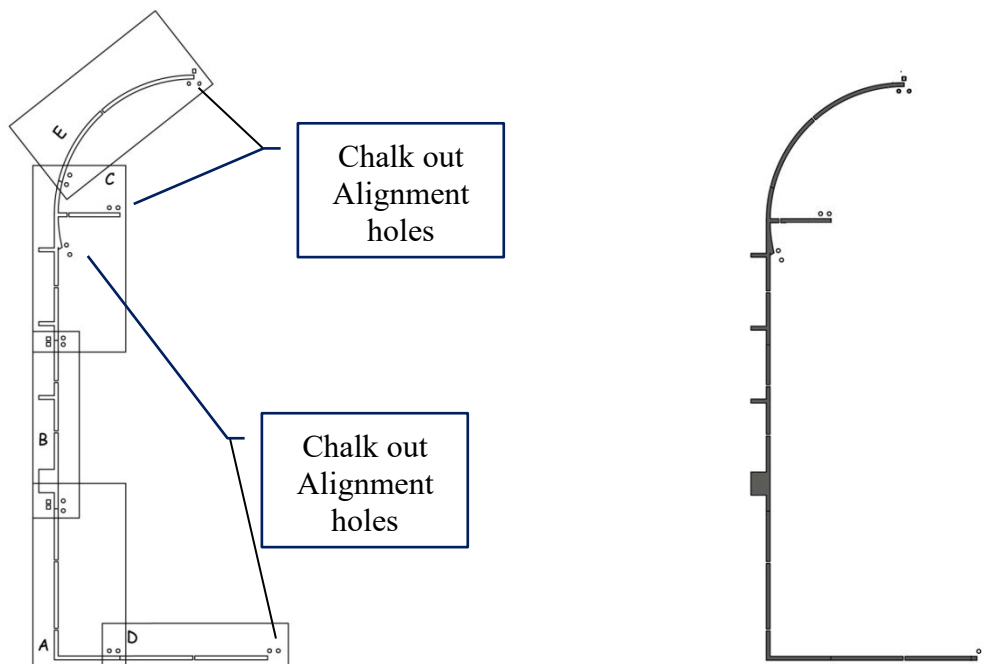

3. Beginning with STENCIL A, flip over and arrange stencils as shown below. Repeat directions from step 2. The pavement should appear similar to illustration below right. If full circle is desired, continued to step 4.

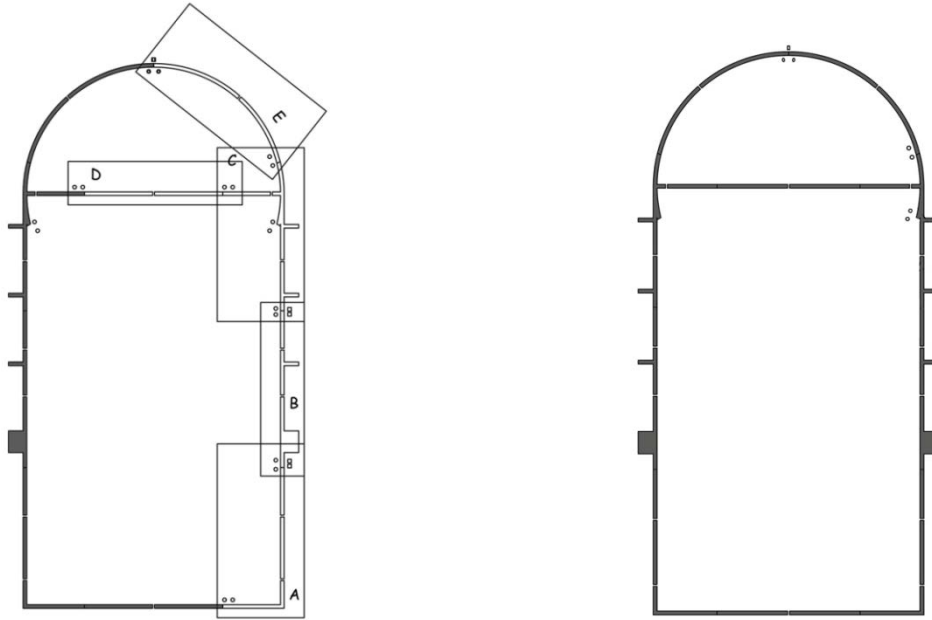

4. To complete circle, take STENCIL E and align and paint, as shown in steps below.

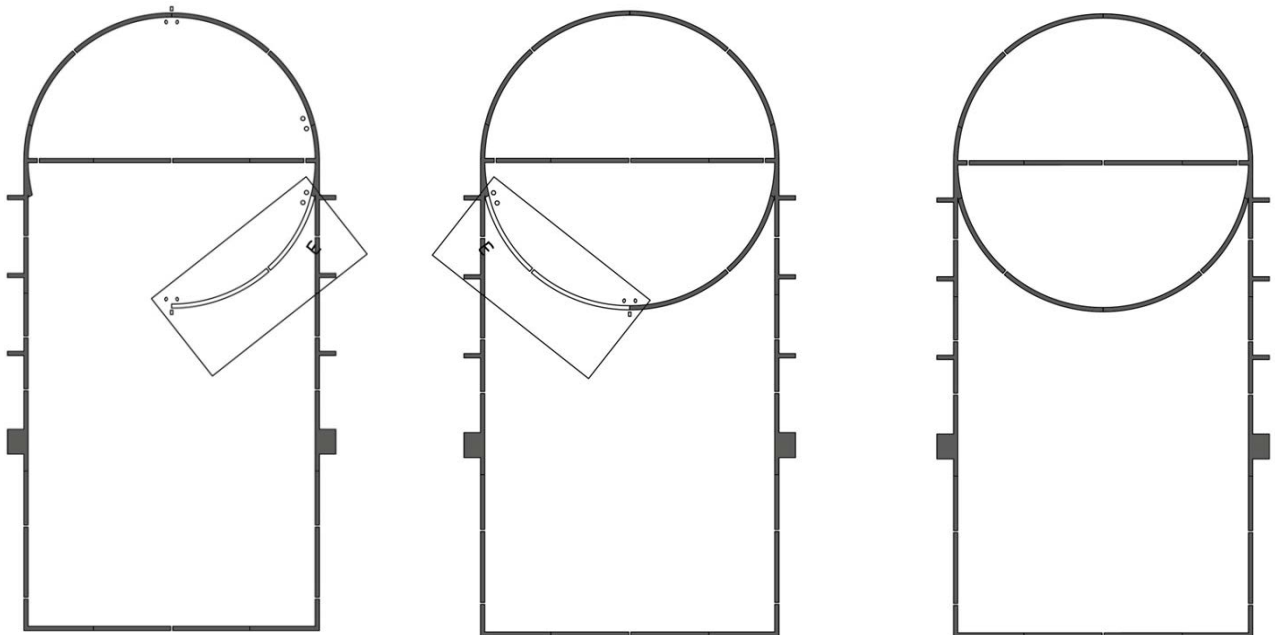

5. Allow to completely dry for at least 24 hours before use.

Any questions? We're here to help – call us at (800) 681-0684!

THIS INFORMATION IS COPYRIGHT MATERIAL. ALL RIGHTS ARE RESERVED.