

Hydraulic power unit

CytroBox



- ▶ Component series 1X
- ▶ Maximum operating pressure 315 bar
- ▶ Maximum flow 160 l/min

Features

- ▶ Integrated drive controller
- ▶ Power up to 30 kW with identical frame size and interfaces
- ▶ Servo drive
- ▶ Reduced hydraulic fluid volume due to degassing-optimized tank
- ▶ Optional set-up of different control systems

Contents

Features	1
Ordering code	2 ... 5
Circuit diagram	6
Technical data	7, 8
Electrical connections	9, 10
Interfaces	11, 12
Characteristic curves	13 ... 16
Dimensions	17
Return flow filter (optional)	18
Accessories	19
Project planning information	20
Further information	20

Ordering code

01	02	03	04	05	06	07	08	09	10	11	12	13	
CYTROBOX	-	/	A	A	A	/	/	00	0	/	0	/	*

01	Hydraulic power unit	CYTROBOX
----	----------------------	----------

Version

02	Standard	N
	Functionality extension	F

Oscillating volume

03	Maximum 50 liters	A
----	-------------------	---

Control cabinet

04	Position "top"	A
----	----------------	---

Cooling

05	Motor and hydraulic system water-cooled; control cabinet air-cooled	A
----	---	---

Motor-pump group (drive 1)

06	A10FZO010/MS2N07-E0BNL	AA
	A10FZO016/MS2N07-E0BNL	BA
	A10FZO032/MS2N10-F0BHL	CB
	A10FZO045/MS2N10-F0BHL	DB
	A10FZO063/MS2N10-F0BHL	EB

Converter (drive 1)

07	HCS03-0070	A
	HCS03-0100	B
	HCS03-0150	C

Motor-pump group (drive 2)

08	Without	00
----	---------	----

Converter (drive 2)

09	Without	0
----	---------	---

Oil cooling

10	Without (standard)	0
	Cooling power 4 kW	A
	Cooling power 10 kW	B

Oil treatment

11	Pressure filter (standard)	A
	Pressure filter and return flow filter	B

Sensor technology

12	Standard sensor package	AAA
	For more sensor packages, see selection table on page 5	e.g. AAE
13	Further details in the plain text	*

Ordering code

CytroBox selection table

Motor-pump group in cm ³	Converter in A (max)	Cooling	Sensor package	Denomination	Material number
10	70	without	AAA	CYTROBOX-N/AAA/AAA/000/0A/AAA	R901600033
			AAB	CYTROBOX-N/AAA/AAA/000/0A/AAB	R901600001
			ABG	CYTROBOX-N/AAA/AAA/000/0A/ABG	R901600068
		4 kW	AAA	CYTROBOX-N/AAA/AAA/000/AA/AAA	R901600041
			AAB	CYTROBOX-N/AAA/AAA/000/AA/AAB	R901600003
			ABG	CYTROBOX-N/AAA/AAA/000/AA/ABG	R901600084
		10 kW	AAA	CYTROBOX-N/AAA/AAA/000/BA/AAA	R901600060
			AAB	CYTROBOX-N/AAA/AAA/000/BA/AAB	R901600092
			ABG	CYTROBOX-N/AAA/AAA/000/BA/ABG	R901600069
16	70	without	AAA	CYTROBOX-N/AAA/BAA/000/0A/AAA	R901600034
			AAB	CYTROBOX-N/AAA/BAA/000/0A/AAB	R901600005
			ABG	CYTROBOX-N/AAA/BAA/000/0A/ABG	R901600070
		4 kW	AAA	CYTROBOX-N/AAA/BAA/000/AA/AAA	R901600042
			AAB	CYTROBOX-N/AAA/BAA/000/AA/AAB	R901600007
			ABG	CYTROBOX-N/AAA/BAA/000/AA/ABG	R901600085
		10 kW	AAA	CYTROBOX-N/AAA/BAA/000/BA/AAA	R901600061
			AAB	CYTROBOX-N/AAA/BAA/000/BA/AAB	R901600093
			ABG	CYTROBOX-N/AAA/BAA/000/BA/ABG	R901600071
32	100	without	AAA	CYTROBOX-N/AAA/CBB/000/0A/AAA	R901600035
			AAB	CYTROBOX-N/AAA/CBB/000/0A/AAB	R901600009
			ABG	CYTROBOX-N/AAA/CBB/000/0A/ABG	R901600072
		4 kW	AAA	CYTROBOX-N/AAA/CBB/000/AA/AAA	R901600043
			AAB	CYTROBOX-N/AAA/CBB/000/AA/AAB	R901600011
			ABG	CYTROBOX-N/AAA/CBB/000/AA/ABG	R901600086
		10 kW	AAA	CYTROBOX-N/AAA/CBB/000/BA/AAA	R901600062
			AAB	CYTROBOX-N/AAA/CBB/000/BA/AAB	R901600094
			ABG	CYTROBOX-N/AAA/CBB/000/BA/ABG	R901600073
32	150	without	AAA	CYTROBOX-N/AAA/CBC/000/0A/AAA	R901600036
			AAB	CYTROBOX-N/AAA/CBC/000/0A/AAB	R901600013
			ABG	CYTROBOX-N/AAA/CBC/000/0A/ABG	R901600074
		4 kW	AAA	CYTROBOX-N/AAA/CBC/000/AA/AAA	R901600044
			AAB	CYTROBOX-N/AAA/CBC/000/AA/AAB	R901600015
			ABG	CYTROBOX-N/AAA/CBC/000/AA/ABG	R901600087
		10 kW	AAA	CYTROBOX-N/AAA/CBC/000/BA/AAA	R901600063
			AAB	CYTROBOX-N/AAA/CBC/000/BA/AAB	R901600095
			ABG	CYTROBOX-N/AAA/CBC/000/BA/ABG	R901600075

Ordering code

Motor-pump group in cm ³	Converter in A (max)	Cooling	Sensor package	Denomination	Material number
45	100	without	AAA	CYTROBOX-N/AAA/DBB/000/0A/AAA	R901600037
			AAB	CYTROBOX-N/AAA/DBB/000/0A/AAB	R901600017
			ABG	CYTROBOX-N/AAA/DBB/000/0A/ABG	R901600076
		4 kW	AAA	CYTROBOX-N/AAA/DBB/000/AA/AAA	R901600045
			AAB	CYTROBOX-N/AAA/DBB/000/AA/AAB	R901600019
			ABG	CYTROBOX-N/AAA/DBB/000/AA/ABG	R901600088
		10 kW	AAA	CYTROBOX-N/AAA/DBB/000/BA/AAA	R901600064
			AAB	CYTROBOX-N/AAA/DBB/000/BA/AAB	R901600096
			ABG	CYTROBOX-N/AAA/DBB/000/BA/ABG	R901600077
45	150	without	AAA	CYTROBOX-N/AAA/DBC/000/0A/AAA	R901600038
			AAB	CYTROBOX-N/AAA/DBC/000/0A/AAB	R901600021
			ABG	CYTROBOX-N/AAA/DBC/000/0A/ABG	R901600078
		4 kW	AAA	CYTROBOX-N/AAA/DBC/000/AA/AAA	R901600046
			AAB	CYTROBOX-N/AAA/DBC/000/AA/AAB	R901600023
			ABG	CYTROBOX-N/AAA/DBC/000/AA/ABG	R901600089
		10 kW	AAA	CYTROBOX-N/AAA/DBC/000/BA/AAA	R901600065
			AAB	CYTROBOX-N/AAA/DBC/000/BA/AAB	R901600097
			ABG	CYTROBOX-N/AAA/DBC/000/BA/ABG	R901600079
63	100	without	AAA	CYTROBOX-N/AAA/EBB/000/0A/AAA	R901600039
			AAB	CYTROBOX-N/AAA/EBB/000/0A/AAB	R901600025
			ABG	CYTROBOX-N/AAA/EBB/000/0A/ABG	R901600080
		4 kW	AAA	CYTROBOX-N/AAA/EBB/000/AA/AAA	R901600047
			AAB	CYTROBOX-N/AAA/EBB/000/AA/AAB	R901600027
			ABG	CYTROBOX-N/AAA/EBB/000/AA/ABG	R901600090
		10 kW	AAA	CYTROBOX-N/AAA/EBB/000/BA/AAA	R901600066
			AAB	CYTROBOX-N/AAA/EBB/000/BA/AAB	R901600098
			ABG	CYTROBOX-N/AAA/EBB/000/BA/ABG	R901600081
63	150	without	AAA	CYTROBOX-N/AAA/EBC/000/0A/AAA	R901600040
			AAB	CYTROBOX-N/AAA/EBC/000/0A/AAB	R901600029
			ABG	CYTROBOX-N/AAA/EBC/000/0A/ABG	R901600082
		4 kW	AAA	CYTROBOX-N/AAA/EBC/000/AA/AAA	R901600048
			AAB	CYTROBOX-N/AAA/EBC/000/AA/AAB	R901600031
			ABG	CYTROBOX-N/AAA/EBC/000/AA/ABG	R901600091
		10 kW	AAA	CYTROBOX-N/AAA/EBC/000/BA/AAA	R901600067
			AAB	CYTROBOX-N/AAA/EBC/000/BA/AAB	R901600099
			ABG	CYTROBOX-N/AAA/EBC/000/BA/ABG	R901600083

Ordering code

Sensor selection table

Type	Standard				Optional						
	Control pressure	Tank filling level	Tank temperature	Pressure filter contamination	Pump leakage flow	Pump leakage temperature	Water content in tank	Dissolved air share in tank	Dirt particles in tank	Oil pan leakage	
AAA	✓	✓	✓	✓	-	-	-	-	-	-	
AAB	✓	✓	✓	✓	✓	✓	-	-	-	-	
AAC	✓	✓	✓	✓	-	-	✓	-	-	-	
AAD	✓	✓	✓	✓	✓	✓	✓	-	-	-	
AAE	✓	✓	✓	✓	-	-	-	✓	-	-	
AAF	✓	✓	✓	✓	✓	✓	-	✓	-	-	
AAG	✓	✓	✓	✓	-	-	✓	✓	-	-	
AAH	✓	✓	✓	✓	✓	✓	✓	✓	-	-	
AAI	✓	✓	✓	✓	-	-	-	-	✓	-	
AAJ	✓	✓	✓	✓	✓	✓	-	-	✓	-	
AAK	✓	✓	✓	✓	-	-	✓	-	✓	-	
AAL	✓	✓	✓	✓	✓	✓	✓	-	✓	-	
AAM	✓	✓	✓	✓	-	-	-	✓	✓	-	
AAN	✓	✓	✓	✓	✓	✓	-	✓	✓	-	
AAO	✓	✓	✓	✓	-	-	✓	✓	✓	-	
AAP	✓	✓	✓	✓	✓	✓	✓	✓	✓	-	
AAR	✓	✓	✓	✓	-	-	-	-	-	✓	
AAS	✓	✓	✓	✓	✓	✓	-	-	-	✓	
AAT	✓	✓	✓	✓	-	-	✓	-	-	✓	
AAU	✓	✓	✓	✓	✓	✓	✓	-	-	✓	
AAV	✓	✓	✓	✓	-	-	-	✓	-	✓	
AAW	✓	✓	✓	✓	✓	✓	-	✓	-	✓	
AAX	✓	✓	✓	✓	-	-	✓	✓	-	✓	
AAZ	✓	✓	✓	✓	✓	✓	✓	✓	-	✓	
ABA	✓	✓	✓	✓	✓	✓	-	-	✓	✓	
ABB	✓	✓	✓	✓	-	-	✓	-	✓	✓	
ABC	✓	✓	✓	✓	✓	✓	✓	-	✓	✓	
ABD	✓	✓	✓	✓	-	-	-	✓	✓	✓	
ABE	✓	✓	✓	✓	✓	✓	-	✓	✓	✓	
ABF	✓	✓	✓	✓	-	-	✓	✓	✓	✓	
ABG	✓	✓	✓	✓	✓	✓	✓	✓	✓	✓	



Notice:

The sensors are connected to the drive controllers via IO link. Current data and limit values can be read and set via the Multi-Ethernet interface.

Circuit diagram: hydraulic

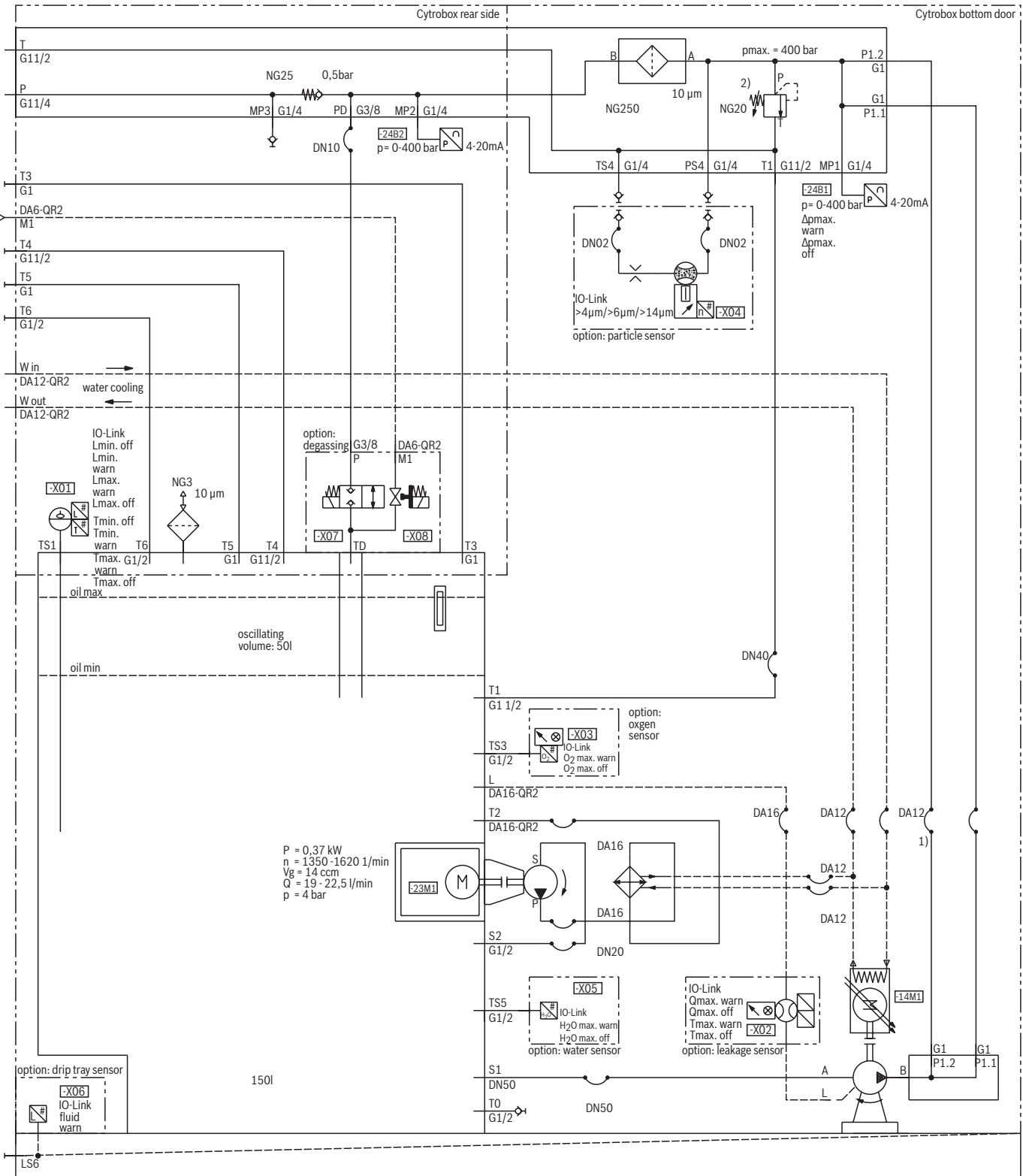

Technical data

(For applications outside these values, please consult us!)

General		
Installation position		Vertical
Line connections	▶ Pressure port	G1 1/4
	▶ Return flow	G1 1/2
Place of installation		Industrial building; stationary application
Ambient temperature range (during operation)	°C	+10 ... +40
Weight (depending on configuration level) without oil	kg	500 ... 550 depending on the equipment
Corrosion	▶ Tank	Plastic (PP)
Protection class	▶ Steel components	Galvanized, painted, powder-coated
	▶ Base	Polymer concrete

Hydraulic		
Maximum operating pressure	bar	315 (see characteristic curves)
Maximum flow	l/min	160 (see characteristic curves)
Maximum oscillating volume	l	50
Maximum tank capacity	l	150
Maximum temperature range hydraulic fluid	°C	+5 ... +70
Hydraulic fluids		Mineral oil HLP according to DIN 51524
Maximum admissible degree of contamination of the hydraulic fluid, cleanliness class according to ISO 4406 (c)		class 20/18/15 ¹⁾
Pressure filter ²⁾	▶ Filter rating	μm 10
Filling level monitoring	▶ Early warning	adjustable by means of parameter
	▶ Shut-off	adjustable by means of parameter
Temperature monitoring (hydraulic fluid)	▶ Early warning	adjustable by means of parameter
	▶ Shut-off	adjustable by means of parameter
Pump	▶ Minimum flow	l/min 0
	▶ Hydraulic fluid viscosity range (see data sheet 91485)	mm ² /s ≤ 1000 during cold start 1000 ... 400 warm-up phase 400 ... 16 continuous operation

¹⁾ The cleanliness classes specified for the components must be adhered to in hydraulic systems. Effective filtration prevents faults and simultaneously increases the life cycle of the components. For the selection of the filters, see www.boschrexroth.com/filter

²⁾ Directly mounted at the block



Important notice on hydraulic fluids:

For further information and data on the use of other hydraulic fluids, please contact us.

Technical data

(For applications outside these values, please consult us!)

Electric		
Voltage (according to IEC 60038)	V	400 ... 500 AC (+10% / -15%)
Frequency	Hz	50/60
Protection class according to DIN EN 60529		IP54
Maximum pre-fuse	▶ HCS03 - 0070	A 50
protective motor switch (on the customer side)	▶ HCS03 - 0100	A 80
	▶ HCS03 - 0150	A 125

Cooling water supply ³⁾		
Flow	l/min	20
Inlet temperature	°C	15 ... 25
Connections		Quick-release coupling push-in Ø12 mm
Maximum glycol share	%	30
Maximum cooling water pressure	bar	< 10

Plate heat exchanger		
Thermal output (for hydraulic fluid and motor)	kW	4; 10
Inlet oil temperature	°C	50
Outlet oil temperature	°C	43
Inlet water temperature	°C	20
Outlet temperature	°C	25

³⁾ In addition, the R911347582 project planning instructions for IndraDyn S must be observed. Maximum particle size ≤ 100 µm

 **Notice:**

- ▶ A cooling water supply must always be connected, the oil temperature can be set by means of parameters.
- ▶ The control cabinet is air-cooled and the electric motor is water-cooled. The hydraulic fluid is cooled by a circulation circuit with a plate heat exchanger.

Electrical connections: Voltage supply, data interfaces

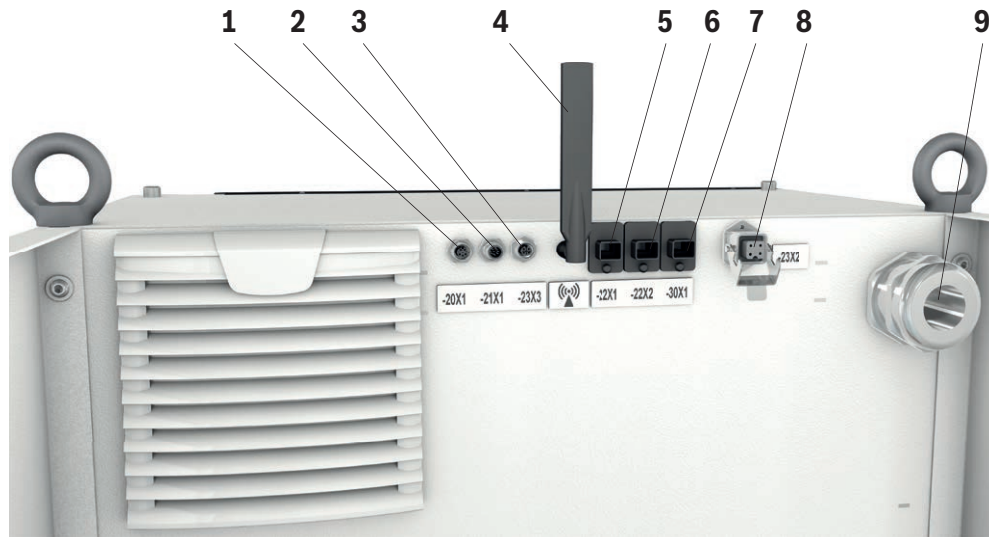

- 1 20X1: Digital input and output signals
- 2 21X1: Safe Torque OFF (STO)
- 3 23X3: Water valve control (optional)
- 4 Mobile communications antenna
- 5 22X1: Multi-Ethernet control communication (network output)
- 6 22X1: Multi-Ethernet control communication (network input)
- 7 30X1: CytroConnect
- 8 23X2: Cooling unit control (optional)
- 9 Cable bushing for power supply



Notice:

For further information, see project planning description R911338961.

20X1 (position 1), digital inputs and outputs

 (Mating connector) M12x1; 8-pole A-coded	Pin	Function	Input DI/output DO
		1	Release
	2	Reset	DI
	3	GND . Ext.	DI
	4	Filter alarm	DO
	5	Oil level alarm	DO
	6	Temperature alarm	DO
	7	Ready for operation, no error	DO
	8	In operation	DO

Inputs: 24 VDC (high ≥ 11 V ; low ≤ 5 V)
 Outputs: max. current 500 mA; total of all currents max. 2000 mA

Electrical connections: Voltage supply**21X1 (position 2), safety technology Safe Torque OFF (STO)**

(Connector)

M 12x1; 8-pole
A - coded

Pin	Function
1	Input channel 2
2	0 V power supply
3	Input channel 1
4	+24 V power supply $\pm 20\%/0.7$ A
5	Output channel 2
6	Output channel 1
7	not used
8	not used

For further information on connection possibilities see R911332633

RJ45 (IP67)	Position	Port	Function
	5	22X1	Multi-Ethernet Control communication
	6	22X2	
	7	30X1	Engineering port

Notice:

For RJ45 ports, only use suitable connectors (push-pull) in compliance with IP67, e.g.

R901469479 CONNECTOR IE-PS-V04P-RJ45-FH

R901471844 NETWORK CABLE RJ45/IP47-RJ45 5M

Mains connection voltage in VAC	Power rating	Maximum current in A	PIN	Terminal	Cable cross-section in mm ²
400 ... 500	70	63	L1	2	16 ... 25
			L2	4	
			L3	6	
			GNYE	PE	16
	100	100	L1	2	35 ... 50
			L2	4	
			L3	6	
			GNYE	PE	25
	150	125	L1	2	50 ... 70
			L2	4	
			L3	6	
			GNYE	PE	25

Interfaces

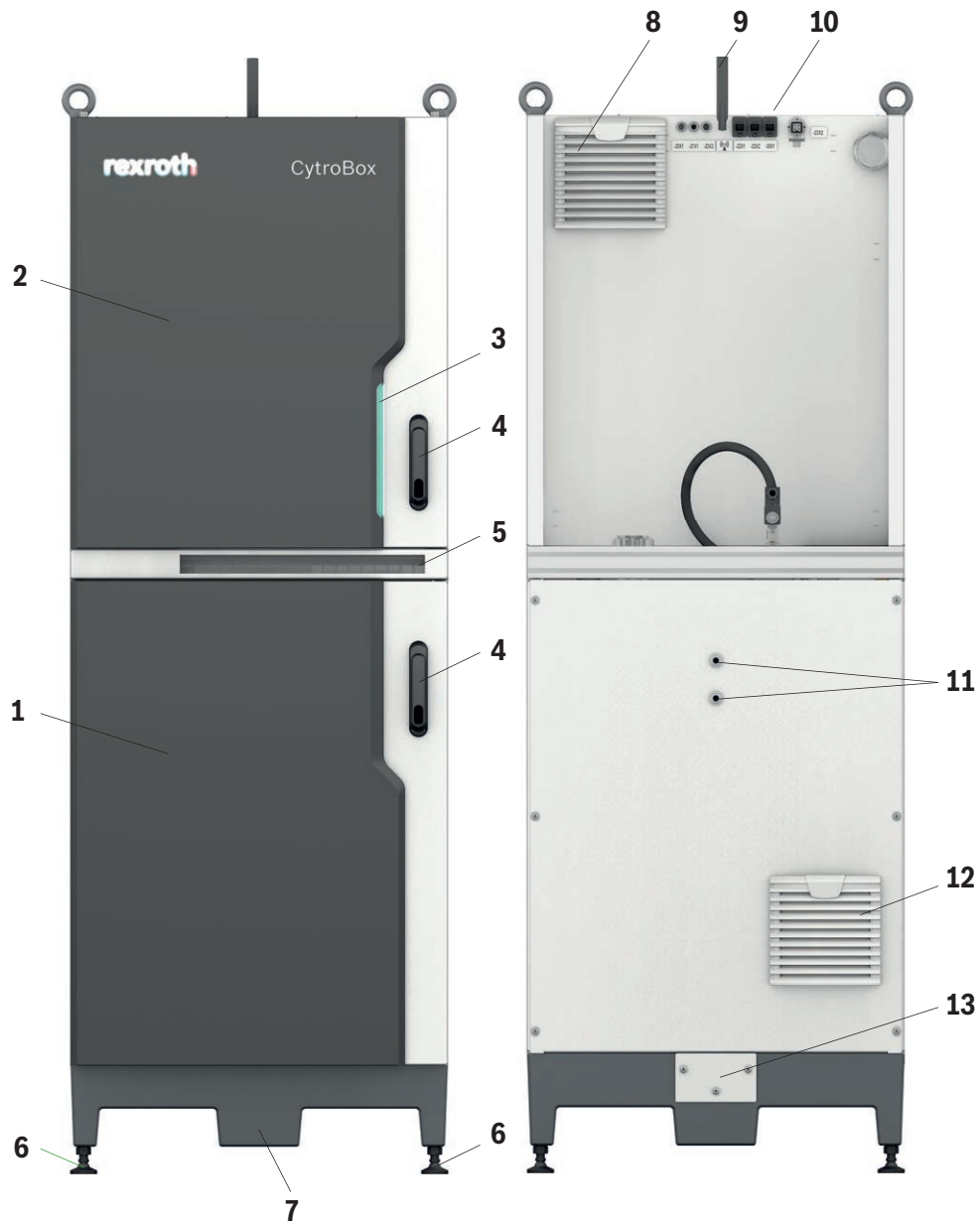

- 1 Hydraulic cabinet
- 2 Electrical cabinet
- 3 LED status display
- 4 Door opener
- 5 Air inlet at the electrical cabinet
- 6 Adjustable machine feet
- 7 Foundation made of polymer concrete

- 8 Air outlet at the electrical cabinet
- 9 Mobile antenna
- 10 Electrical interfaces
- 11 Cooling water connections (push-in, Ø12 mm)
- 12 Air inlet at the hydraulic cabinet
- 13 Drip pan discharge plate

Interfaces

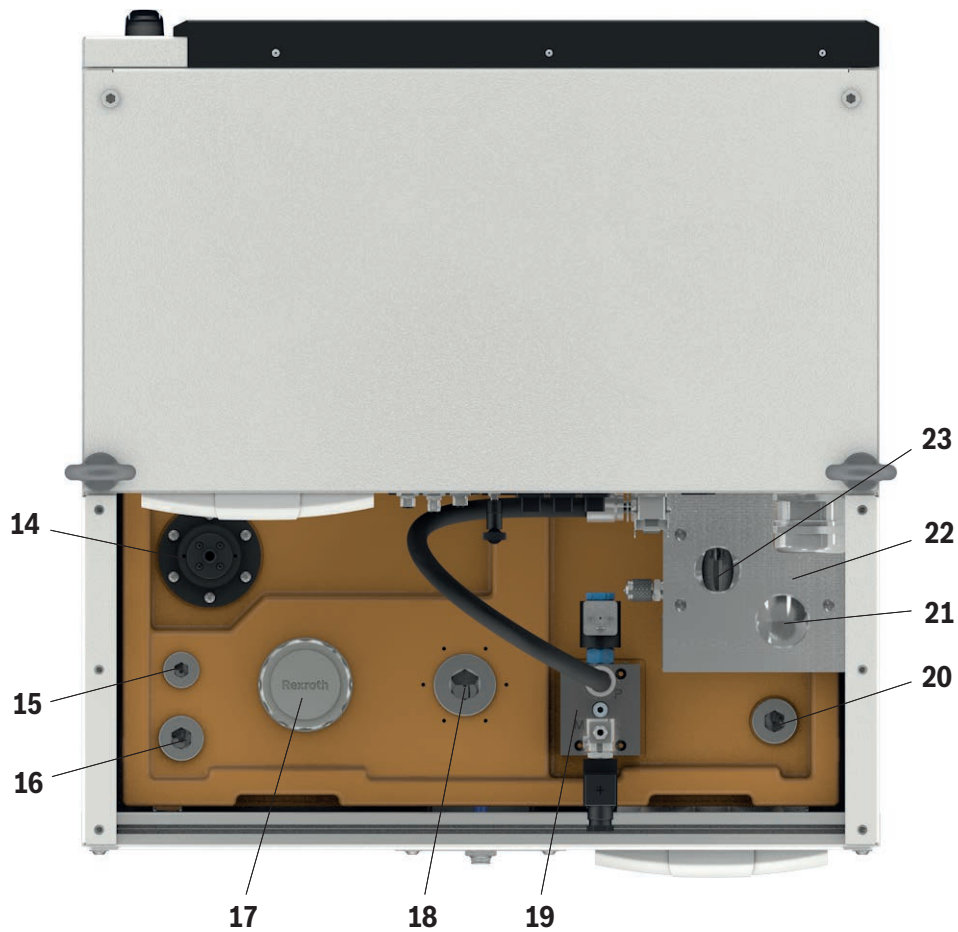

- 14 Level and temperature sensor
- 15 Tank spare port (G3/4)
- 16 Tank spare port (G1)
- 17 Breathing filter
- 18 Tank spare port (G1 1/2)
- 19 Degassing and irrigation module
- 20 Tank spare port (G3/4)
- 21 Return flow port T (G1)
- 22 Connection block; optional adapter for modular IH20 plate systems
- 23 Pressure port P (G1 1/4)

Characteristic curves

Design "AAA" (A10FZO010-MS2N07-E0BNL-HCS03.1E-W0070)

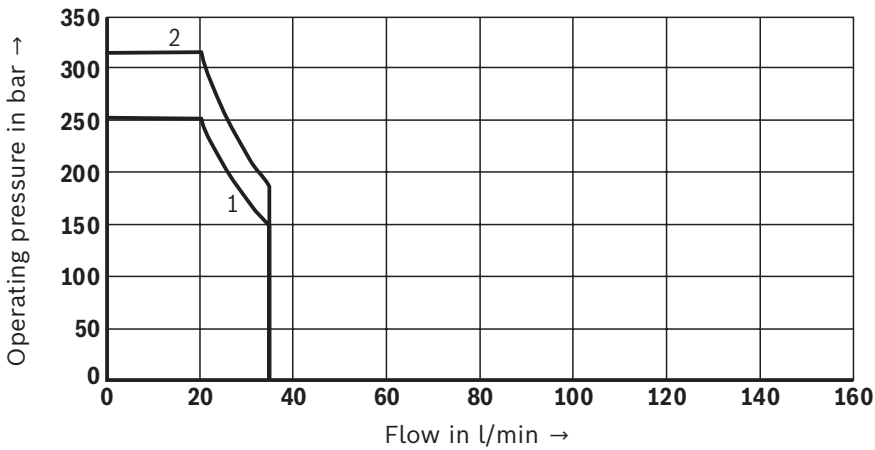

Continuous characteristic curve at

- 1 40 °C ambient temperature
- 2 30 °C ambient temperature

Design "BAA" (A10FZO016-MS2N07-E0BNL-HCS03.1E-W0070)

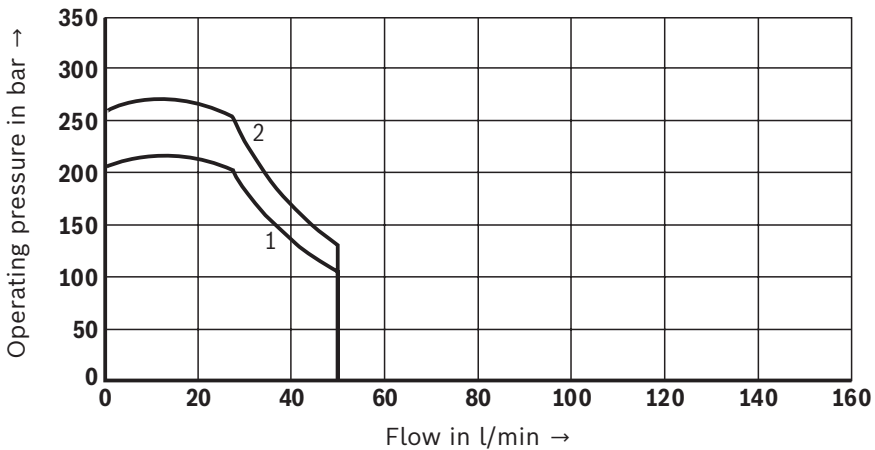

Continuous characteristic curve at

- 1 40 °C ambient temperature
- 2 30 °C ambient temperature

Version "CBB" (A10FZO032-MS2N10-F0BHL-HCS03.1E-W0100)

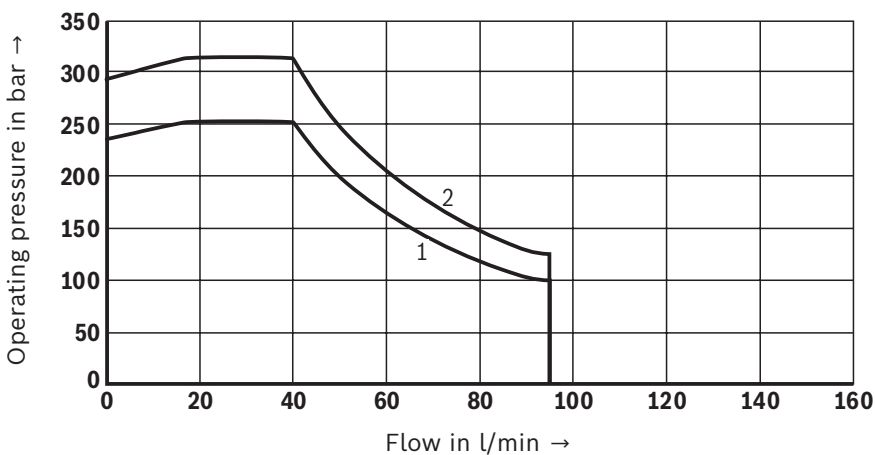

Continuous characteristic curve at

- 1 40 °C ambient temperature
- 2 30 °C ambient temperature

Notice:

At ambient temperatures > 30 °C, the power characteristic curve is reduced by 2% per Kelvin temperature increase. Maximum ambient temperature 40 °C.

Characteristic curves

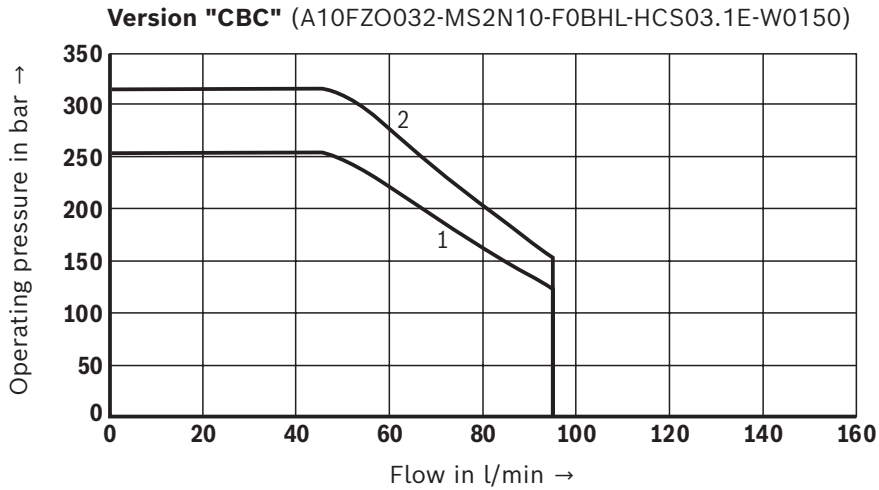

Continuous characteristic curve at

- 1 40 °C ambient temperature
- 2 30 °C ambient temperature

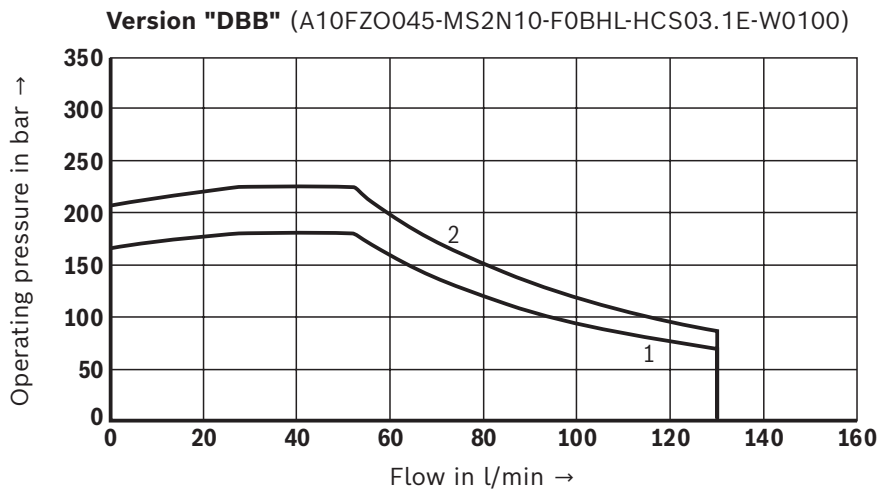

Continuous characteristic curve at

- 1 40 °C ambient temperature
- 2 30 °C ambient temperature

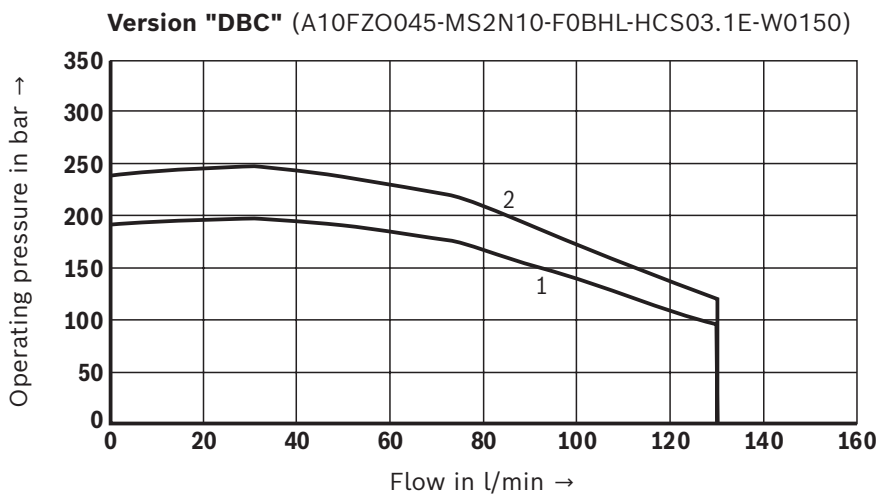

Continuous characteristic curve at

- 1 40 °C ambient temperature
- 2 30 °C ambient temperature

Notice:

At ambient temperatures > 30 °C, the power characteristic curve is reduced by 2% per Kelvin temperature increase. Maximum ambient temperature 40 °C.

Characteristic curves

Version "EBB" (A10FZO063-MS2N10-F0BHL-HCS03.1E-W0100)

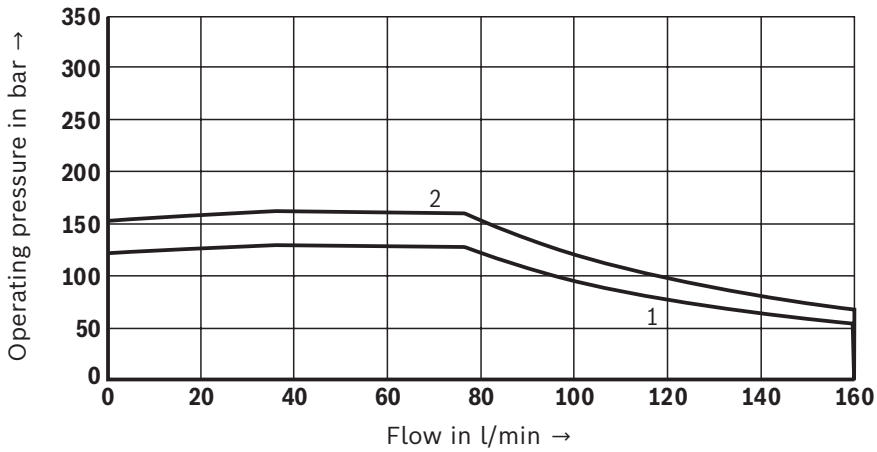

Continuous characteristic curve at

- 1 40 °C ambient temperature
- 2 30 °C ambient temperature

Version "EBC" (A10FZO063-MS2N10-F0BHL-HCS03.1E-W0150)

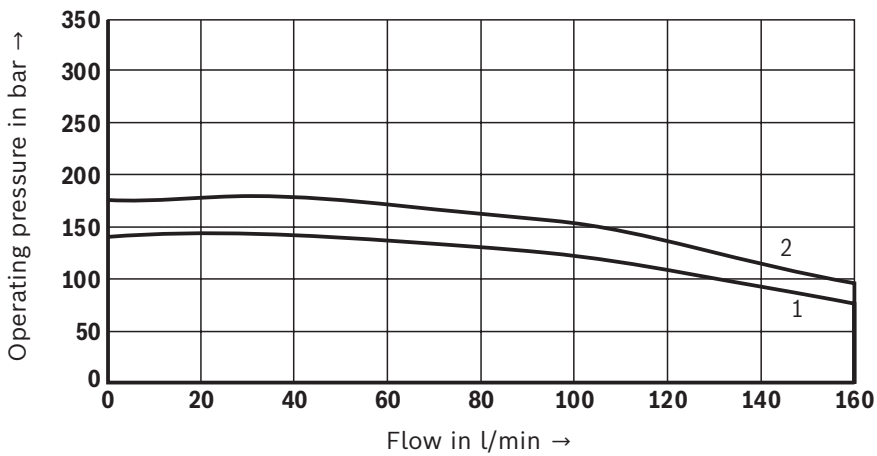

Continuous characteristic curve at

- 1 40 °C ambient temperature
- 2 30 °C ambient temperature

 **Notice:**

At ambient temperatures > 30 °C, the power characteristic curve is reduced by 2% per Kelvin temperature increase. Maximum ambient temperature 40 °C.

Characteristic curves: Cooler

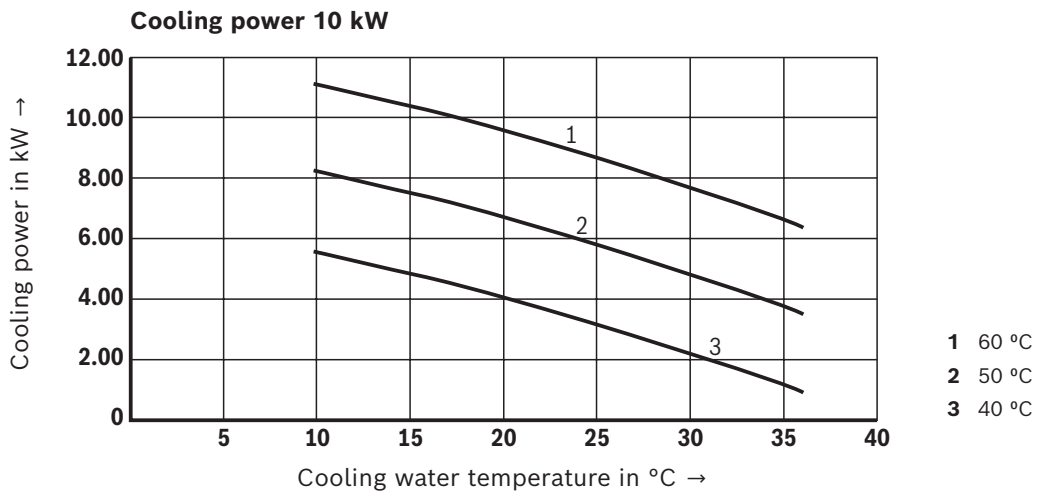
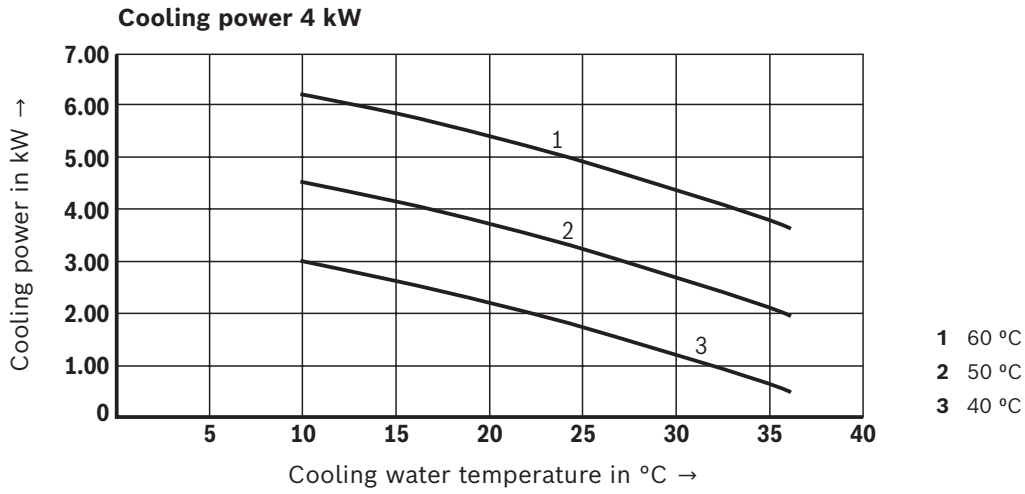

Dimensions
(dimensions in mm)

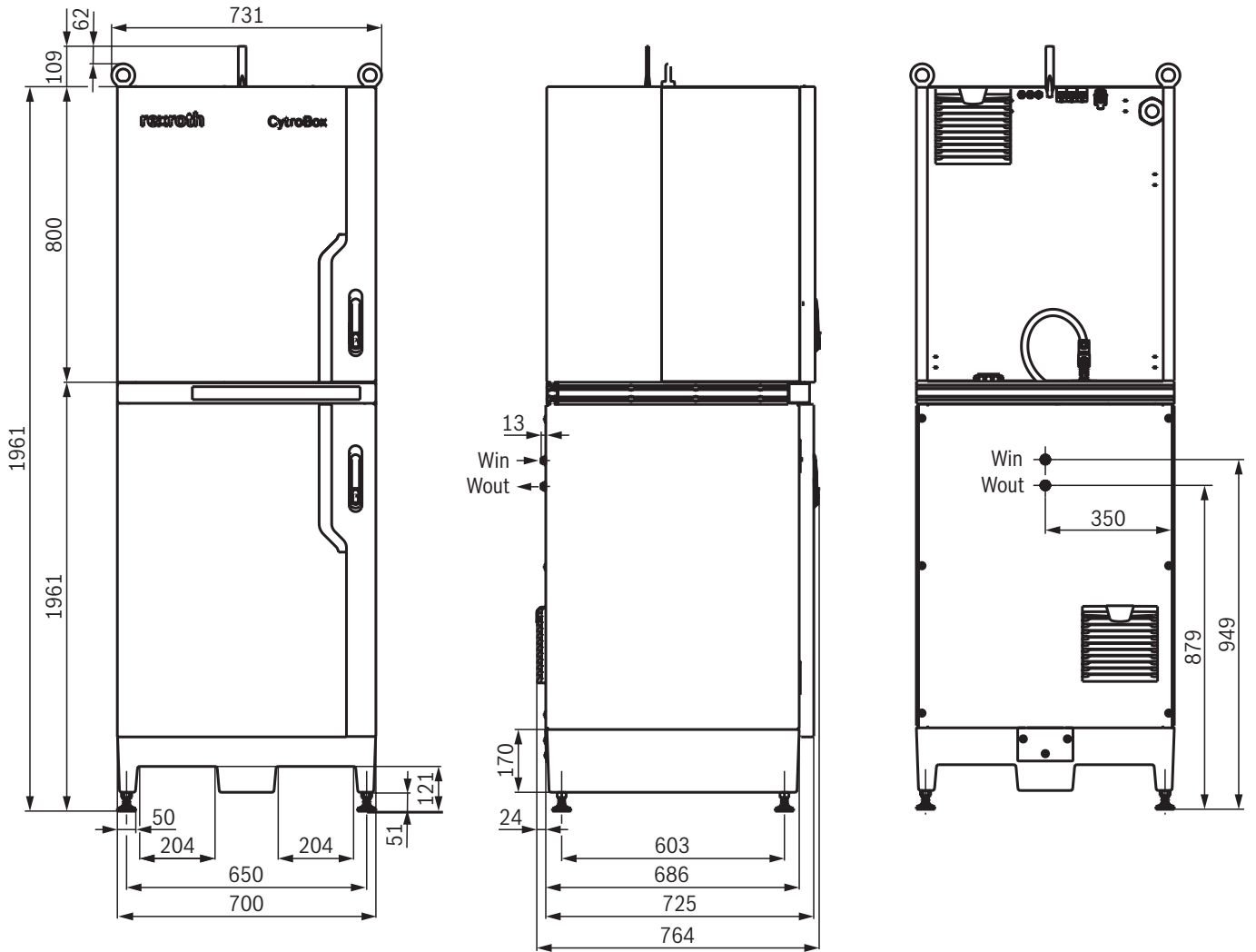

Return flow filter (optional)

For the CytroBox an optional return flow filter is available as an assembly.

This is mounted on the back of the tank port G1 1/2 and contains a pressure sensor type HM20 for back pressure measurement, see page 19.

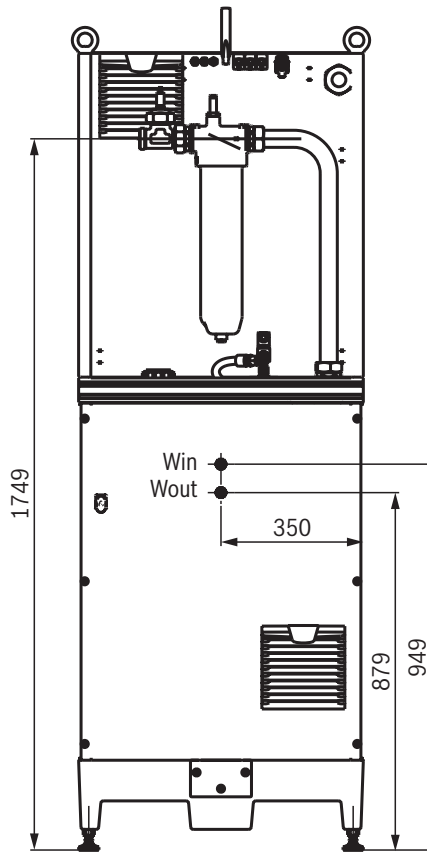

Accessories

► Electric

20X1, analog / digital input signals

		Comment	scope of delivery
R913002119	CONDUCTOR PLUG 8P 7000-17081-2910500	Connection plug, straight, shielded, 8-pole M12, with free PUR line end, Length: 5 m (8 x 0.25 mm ² /Ø7.0 mm) 24 VAC/DC, max. 1.5 A; IP67	1
R913002641	CONDUCTOR PLUG 8P 7000-17081-2911000	Connection plug, straight, shielded, 8-pole M12, with free PUR line end, Length: 10 m (8 x 0.25 mm ² /Ø7.0 mm) 24 VAC/DC, max. 1.5 A; IP67	1

21X1, Safe Torque OFF (STO)

		Comment	scope of delivery
R913002121	PLUG-IN CONNECTOR 8P 7000-17121-2910500	Socket, straight, shielded, 8-pole M12, with free PUR line end, Length: 5 m (8 x 0.25 mm ² /Ø7.0 mm) 24 VAC/DC, max. 1.5 A; IP67	1
R901467712	PLUG-IN CONNECTOR 7000-17041-3771000	Bush straight with cable support sleeve 8-pole M12, with free PUR line end, Length: 10 m (8 x 0.34 mm ² /Ø6.2 mm) 30 VAC/DC, max. 2.0 A; IP65 and IP67 in plugged and screwed condition	1

21X1 / 22X2 / 30X1, Multi-Ethernet interface / CytroConnect ¹⁾

		Comment	scope of delivery
R901469479	CONNECTION PLUG IE-PS-V04P-RJ45-FH	Connector without cable	1
R901471844	NETWORK CABLE RJ45/IP67-RJ45 5M	Length: 5 m Certificate: CAT 6 A / RoHS	1
R901471845	NETWORK CABLE RJ45/IP67-RJ45 10M	Length: 10 m Certificate: CAT 6 A / RoHS	1
R901492613	NETWORK CABLE RJ45/IP67-RJ45 20M	Length: 20 m Certificate: CAT 6 A / RoHS	1

► Mechanical

		Comment	scope of delivery
R901500465	COUPLING SOCKET CEJN567-G1/2-020-105&	Counterpart filling coupling	1
1823391944	FITTING QR2-S-RVA-DA12-DA12	Pneumatic angle for cooling water connection	2
R901527423	INLINE FILTER CB ASSEMBLY RETURN FLOW FILTER	Optional assembly return flow filter incl. HM20 pressure sensor	1

¹⁾ We recommend using the Multi-Ethernet cable provided by Rexroth (protection class IP67).

Project planning information

- ▶ Design
Sytronix Size - SvP 7020. Only selected converter and motor-pump combinations can be realized.
- ▶ Connectivity
The default 4G interface enables connection of the CytroBox to the CytroConnect Service. This way, additional Cloud-based functions are available. For detailed information, see www.Cytroconnect.com

Further information

- | | |
|---|--|
| ▶ Hydraulic fluids on mineral oil basis | Data sheet 90220 |
| ▶ Environmentally compatible hydraulic fluids | Data sheet 90221 |
| ▶ Rexroth IndraDrive | R911332633 |
| ▶ IndraDrive control parts | R911338961 |
| ▶ IndraDyn S | R911347582 |
| ▶ Selection of the filters | www.boschrexroth.com/filter |
| ▶ Information on available spare parts | www.boschrexroth.com/spc |

Bosch Rexroth AG
Industrial Hydraulics
Zum Eisengießer 1
97816 Lohr am Main, Germany
Phone +49 (0) 93 52/40 30 20
my.support@boschrexroth.de
www.boschrexroth.de

© All rights reserved to Bosch Rexroth AG, also regarding any disposal, exploitation, reproduction, editing, distribution, as well as in the event of applications for industrial property rights.
The data specified above only serve to describe the product. No statements concerning a certain condition or suitability for a certain application can be derived from our information. The information given does not release the user from the obligation of own judgment and verification.
It must be remembered that our products are subject to a natural process of wear and aging.