

DESIGNED TO PERFORM IN VERY CONFINED SPACES.

FBCS14N-FBCS18N

3,000 - 4,000 LB CAPACITY
STAND-UP COUNTERBALANCED FORKLIFT

1. Flexible

Maneuverable Design

The stand-up counterbalance's space-saving design allows the truck to stack and retrieve goods efficiently in significantly narrower aisles than other counterbalanced trucks and at high lift heights, allowing you to maximize space.

Personalized Solutions

Designed with standard cushion tires and a variety of mast and load handling options, the FBCS14N-FBCS18N series is ideal for dock-to-stock applications, shuttling goods or moving large loads in confined spaces.

2. Smart

AC Control System

The PM-1000 Alternating Current (AC) hydraulic system provides competitive lift speeds with precise fork movement, resulting in increased productivity for your application.

Performance Customization

Three programmed performance modes and a number of performance parameters can be adjusted from the display to suit a wide range of operator and application requirements or preferences.

3. Efficient

In Control

The intuitive, multi-function control handle is centrally positioned for easy access to truck functions and offers simultaneous control of drive, lift/lower and auxiliary hydraulic functions.

Electric Power Steering

Electric power steering provides improved energy efficiency, operator comfort and serviceability over traditional hydrostatic power steering.

4. Ergonomic

Enhanced Comfort

The stand-up counterbalance features a suspended anti-fatigue floor board that can adjust to the operator's weight. The adjustable armrest and backrest fit around the operator, providing comfort during the entire shift.

4" HD full color display

The easy-to-read control panel displays the information the operator needs to perform daily tasks, such as load weight, travel speed, 360° steer direction, event message indicator and more.



CHARACTERISTICS			FBCS14N		FBCS16N		FBCS18N	
1	Capacity at rated load center	lb kg	3,000	1,364	3,500	1,591	4,000	1,818
2	Capacity load center - distance from fork face	in mm	24	600	24	600	24	600
3	Power voltage	V	36 AC electric		36 AC electric		36 AC electric	
4	Tire type, drive / steer		solid rubber / poly		solid rubber / poly		solid rubber / poly	
5	Wheels (x=driven)		2x / 2		2x / 2		2x / 2	
DIMENSIONS								
6	Maximum fork height lift with standard triplex mast	in mm	188	4,775	188	4,775	188	4,775
7	Free fork height lift with standard triplex mast	in mm	35	889	35	889	35	889
8	Fork width	in mm	3.9	100	3.9	100	3.9	100
9	Fork thickness	in mm	1.4	35	1.4	35	1.6	40
10	Fork spacing – out-to-out minimum	in mm	9.5	240	9.5	240	9.5	240
11	Fork spacing – out-to-out maximum	in mm	36.5	920	36.5	920	36.5	920
12	Tilt angle, forward / backward	deg	3 / 5		3 / 5		3 / 5	
13	Mast width	in mm	22	570	22	570	22	570
14	Length to fork face	in mm	63.0	1,601	65.0	1,652	70.0	1,778
15	Overall chassis width	in mm	41	1,041	41	1,041	41.0	1,041
16	Overall lowered height (mast)	in mm	82.9	2,105	82.9	2,105	82.9	2,105
17	Overall lowered height to top of overhead guard	in mm	88.0	2,240	88.0	2,240	88.0	2,240
18	Overall height with extended mast	in mm	236.6	6,009	236.6	6,009	236.6	6,009
19	Step height	in mm	9.4	240	9.4	240	9.4	240
20	Battery roller height	in mm	7.0	178	7.0	178	7.0	178
21	Load moment constant ^[2]	in mm	12.2	310	12.2	310	12.2	315
22	Minimum outside turning radius ^[3]	in mm	50.8	1,291	52.8	1,342	57.8	1,469
23	Minimum aisle – 90° stack – zero clearance ^[1]	in mm	turning radius + load moment constant + load length + aisle clearance					
PERFORMANCE								
24	Travel speed, loaded / empty	mph kph	8 / 8	12.9 / 12.9	8 / 8	12.9 / 12.9	8 / 8	12.9 / 12.9
25	Lift speed, loaded (triplex)	mph kph	83	0.42	83	0.42	83	0.42
26	Lift speed, empty (triplex)	fpm m/s	118	0.60	118	0.60	118	0.60
27	Lower speed, loaded (triplex)	fpm m/s	102	0.52	102	0.52	102	0.52
28	Lower speed, empty (triplex)	fpm m/s	98	0.50	98	0.50	98	0.50
29	Gradeability, loaded (maximum) at 1 mph / 1.6 km/h	%	15		15		15	
30	Gradeability, empty (maximum) at 1 mph / 1.6 km/h	%	15		15		15	
WEIGHT								
31	Truck weight – empty with minimum weight battery	lb kg	8,424	3,829	8,424	3,829	9,244	4,202
32	Battery weight (minimum)	lb kg	1,700	773	2,000	909	2,600	1,182
33	Battery weight (maximum)	lb kg	2,000	909	2,300	1,045	2,900	1,318
CHASSIS								
34	Chassis type, stand / sit		stand		stand		stand	
35	Wheelbase ^[4]	in mm	41.7	1,059	43.7	1,110	48.7	1,237
36	Ground clearance – center of wheelbase	in mm	4.0	102	4.0	102	4.0	102
37	Ground clearance – lowest point at mast	in mm	3.0	76	3.0	76	3.0	76
38	Tire size, drive	in	16 x 7 x 10.5		16 x 7 x 10.5		16 x 7 x 10.5	
39	Tire size, steer	in	10 x 5 x 6.5		10 x 5 x 6.5		10 x 5 x 6.5	
40	Brake type		electromagnetic disc		electromagnetic disc		electromagnetic disc	
ELECTRICAL								
41	Traction motor type		AC induction		AC induction		AC induction	
42	Traction motor output kW (60 minute rating)	HP kW	5.4 (x2)	4.0 (x2)	5.4 (x2)	4.0 (x2)	5.4 (x2)	4.0 (x2)
43	Pump motor type		AC induction		AC induction		AC induction	
44	Pump motor output kW (15% rating)	HP kW	17.4	13.0	17.4	13.0	17.4	13.0
45	Steer motor type		AC induction		AC induction		AC induction	
46	Steer motor output kW (60 minute rating)	HP kW	0.9	0.7	0.9	0.7	0.9	0.7
47	Battery maximum capacity – A/H (6 hour rating)	AH	1,240		1,240		1,240	
48	Battery compartment length (front - back)	in mm	14.25	362	16.25	413	21.25	540
49	Battery compartment width (side - side)	in mm	38.50	978	38.50	978	38.50	978
50	Battery compartment height	in mm	32.00	813	32.00	813	32.00	813

[1] Add load length and operator clearance.

[2] Add 2.25" (57.0 mm) for quad masts; add 2.50" (63.5 mm) for hang-on side shift / hang-on shift fork positioner options; Add 1.00" (25.4 mm) for integrated side shift

[3] Turning Radius: battery compartment 14.25" = 50.8" (1291mm); battery compartment 16.25" = 52.8" (1342mm); battery compartment 18.25" = 54.8" (1393mm); battery compartment 21.25" = 57.8" (1469mm);

[4] Wheelbase: battery compartment 14.25" = 41.7" (1059 mm); battery compartment 16.25" = 43.7" (1110 mm); battery compartment 18.25" = 45.7" (1161 mm); battery compartment 21.25" = 48.7" (1237 mm);

SAFETY STANDARDS

These trucks meet American National Standards Institute/Industrial Truck Standards Development Foundation, ANSI/ITSDF B56.1. UL-Classified by Underwriters Laboratories, Inc., as to fire and electric shock hazard only; Type E, EE (optional), Industrial Trucks. Users should be aware of, and adhere to, applicable codes and regulations regarding operator training, use, operation and maintenance of powered industrial trucks, including:

- ANSI/ITSDF B56.1.
- NFPA 505, fire safety standard for powered industrial trucks -type designations, areas of use, maintenance and operation.
- Occupational Safety and Health Administration (OSHA) regulations that may apply.

Specifications, equipment, technical data, photos and illustrations based on information at time of printing and subject to change without notice. Some products may be shown with optional equipment.

FBCS14N-FBCS18N

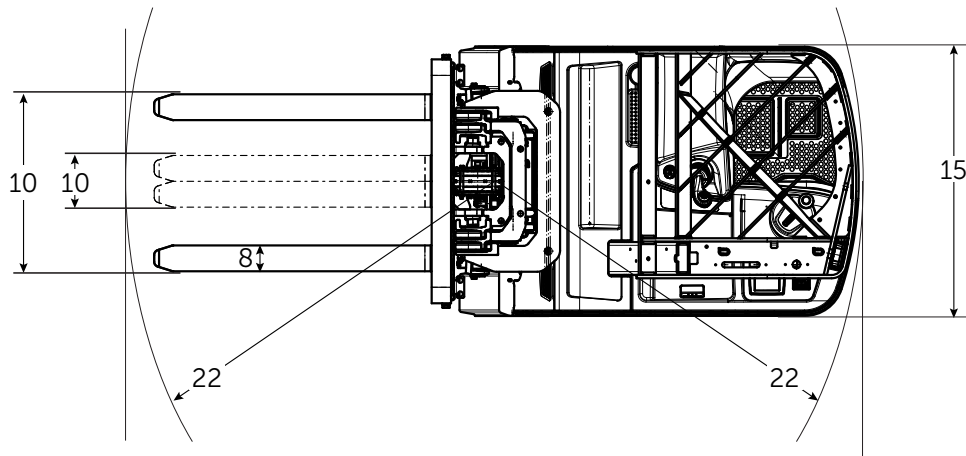
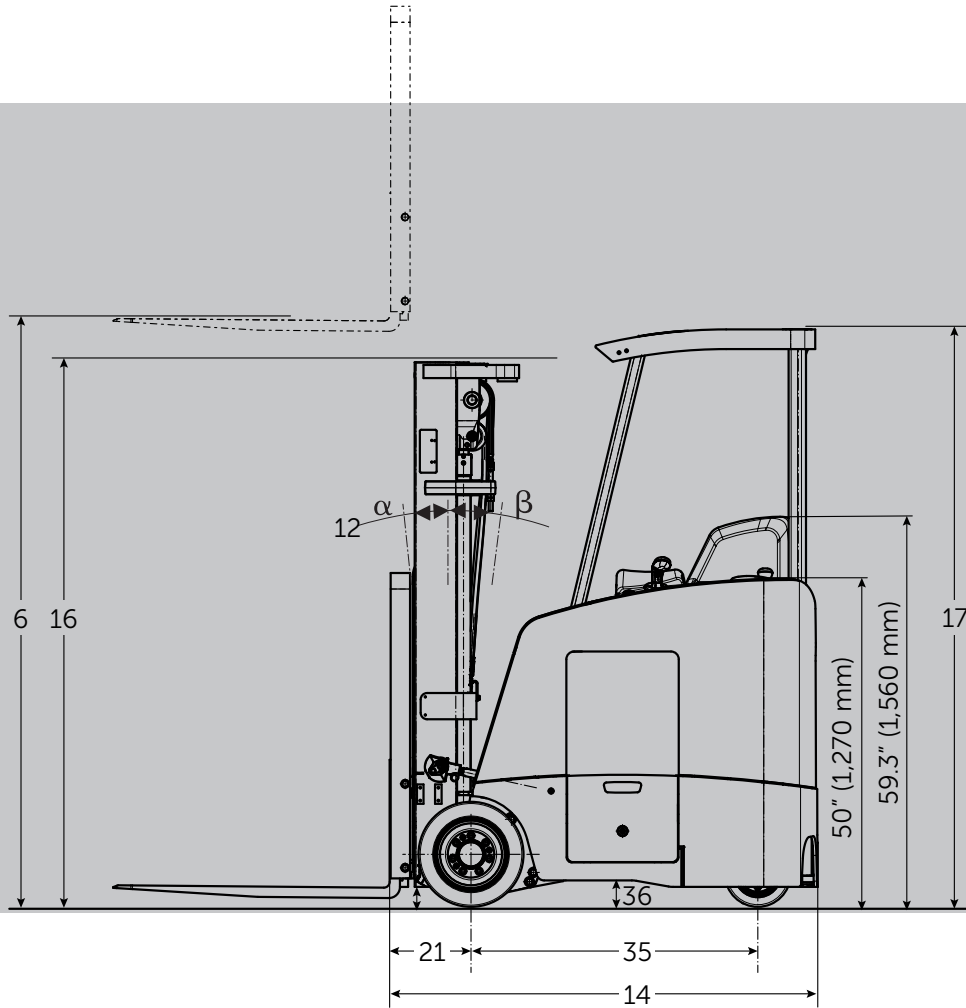

FBCS14N-FBCS18N

3,000 - 4,000 LB CAPACITY STAND-UP COUNTERBALANCED FORKLIFT

Flexible Operation

1. The One-Truck-Fits-All Solution

With optional quad masts along with various load handling options, the stand-up counterbalance series is as comfortable in a trailer as it is in the warehouse.

2. The Specific Solution

For applications requiring added protection from potential fire or electrical shock risks, these forklifts can be configured with an optional UL type EE rating.

3. Designed for Drive-in Racks

Designed with your application in mind, the FBCS14N-FBCS18N series comes standard with an overhead guard that works in drive-in-racks. A 50" backrest (lowered from the standard 60" extension) height plus the non-adjustable armrest and backrest padding are necessary for this application. This option can be used with the 83" and 91" overhead guard.

4. Freezer And Cooler Packages

To help keep the truck running smoothly in some of the harshest conditions, these packages include features and low-temperature fluids that can all be installed in the truck to fit the requirements of those applications.



Manufactured with superior quality and exceptional value, Mitsubishi forklift trucks are supported by an extensive dealer and field support network located throughout North and South America. Don't forget to ask your local Mitsubishi forklift truck dealer about details on factory retail programs, financing plans and additional options and dealer services like planned maintenance and operator training.