





High performance commercial refrigeration fan motor

- Dual voltage
- High efficiency
- High power factor
- Silent operation
- Drop-in replacement for Q frame or unit bearing motors
- RoHS and REACH compliant



Specifications	
Input voltage range	70-264V, 50-60Hz (all models)
Output power range	0-13W
Speed range	300-1800 RPM
Max. input power	20.5W
Max. input current	0.10A (@230V), 0.20A (@115V)
Power factor	Up to 0.95 depending on load and voltage
EMC protection	4000V (per EN61000-6-2)
Noise	SWL 37 dBA @ 1300 RPM (per ISO1680)
Insulation class	Class A (105°C)
Thermal protection	Electronic Protection. Locked rotor and automatic thermal
Refrigerant compatibility	HFC, CO2 and hydrocarbon (per IEC 60335-2-89 Annex BB)
ATEX (EX)	IEC 60079-7 Group 2, Category 3G
IP rating	IP67
Operating temp. range	-30°C to +50°C (-22°F to +122°F)
Storage temp. range	-40°C to +80°C (-40°F to +176°F)
Weight	0.54kg (1.2lb)
Approvals	    

Suitable Fans

	150mm (6") & 172mm (7")	200mm (8")				230mm (9")		254mm (10")		
		All Pitches	22°	28°	34°	40°	22°	28°	19°	22°
1300 RPM	✓	✓	✓	✓	?	✓	✓	✓	✓	?
1550 RPM	✓	✓	✓	✓	?	✓	?	?	?	✗
1800 RPM	✓	✓	✓	?	✗	?	✗	✗	✗	✗

 May not achieve rated RPM at all back pressures

WIRING DIAGRAM

For single speed operation



For three speed or reversible operation

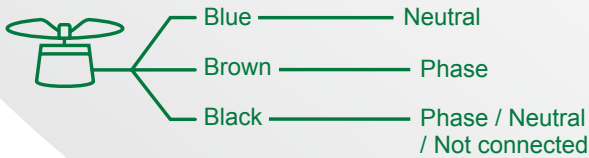

For variable speed operation

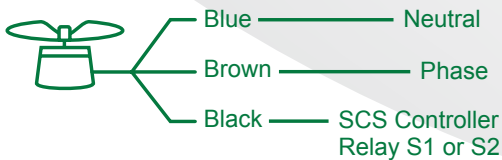

OEM OPTIONS

- Preprogrammed or factory/field programmable speeds
- Realtime continuously variable speed control over third mains wire (no extra cables required)
- Custom cable and plug options
- Metric, imperial, or custom hardware
- 3 speed, reversible, or timed-reverse options
- ATEX versions (Group2, Cat 3G)
- Food Grade rated housing option

MOUNTING OPTIONS

- Rear Mount: 4mm self-tapping screws in 3 hole or 4 hole configuration (screws not included: available on request)
- Foot Mount: 2 studs (optional)
- Basket Mount: 4 studs
- Fan Hub: 4 stud impeller mount to suit imperial or metric impellers
- Fan Mount: M4 screw with flat washer on female shaft thread or #10-32 UNF nyloc nut on male shaft thread.

Female shaft thread

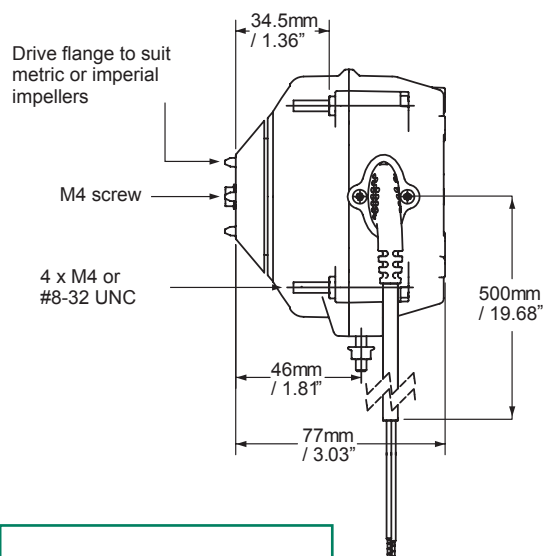

Male shaft thread

