





ATEX option

- Quiet - as low as 36.5 dBA
- Efficient - up to 70%
- Highly reliable - up to 10x more reliable
- Universal voltage (70-246V) - use one SKU anywhere
- 57:1 SKU reduction - reduces inventory and boosts profits



Specifications

Input voltage range	70-264V, 50-60Hz (all models)
Output power range	0-13W
Speed range	300-1800 RPM
Max. input power	20.5W
Max. input current	0.10A (@230V). 0.20A (@115V)
Max power factor	0.95
EMC protection	4000V (per EN61000-6-2)
Insulation class	Class A (105°C)
Electronic protection	Locked rotor and automatic thermal de-rating also included
Refrigerant compatibility	HFC, CO ₂ and hydrocarbon (per IEC60335-2-89 Annex BB)
IP rating	IP67
Operating temp. range	-30°C to +50°C (-22°F to +122°F)
Storage temp. range	-40°C to +80°C (-40°F to +176°F)
Weight	0.86kg (1.9lb)
Approvals	    

WIRING DIAGRAM

For single speed operation



For three speed or reversible operation

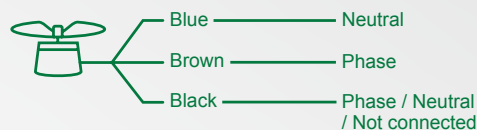

For variable speed operation

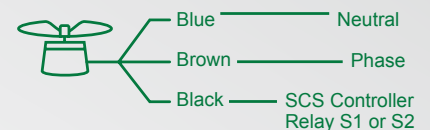

DIMENSIONS

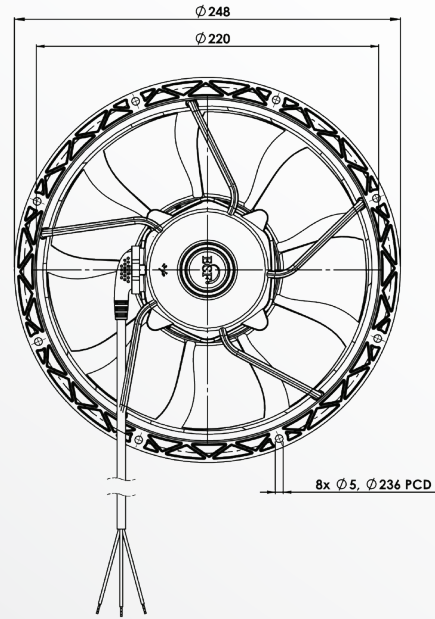
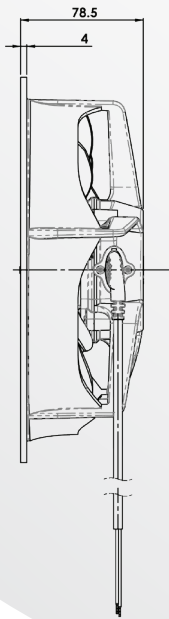

AIRFLOW DATA

Fan Speed N [RPM]	Input Power Pe [W]	Sound Pressure* LpA [dB(A)]	Inlet Sound Power Level ** LwA [dB(A)]	Static Pressure P [Pa]	Airflow Q [m³/hr]
1325	6.8	42.4	49.4	5	432.0
1325	7.5	41.7	48.7	15	377.1
1325	7.5	44.3	51.3	20	291.8
1325	8.7	46.2	53.2	35	172.7
1325	9.9	47.3	54.3	50	107.7
1500	9.8	44.9	51.9	5	505.2
1500	10.5	44.5	51.5	15	464.9
1500	10.8	44.7	51.7	20	431.9
1500	11.1	50.1	57.1	35	232.2
1500	12.8	50.0	57.0	50	179.1
1800	14.6	49.1	56.1	5	606.5
1800	16.2	48.7	55.7	15	581.7
1800	17.3	48.8	55.8	20	566.7
1800	17.8	48.9	55.9	35	452.7
1800	18.2	54.7	61.7	50	283.5

* Average inlet sound pressure, measured according to ISO 10302-1, measured at 1m radius

** Inlet sound power equivalent according to ISO 13347-1

OEM OPTIONS

- Preprogrammed or factory/field programmable speeds
- Realtime continuously variable speed control over third mains wire (no extra cables required)
- Custom cable and plug options
- Metric, imperial, or custom hardware
- 3 speed, reversible, or timed-reverse options

AIRFLOW GRAPH

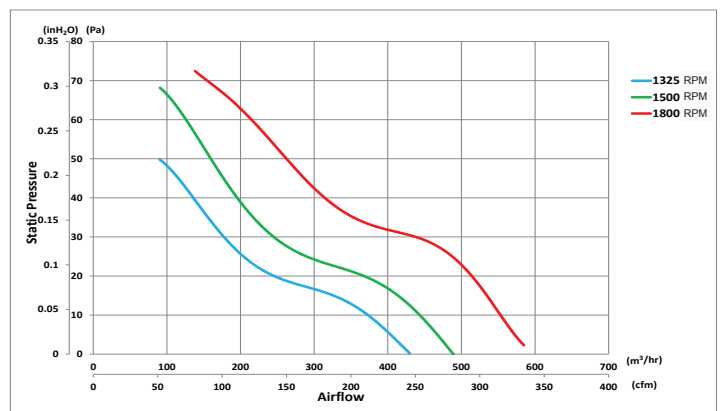

21 Arrenway Drive, Rosedale, Auckland 0632, PO Box 302-533 North Harbour, Auckland 0751, New Zealand

P: +64 (9) 477 4500 E: info@wdtl.com www.wdtl.com