

Look up to the sky and imagine a future that resonates circular clean energy. Gaze down into the earth and honor our groundwater. Our designs bridge the profound recordings of the past, and a culturally inclusive global future. Draw inspiration from ancient observations of electromagnetism in the sky, plasma's voluminous forms seen in petroglyphs, spacecraft photographs, and demonstrated in labs. Discover a pictograph-based communication in pre-history and its continued evolution towards a universal language. Experience a sacred space that recharges the groundwater, where one descends into the cool earth, to rest and honor the aquifer. Water and energy sustain life.

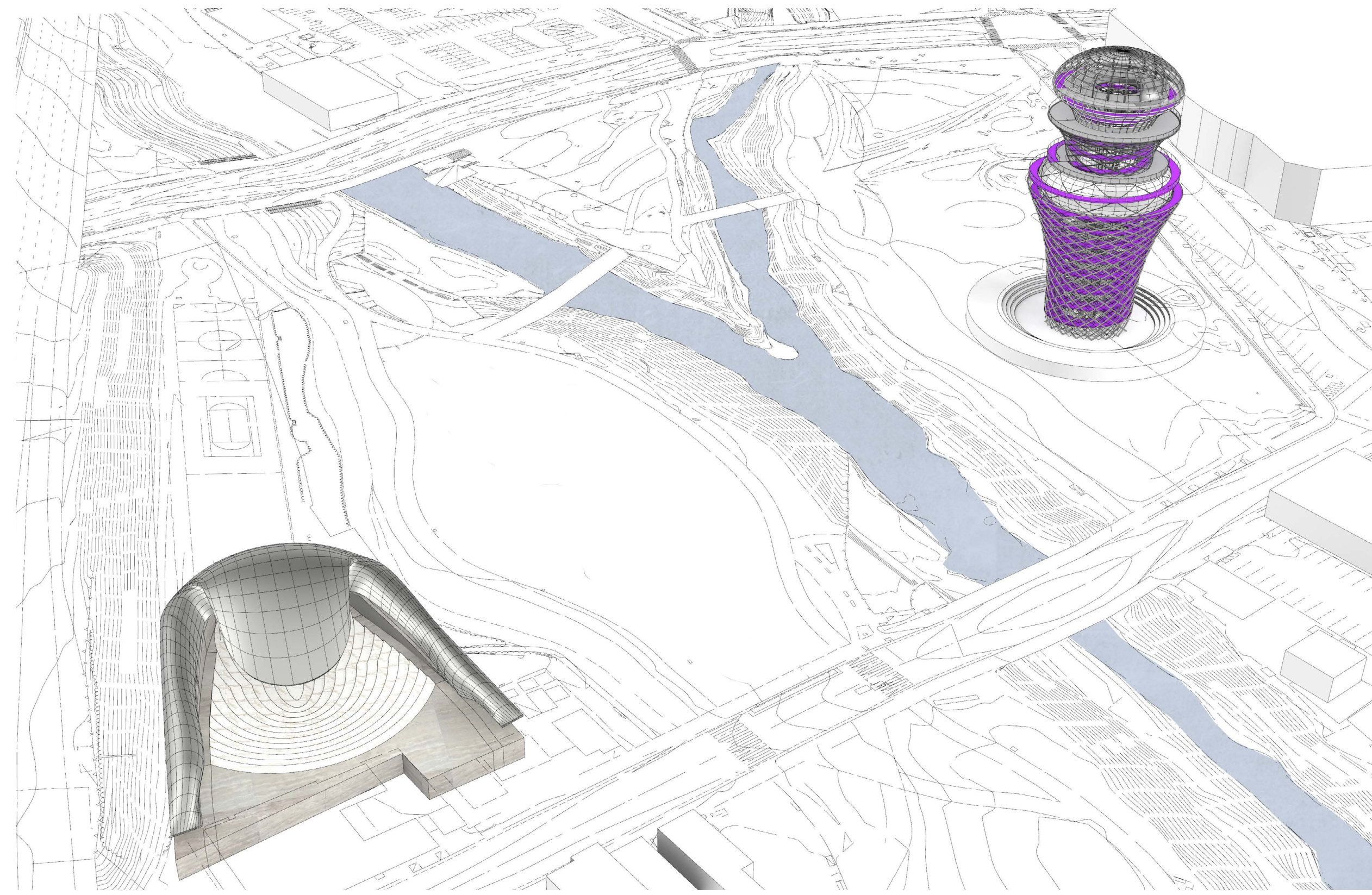

AERIAL VIEW OF BOTH SITES

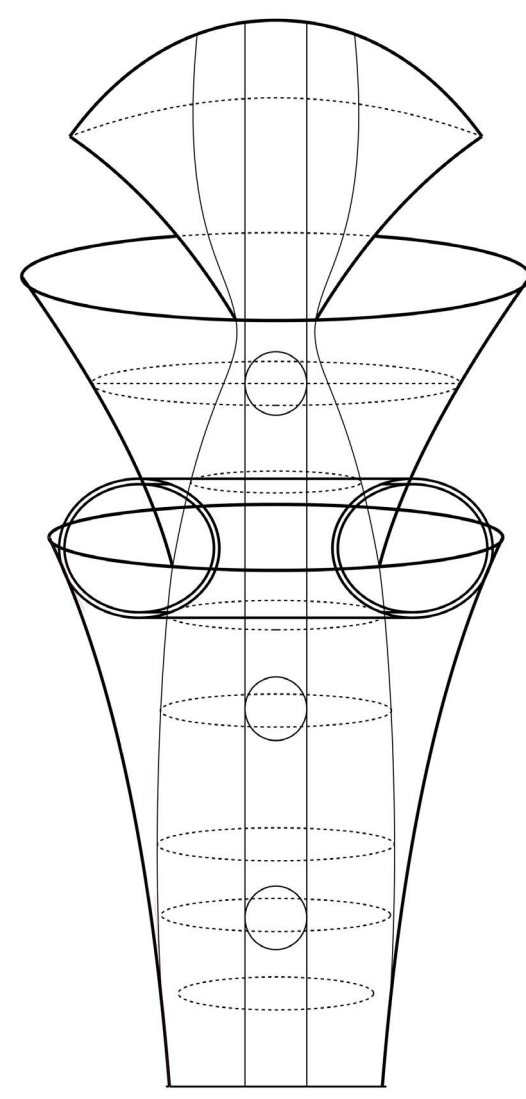

PLASMA ANALYTICAL SKETCH

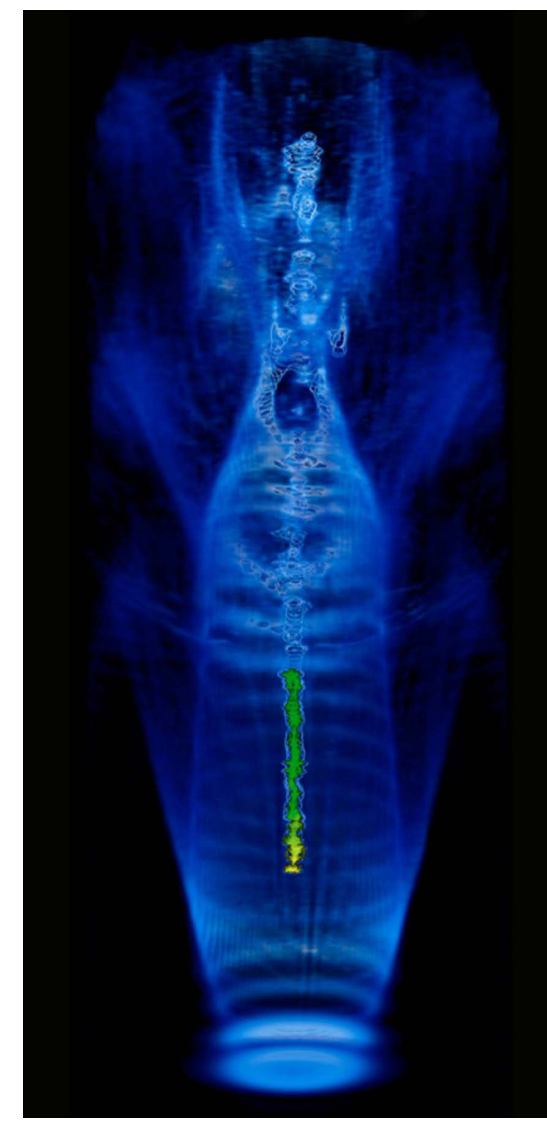

PLASMA LAB REASERCH GENERATOR



WARDENCLYFFE TOWER
NIKOLA TESLA, WIRELESS
POWER TRANSMISSION

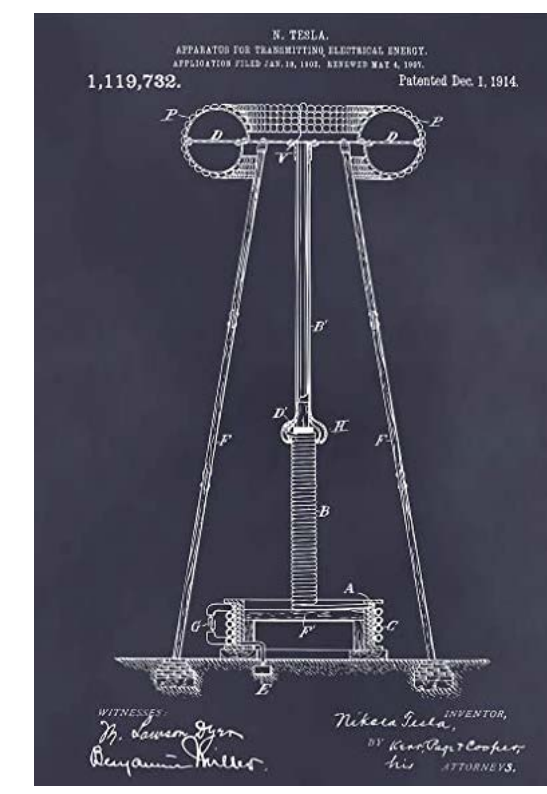

APPARATUS FOR TRANSMITTING,
ELECTRICAL ENERGY
NIKOLAS TESLA PATENT



PRE-HISTORY PETROGLYPH
STICK FIGURE



PRE-HISTORY PETROGLYPH
PIPETTE

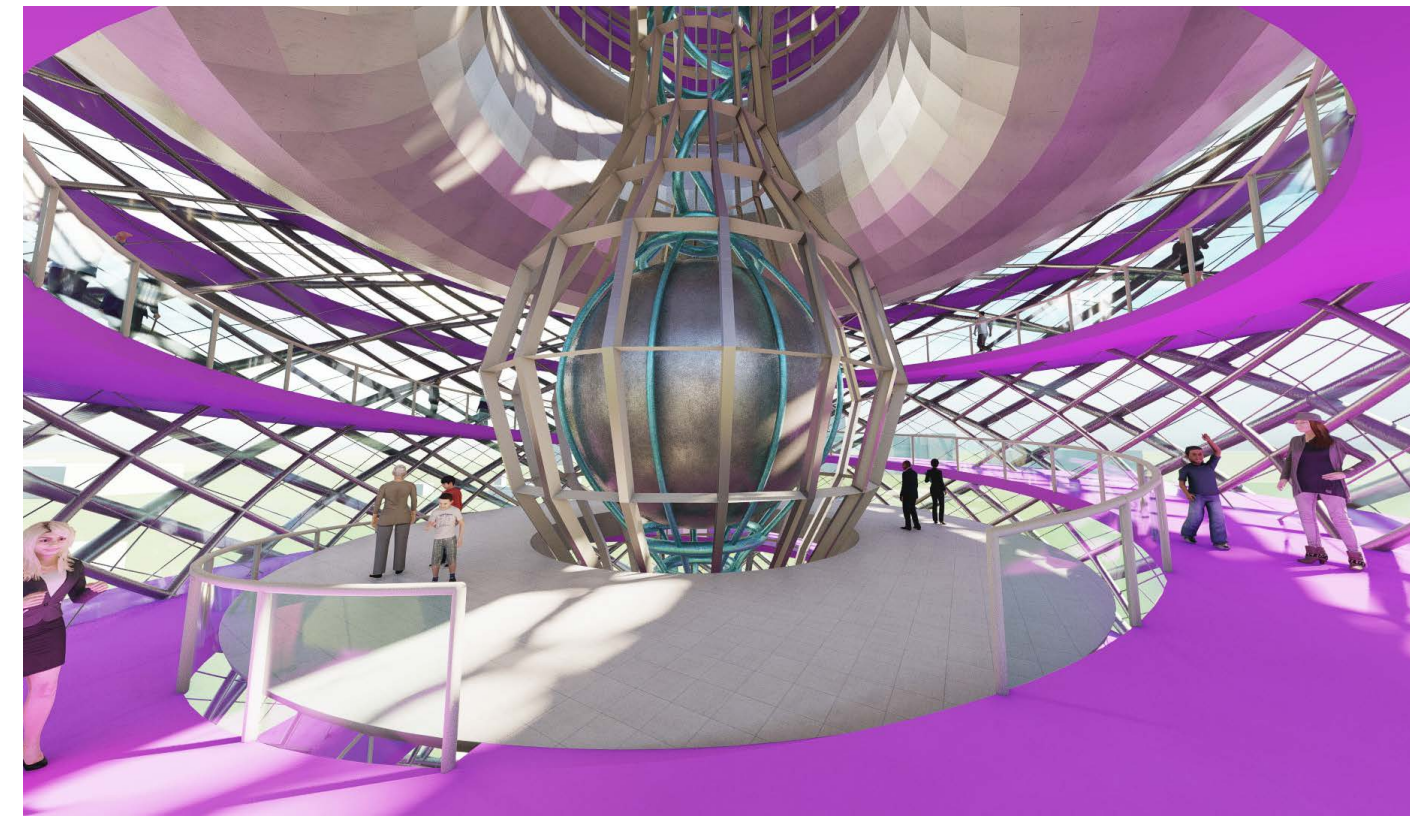
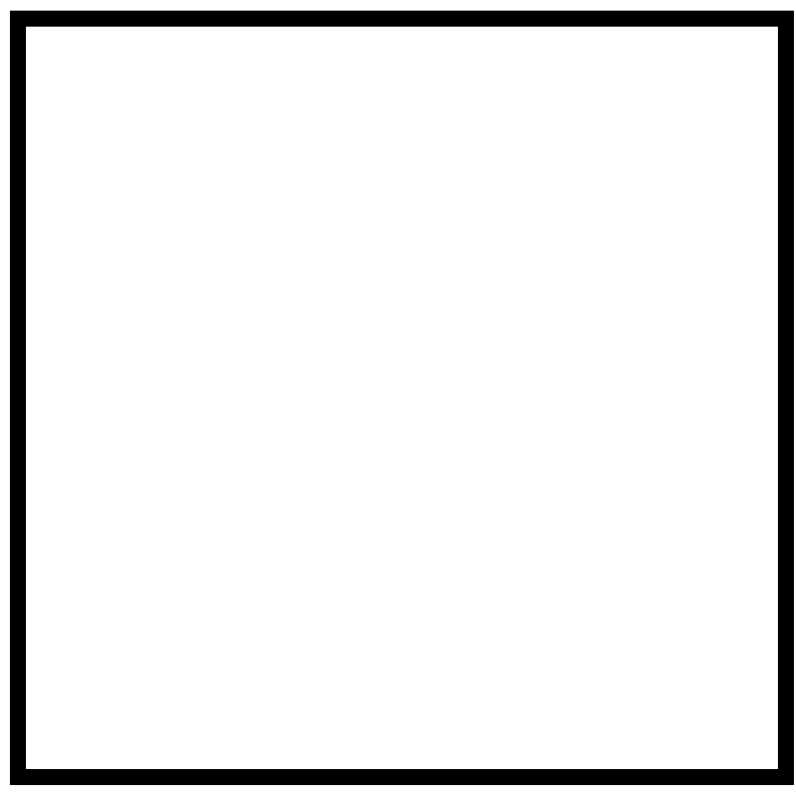

RAINCHAIN MID LEVEL

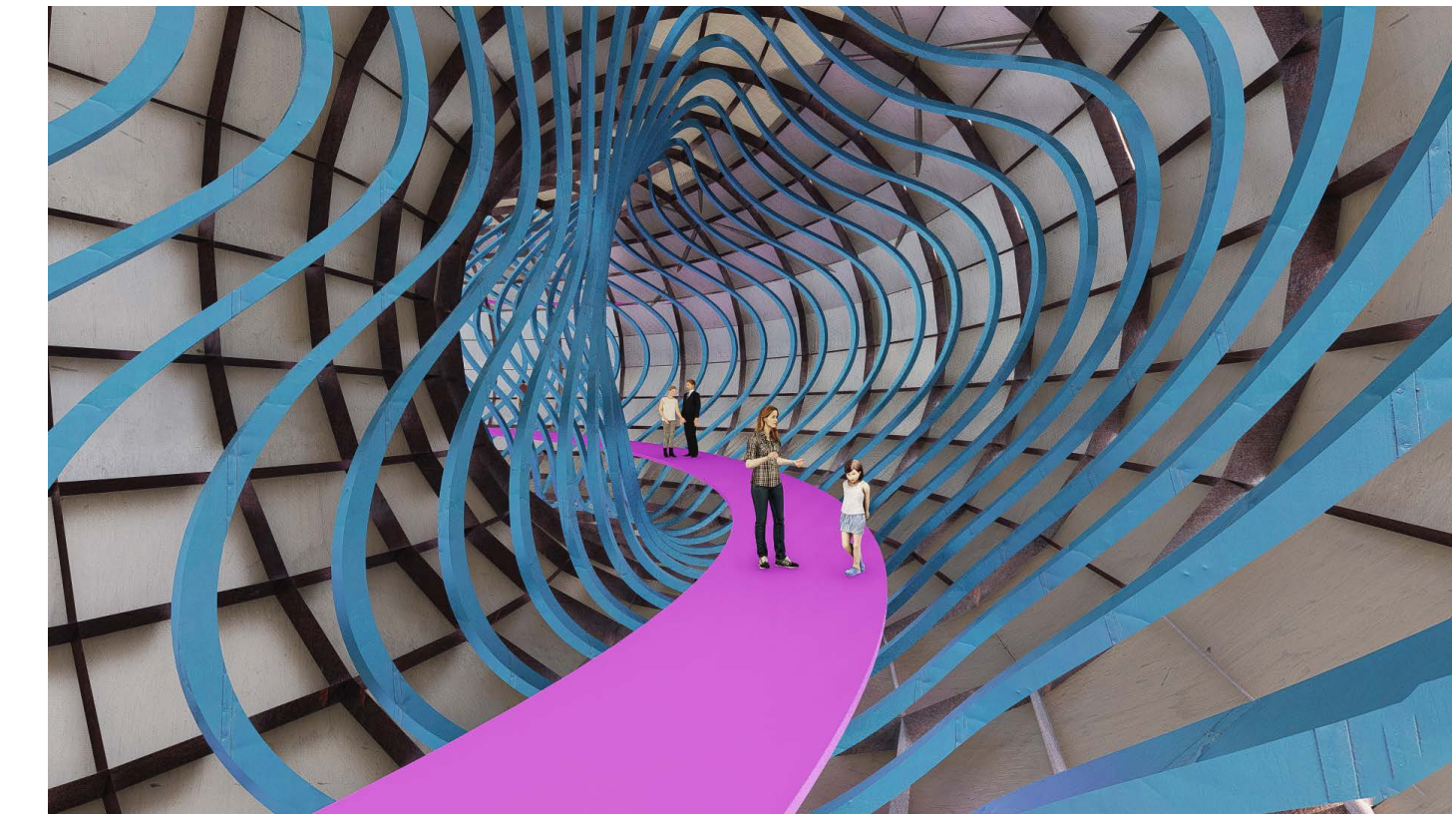

CLEAN ENERGY FUSION EXPERIENCE



PLAMA PHYSICS

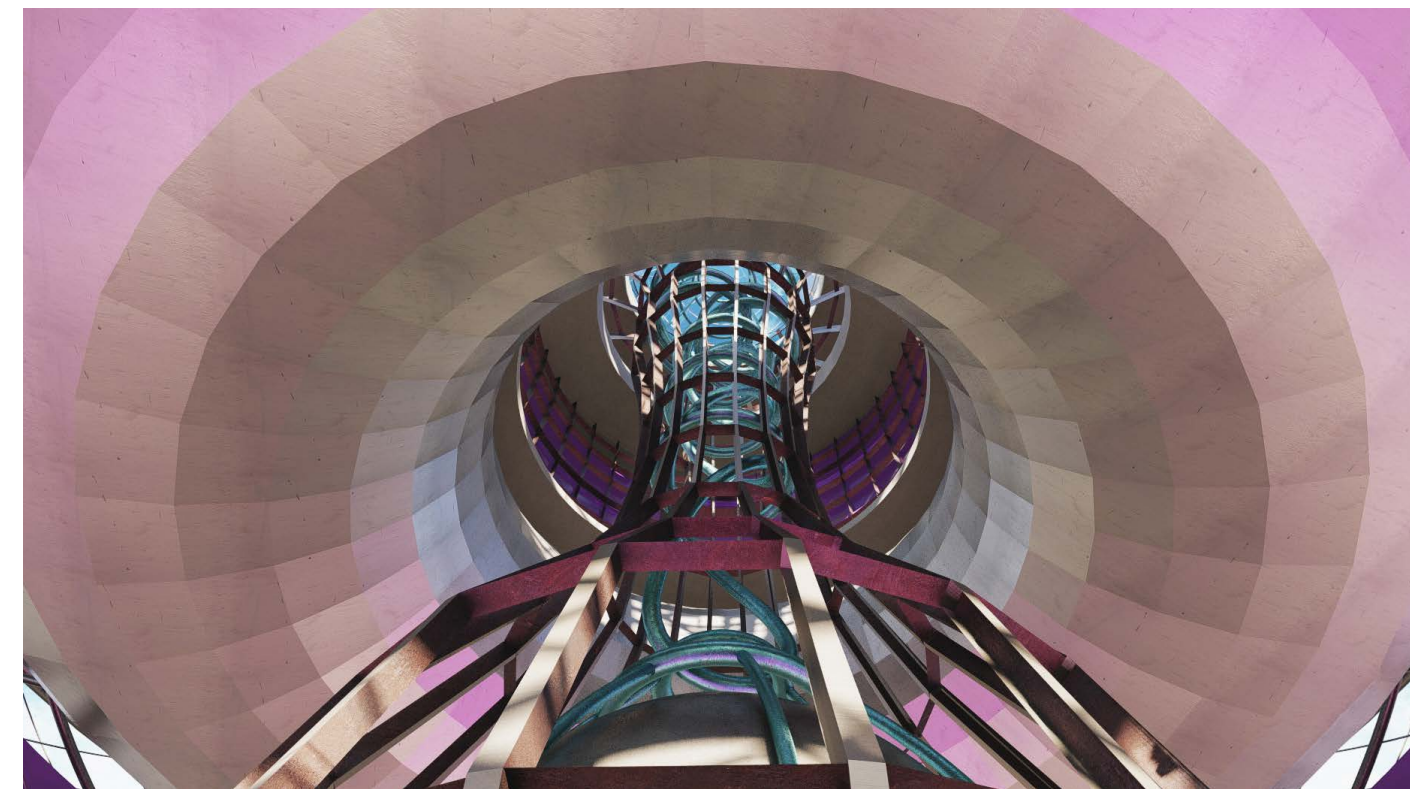

RAINCHAIN SCULPTURE

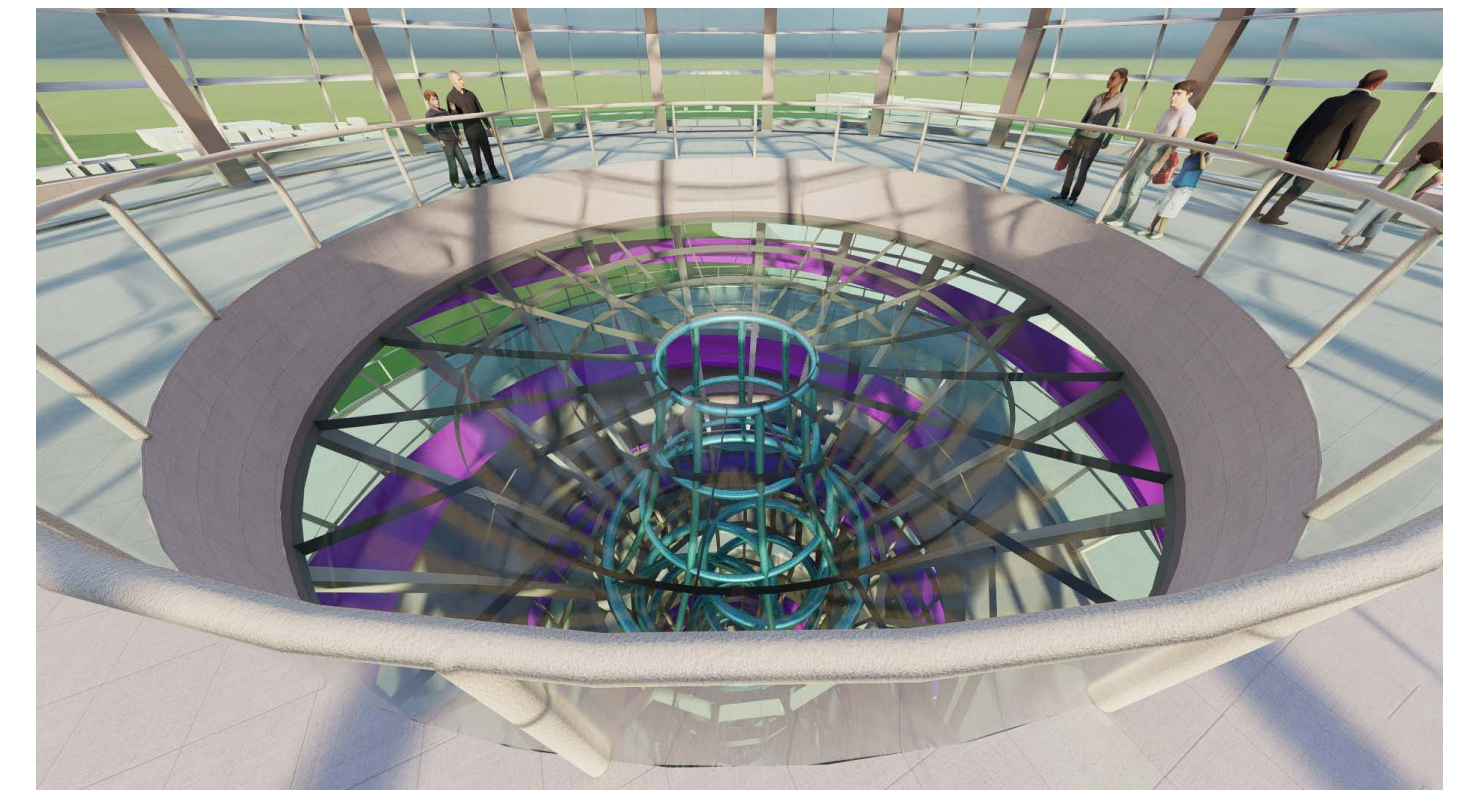

RAINWATER COLLECTION SYSTEM

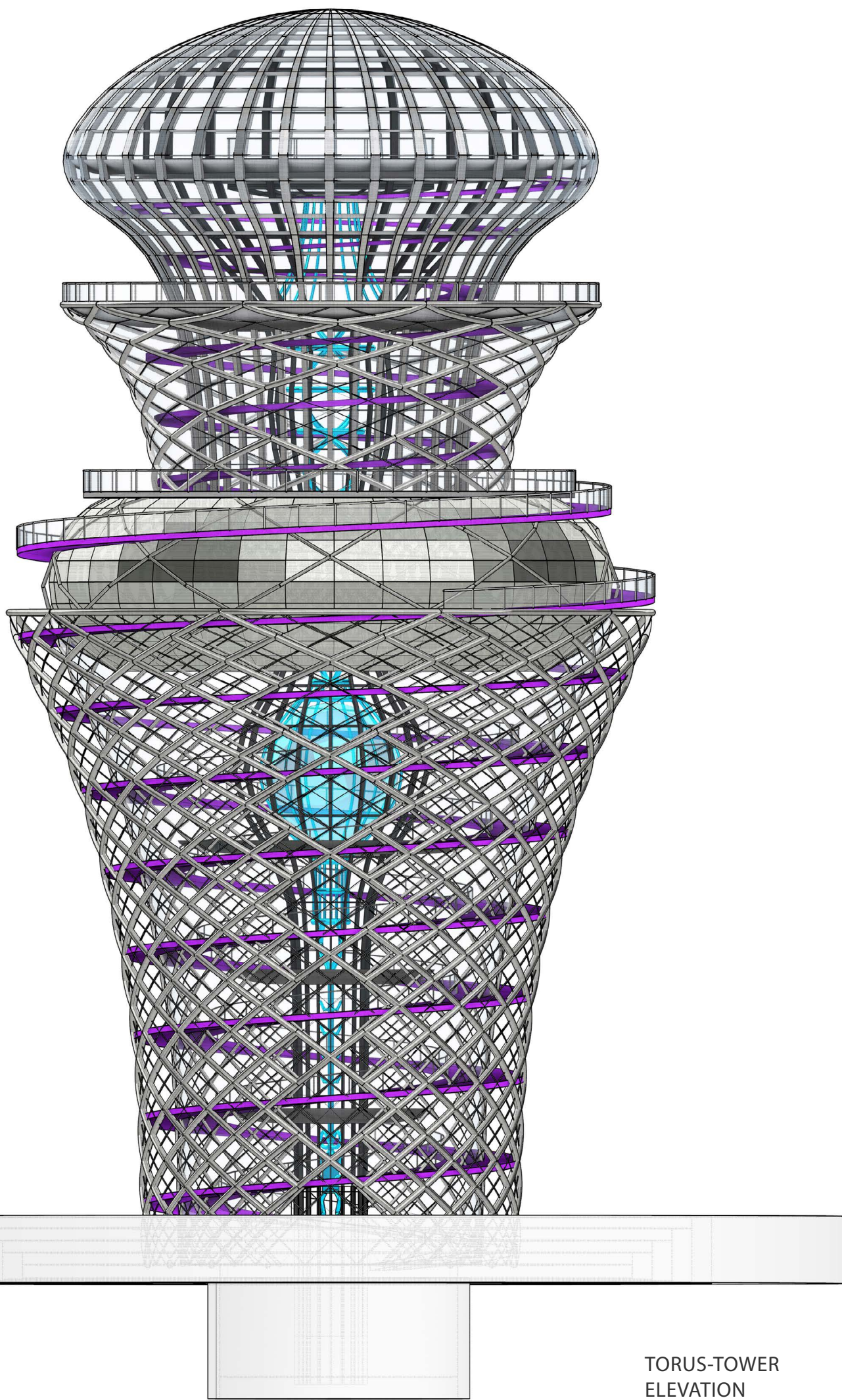

TORUS-TOWER
ELEVATION



RAINCHAIN
SKETCH

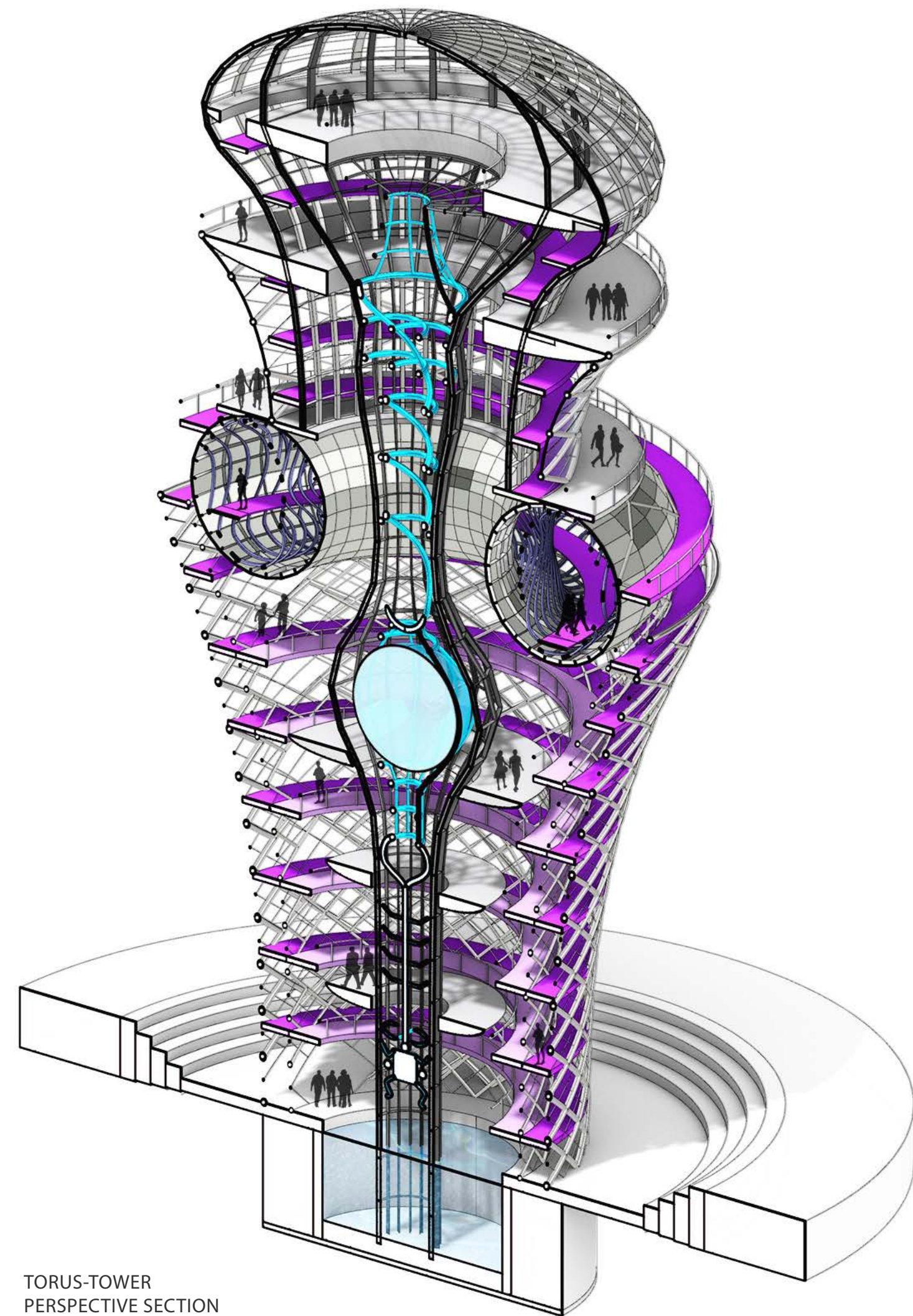

TORUS-TOWER
PERSPECTIVE SECTION

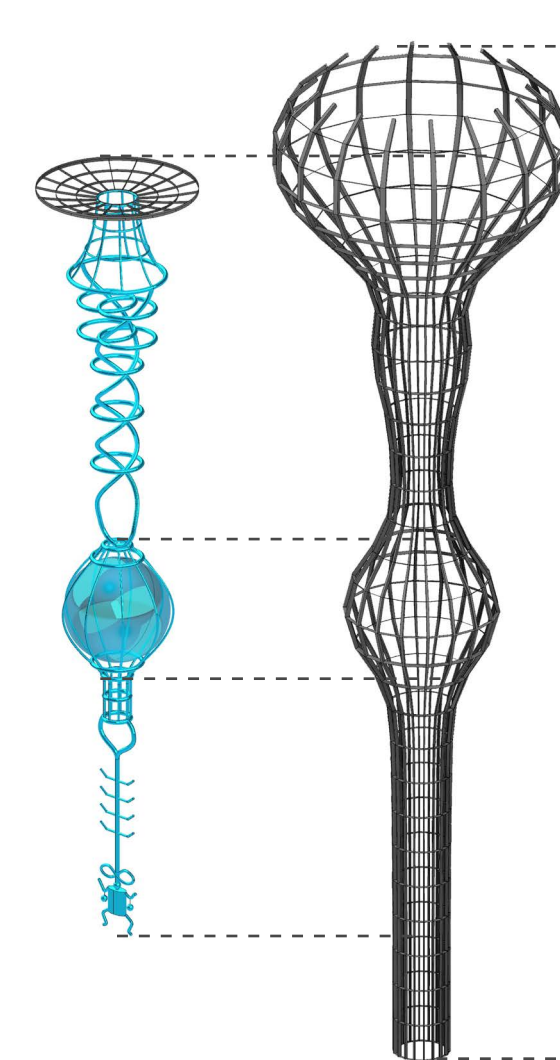

RAINCHAIN
SCULPTURE

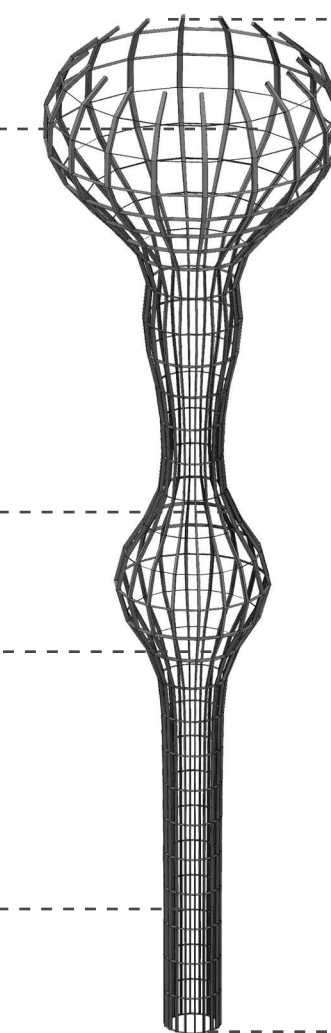

ATRIUM SUB STRUCTURE
SYSTEM

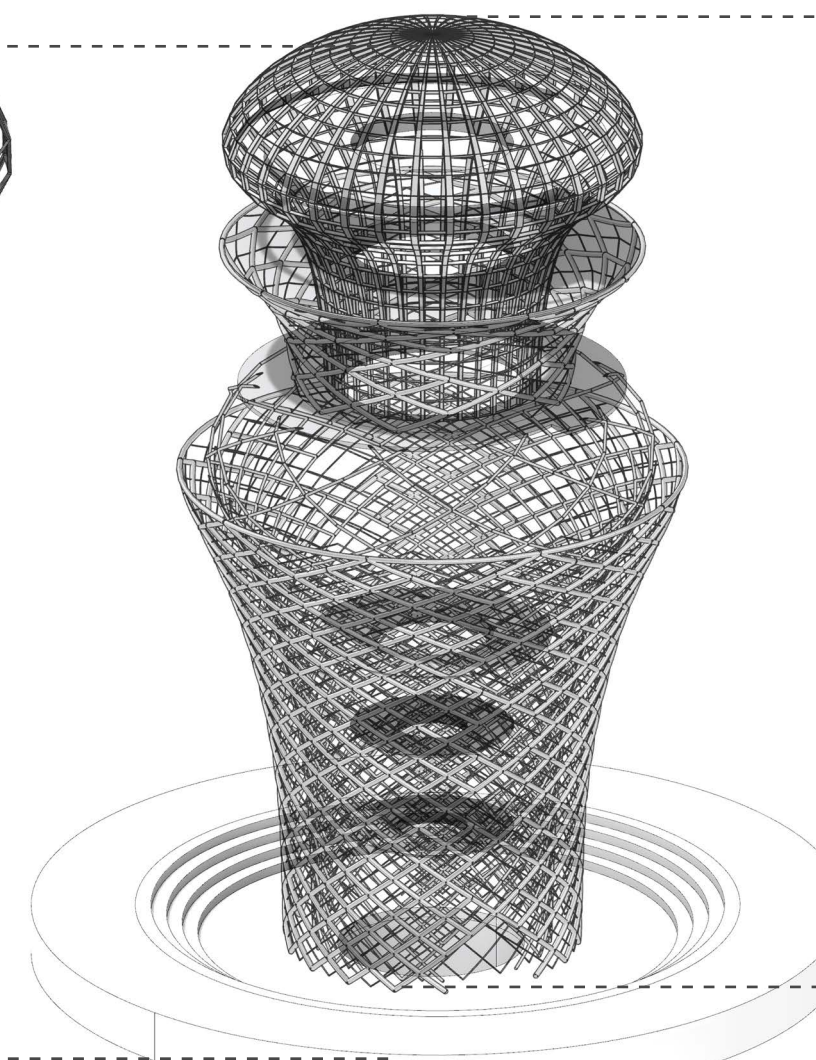

STRUCTURAL SYSTEM

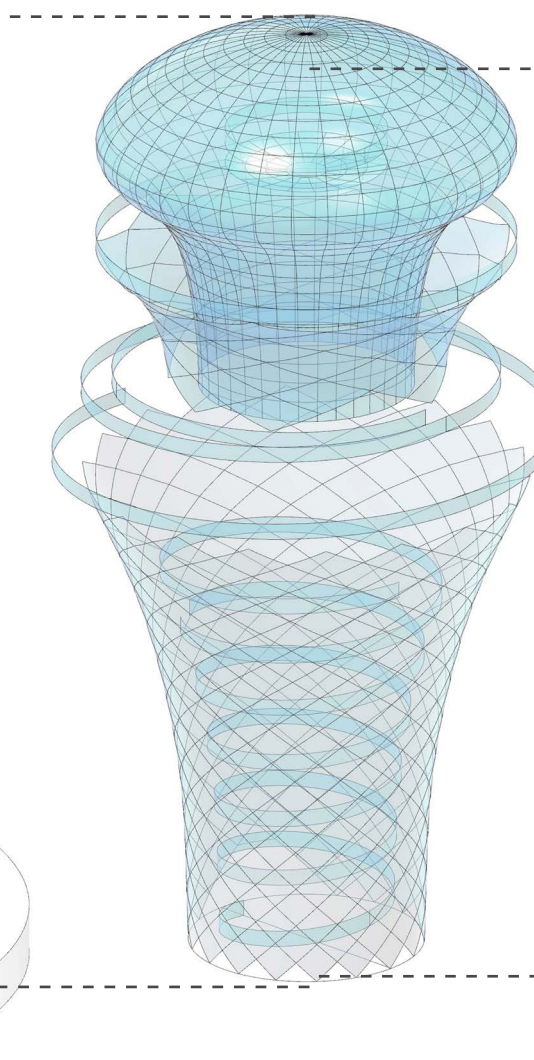

INTERIOR & EXTERIOR GLASS

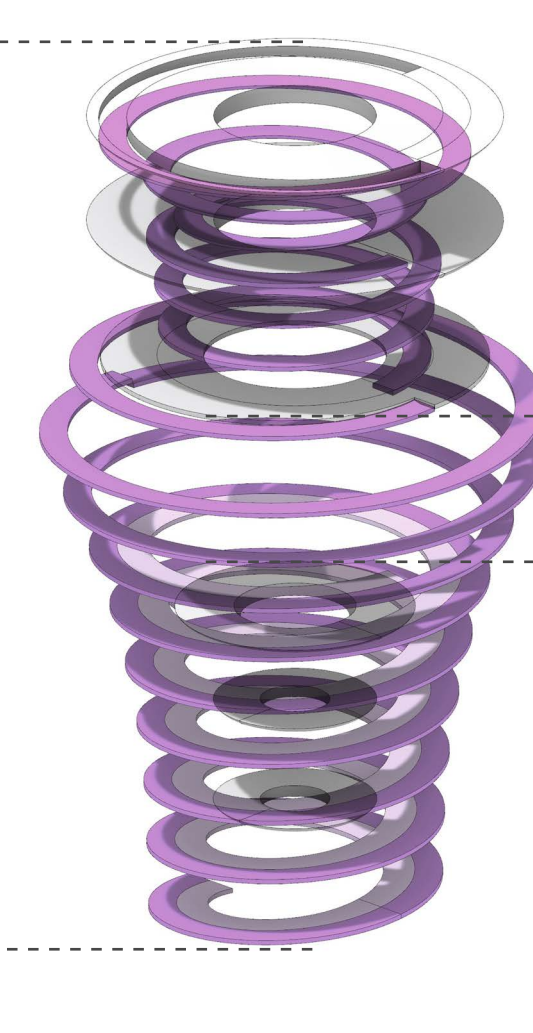

CIRCULATION

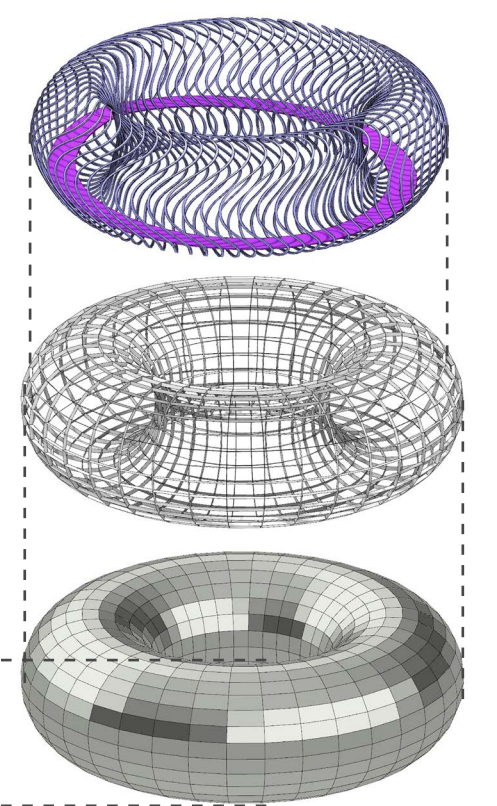

FUSION STRUCTURE &
CIRCULATION

PANELS STRUCTURE

FUSION EXPERIENCE
PANELS



MASTER PLAN



RECHARGE STEPWELL / ENTRANCE



TRADITIONAL INDIAN STEPWELL



OHLONE - DESIGN RELATED TO STEPWELL DESIGN

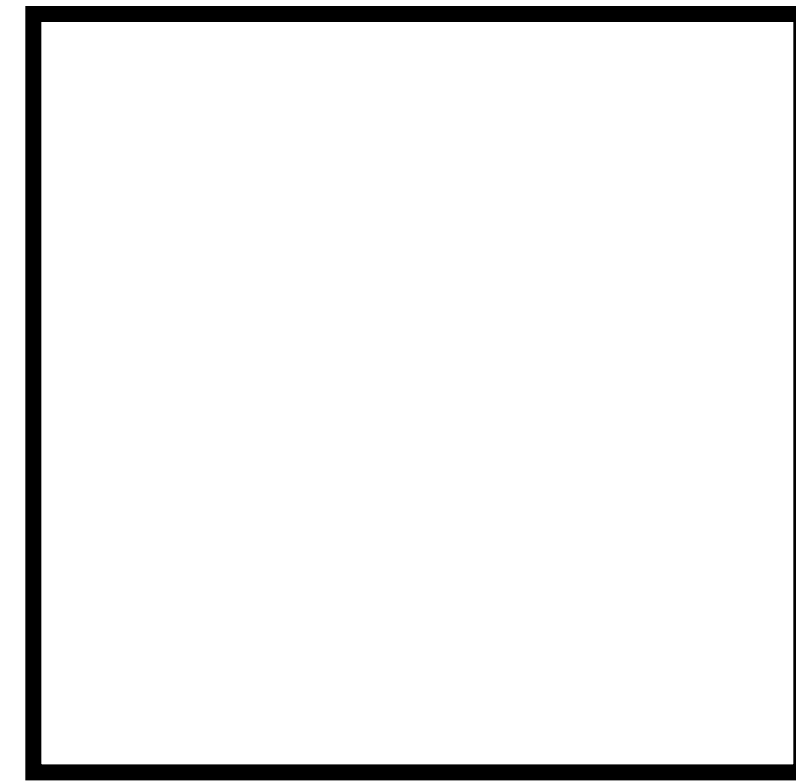

RECHARGE STEPWELL / CANOPY

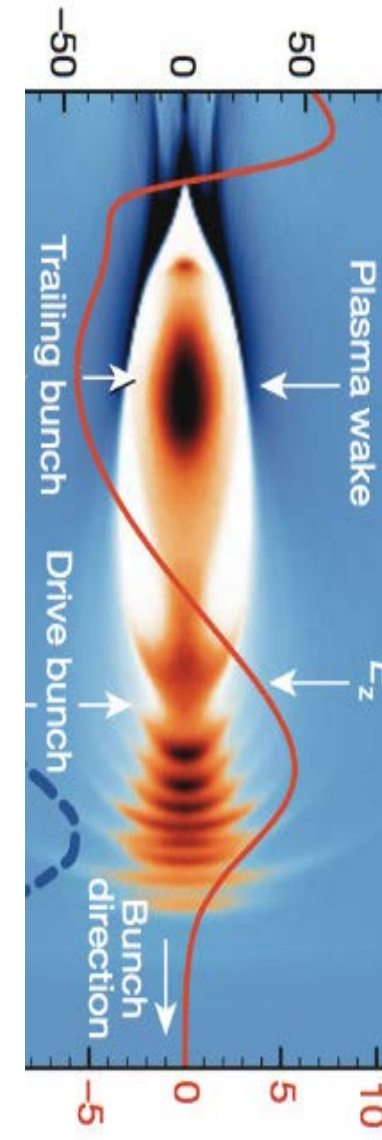

PLASMA ACCELERATION

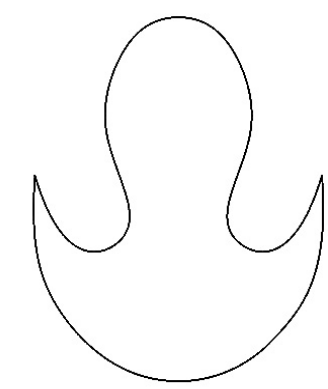

PLASMA MORPHOLOGY DIAGRAM

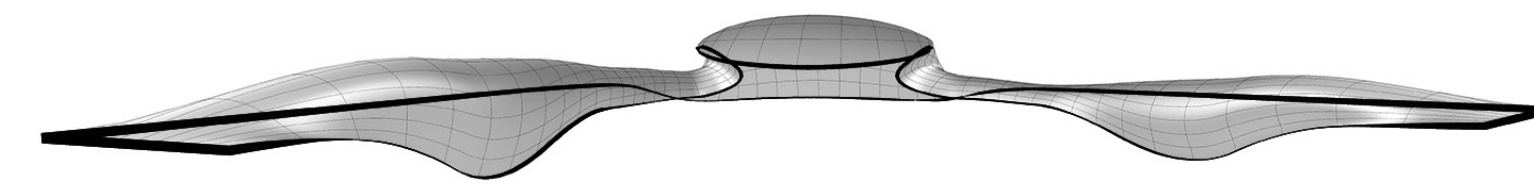

PLASMA MORPHOLOGY ANALYSIS

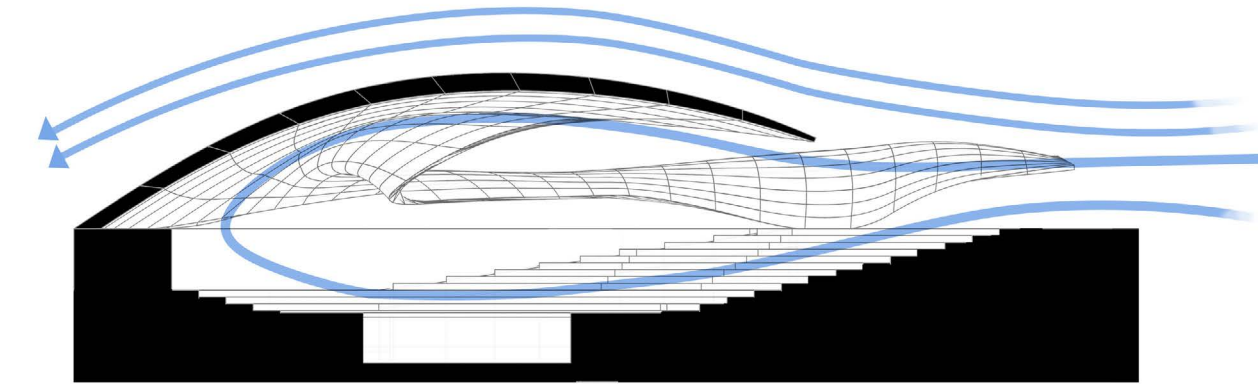

AERODYNAMICS VENTILATION & EVAPORATION PREVENTION

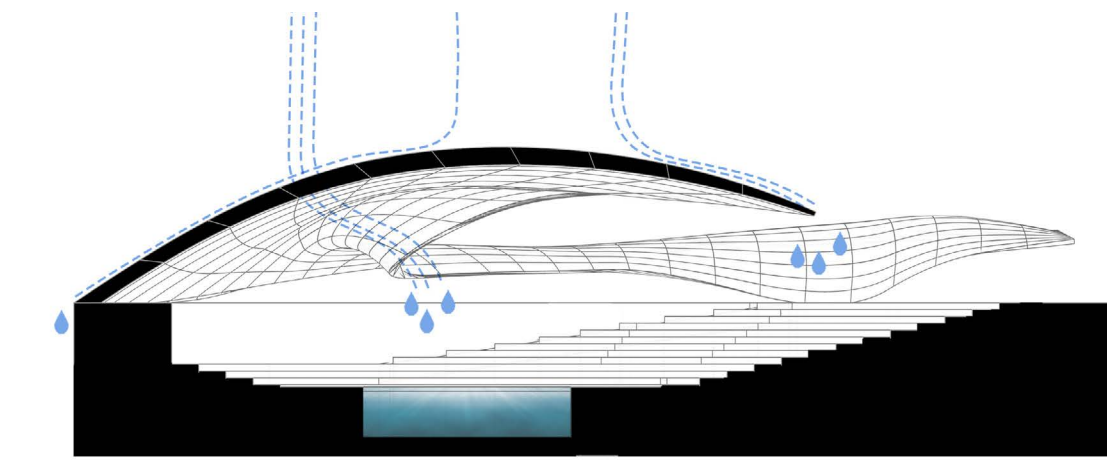

RAIN WATER COLLECTION SYSTEM
PERMACULTURE/ MOSQUITO FISH (GAMBUSIA AFFINIS)

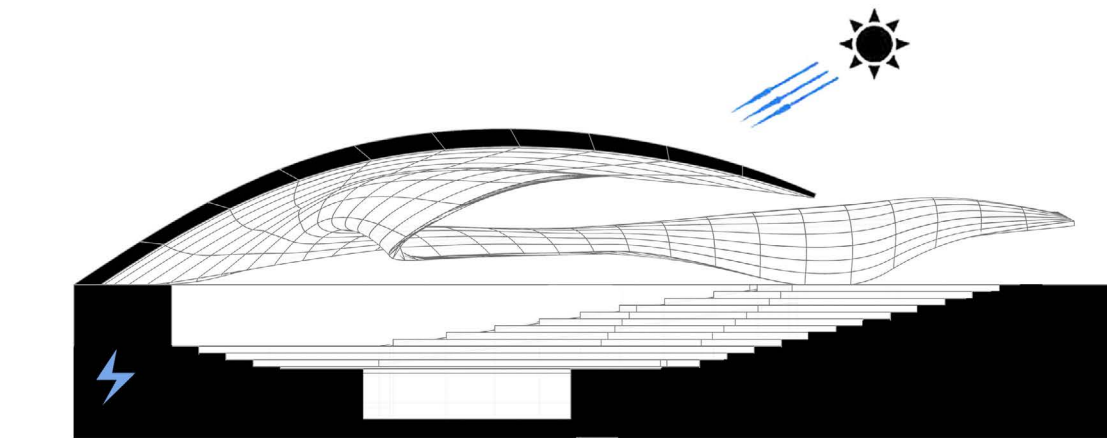

THIN FILM SOLAR CELLS, ENERGY STORAGE

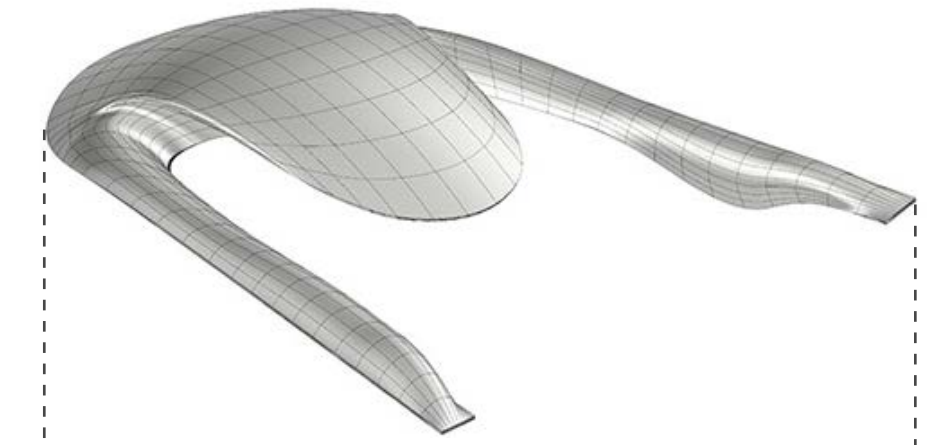

ALUMINUM PANELS & THIN FILM SOLAR CELLS

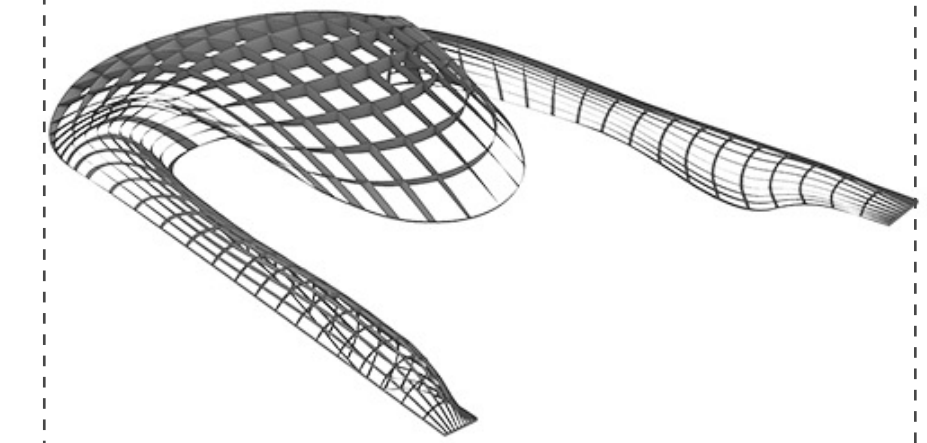

PANELS STRUCTURE

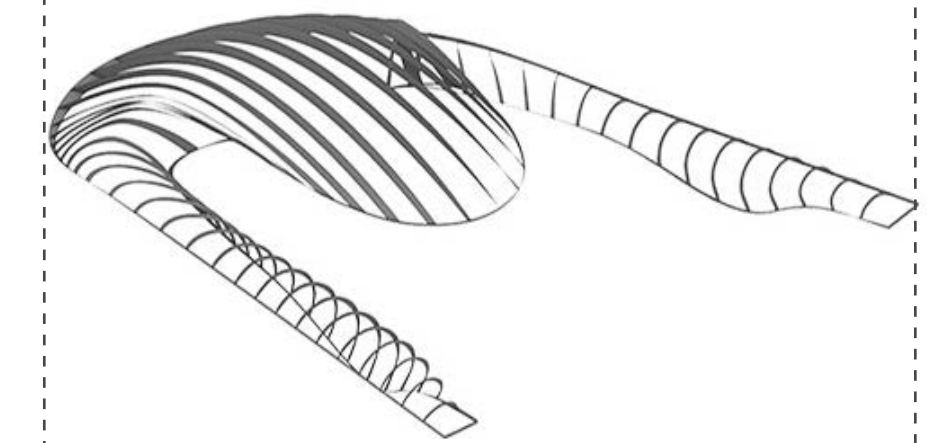

STEEL STRUCTURAL SYSTEM

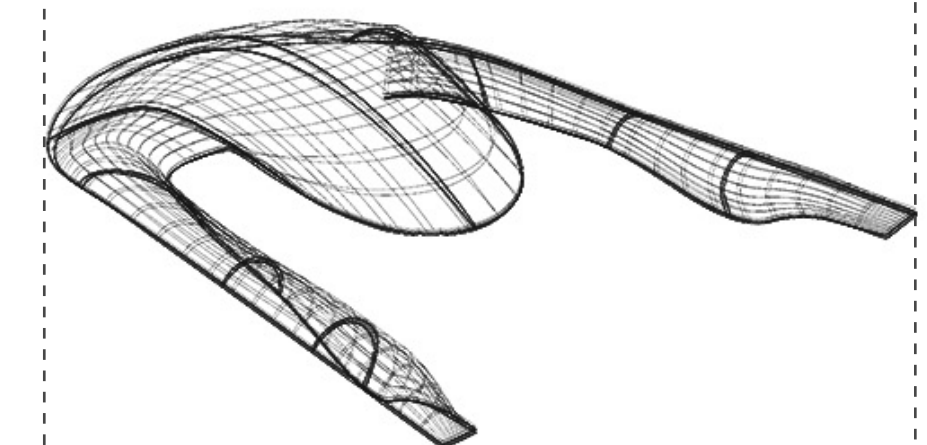

STEEL JOINT SYSTEM

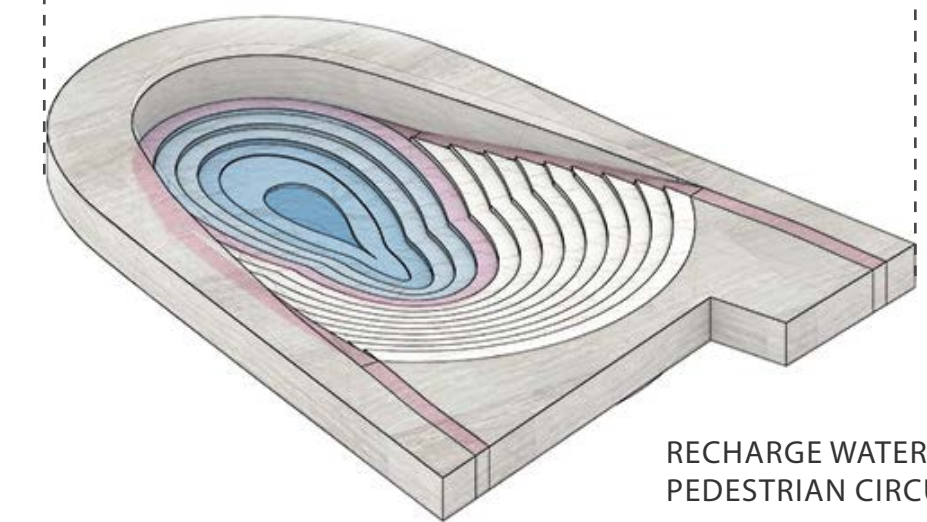

RECHARGE WATER COLLECTION LEVELS
PEDESTRIAN CIRCULATION



RECHARGE STEPWELL / TOP LOOP



RECHARGE STEPWELL / UNDERLOOP

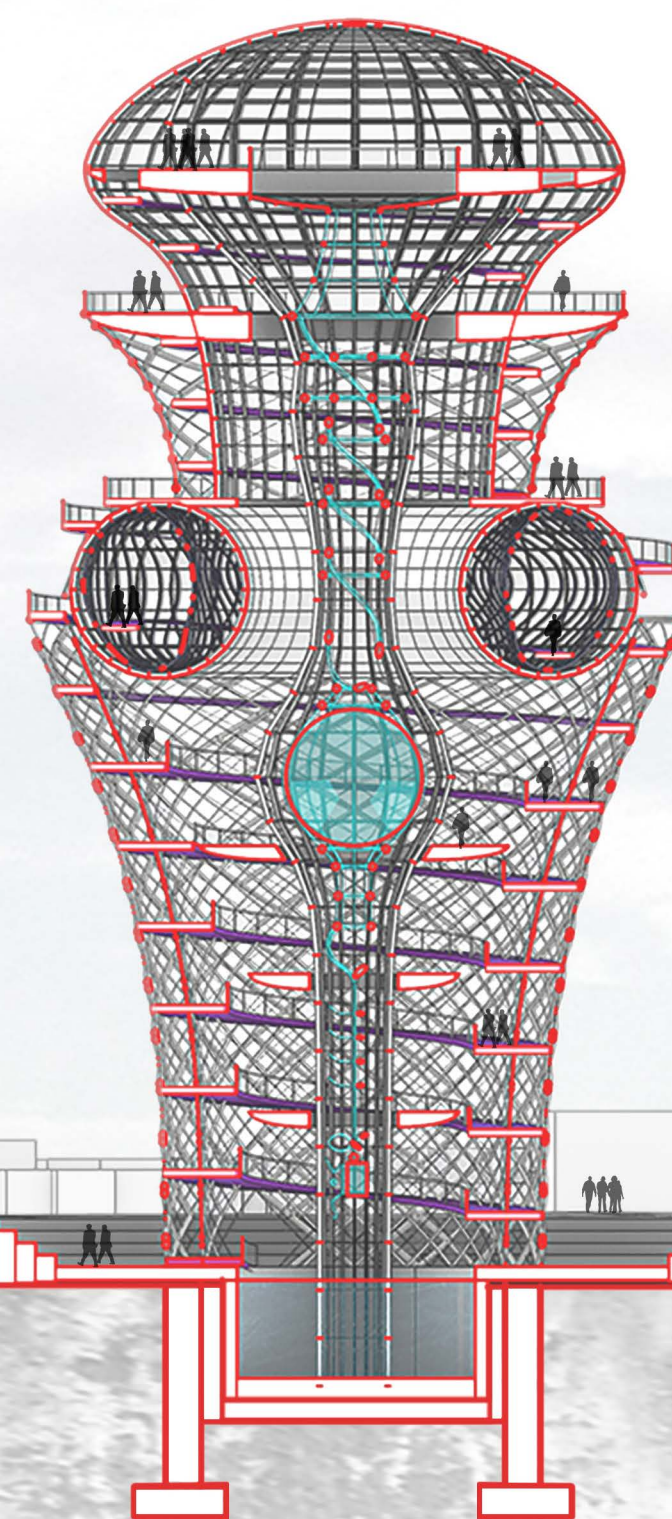

LONGITUDINAL SECTION

