

Surface Sensor USB

SPECIFICATION

The Surface Sensor, USB, available in a minimally-sized package, provides users with real-time occupancy availability. The Surface Sensor, optimized for easy deployment, mounts to light fixtures or ceiling tiles and under desks. Integrated sensors capture data that is both processed locally and transmitted over the Enlighted network, enabling a full suite of applications. In addition, the sensor supports Bluetooth® Low Energy communication with tags and other BLE devices.



OVERVIEW

The Surface Sensor, USB, is a complete sensing node powered by a low voltage power source. The sensor incorporates an optical Fresnel lens, providing occupancy coverage for a wide range of mounting heights for different applications. An innovative mount-based design or an adhesive strip included in the kit supports easy installation and maintenance.

The pre-installed mask on the lens, for desk occupancy applications, restricts the sensor's field of view to avoid false detection of motion for under-desk coverage. For room occupancy applications, remove the mask covering the sensor lens for a wider range of coverage.

The sensor must be connected to a low voltage power source. Enlighted's recommended solution includes the following:

- USB-A to micro USB-B or micro USB-A connector cable up to 8 m/26.2 ft in length
- AC/DC 5V with 10W or 3W external wall mounted power adapter

FEATURES

Edge Sensing: Local processing capability supports advanced sensing and detection algorithms, providing optimization of existing features and enabling future applications.

Bluetooth Low Energy: An embedded BLE radio allows the sensor to receive and transmit beacons.

Occupancy Sensing: A digital Passive Infrared (PIR) sensor supports precise motion identification while minimizing false detection events.

IoT Sensing Node: When configured as an IoT Node, the sensor streams comprehensive live data for use with Enlighted's real-time location, analytics, and API software products.

Standards-Based Networking and Security: The Enlighted 802.15.4 wireless network with AES-128 encryption delivers secure, reliable communication that coexists with Wi-Fi networks by sensing low-traffic channels and transmitting in bursts.

Data Privacy: The sensor captures occupancy data in the sensor coverage area. The sensor cannot directly reference or identify any natural person.

MOUNTING

The sensor is designed to be easily mounted into lighting fixtures, ceiling tiles using the adhesive tape, or mounted to the underside of the desk using either the adhesive tape or the bracket mount shipped with the sensor. For room occupancy sensing applications, remove the mask on the sensor lens.

For a typical 27" seated-height desk or 50" standing desk, mount the sensor to the underside of the desk 15-26" from the front edge and at least 5" from the rear edge of the desk. After installation, the sensor lens must be facing the desk occupant.

Surface Sensor, USB

L	2.0"	50.8 mm
W	0.53"	13.4 mm
Depth	0.56"	14.2 mm

ENLIGHTED SPECIFICATION SUBMITTAL

Job Name:	<input type="text"/>
Job Number:	<input type="text"/>
Product Codes:	<input type="checkbox"/> SU-5i-USB-IoT
	<input type="checkbox"/> BRKT-SU5i-50
	<input type="checkbox"/> API-RTO-DSK-A-01
	<input type="checkbox"/> API-RTO-AREA-A-01
	<input type="checkbox"/>
	<input type="checkbox"/>

Surface Sensor USB

SENSOR COVERAGE PATTERNS

The Surface Sensor incorporates an optical Fresnel lens that works with the digital Passive Infrared (PIR) sensor to detect occupancy and motion. The multifaceted lens focuses light onto the PIR to produce an all-encompassing field of view through the aggregation of many narrow fields of view. When the sensor is deployed as recommended, the area covered by each sensor overlaps, reinforcing coverage and accuracy across the entire floor plan.

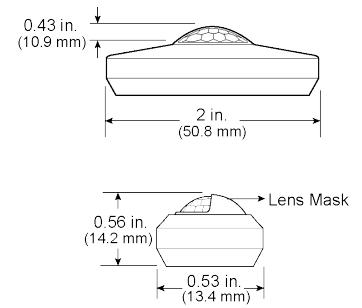

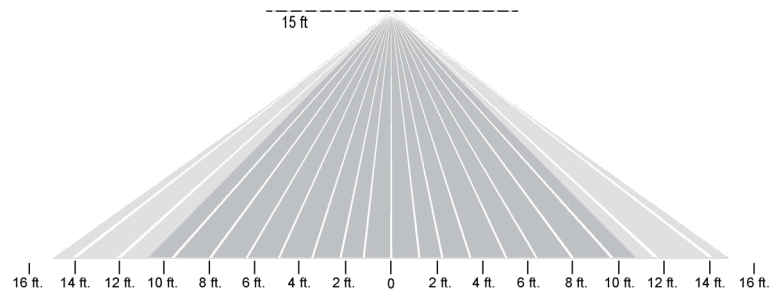
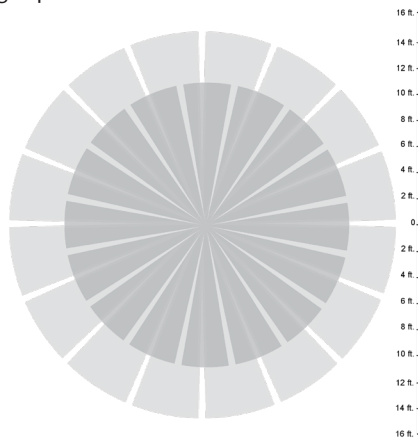

Height	Minor Motion (Radius)	Major Motion (Radius)
Ceiling 8.5 ft/2.6 m	7.2 ft/2.2 m	8.9 ft/2.7 m
Ceiling 10 ft/3.0 m	8.4 ft/2.5 m	10.5 ft/3.2 m
Ceiling 15 ft/4.6 m	11 ft/3.3 m	14.5 ft/4.4 m
Desk 27" or 50 inches		32 inches

Ceiling Top and Side View

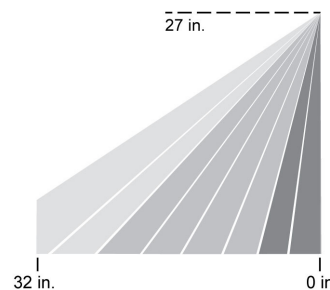
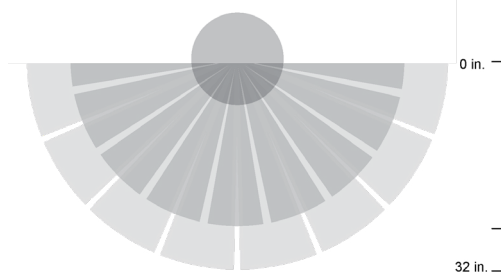

Desk Top and Side View



Major Motion 
Minor Motion 

TECHNICAL SPECIFICATIONS

Mount Adhesive: One VHB Adhesive Strip
Mount Bracket: Polycarbonate Polymer, ~5 grams weight, Two #4 0.5" wood screws
Operating Temp: 32° to 122° F / 0° to 50° C
Operating Humidity: 0 to 85% RH, non-condensing
Maximum Input Power:
 USB Port: ~120mW
Maximum RF Output Power:
 RF Output IEEE 802.15.4: 3-4dBm
 BLE: 0 dBm
Wireless Standards: IEEE 802.15.4
 Bluetooth 4.0 Low Energy (BLE)
 Radio Frequency: 2400-2483.5 MHz
 Wireless Range: 150 ft. (46 m) radius open range

ORDERING INFORMATION

SU-5i-USB-IoT Surface Sensor, USB
 BRKT-SU5I-50* Mount Bracket
 API-RTO-DSK-A-01 Desk Occupancy API
 API-RTO-AREA-A-01 Area Occupancy API

COMPLIANCE

Europe  
 United States  
 Canada  

WARRANTY: 5 years

View www.enlightedinc.com/limited-warranty-terms for complete terms and conditions

*Optional 50-pack of the brackets with screws sold separately.

The Bluetooth® word mark and logos are registered trademarks owned by Bluetooth SIG, Inc. and any use of such marks by Enlighted Inc. is under license. Other trademarks and trade names are those of their respective owners.