

# Galaxy VX

## UPS System

### Operation

04/2020



# Legal Information

The Schneider Electric brand and any trademarks of Schneider Electric SE and its subsidiaries referred to in this guide are the property of Schneider Electric SE or its subsidiaries. All other brands may be trademarks of their respective owners.

This guide and its content are protected under applicable copyright laws and furnished for informational use only. No part of this guide may be reproduced or transmitted in any form or by any means (electronic, mechanical, photocopying, recording, or otherwise), for any purpose, without the prior written permission of Schneider Electric.

Schneider Electric does not grant any right or license for commercial use of the guide or its content, except for a non-exclusive and personal license to consult it on an "as is" basis. Schneider Electric products and equipment should be installed, operated, serviced, and maintained only by qualified personnel.

As standards, specifications, and designs change from time to time, information contained in this guide may be subject to change without notice.

To the extent permitted by applicable law, no responsibility or liability is assumed by Schneider Electric and its subsidiaries for any errors or omissions in the informational content of this material or consequences arising out of or resulting from the use of the information contained herein.

# Table of Contents

Important Safety Instructions — SAVE THESE	
INSTRUCTIONS .....	5
FCC Statement .....	6
Safety Precautions .....	6
Overview of UPS User Interface .....	7
Overview of Mimic Diagram .....	8
Overview of Status LEDs .....	8
Display Symbols .....	9
Operation Modes .....	10
UPS Operation Modes .....	10
System Operation Modes .....	13
Frequency Converter Mode .....	14
UPS Display .....	15
UPS Display Menu Tree .....	15
Configuration from the UPS Display .....	16
Disable Password Request .....	16
Add a New User or Edit an Existing User .....	16
Delete a User .....	17
Configure the Display Preferences .....	17
Configure the Display Settings .....	18
Configure the UPS Output Voltage Compensation .....	18
Configure High Efficiency Mode .....	19
Enable Peak Shaving Mode .....	20
Set the UPS Identification .....	21
Configure the Input Contacts .....	22
Configure the Output Relays .....	23
Configure Reminder Settings .....	24
Configure Battery Alarm Threshold .....	25
Configure Automatic Battery Test .....	25
Configure the Network .....	26
Configure the Modbus .....	28
Restore Default Configuration .....	28
Operation Procedures from the UPS Display .....	29
Access Password-Protected Screens .....	29
View the System Status Information .....	29
Start Up Single System from Maintenance Bypass Operation .....	33
Shut Down Single System from Normal to Maintenance Bypass	
Operation .....	34
Transfer UPS from Normal to Requested Static Bypass	
Operation .....	35
Transfer UPS from Requested Static Bypass Operation to Normal	
Operation .....	35
Start Up Parallel System from Maintenance Bypass Operation .....	36
Shut Down Parallel System from Normal to Maintenance Bypass	
Operation .....	36
Start Up and Add UPS to a Running Parallel System .....	37
Isolate this Single UPS from the Parallel System .....	37

- Start-Up System Operating as Frequency Converters..... 38
- Shut Down System Operating as Frequency Converters ..... 38
- Start a Boost Charge of the Batteries..... 38
- Access a Configured Network Management Interface ..... 39
- Troubleshooting from the UPS ..... 40
  - Troubleshooting via the Mimic Diagram LEDs ..... 40
  - Reboot the Display..... 41
  - Logs ..... 41
  - View the Active Alarms ..... 44
- Tests ..... 50
  - Perform a Battery Test..... 50
  - Perform a Runtime Calibration ..... 51
  - Perform a Battery SPoT Mode Test ..... 51
  - Perform an Annunciators Test..... 52
  - Calibrate the Display ..... 52
- 10" System Bypass Display..... 53**
  - 10" System Bypass Display Menu Tree (Option) ..... 53
  - Configuration from the 10" System Bypass Display (Option) ..... 53
    - Configure the Display Settings ..... 53
    - Change the User Password ..... 54
    - Change the System Names ..... 55
    - Configure the Output Distribution Breakers ..... 56
  - Operation Procedures from the 10" System Bypass Display (Option)..... 56
    - Access Password-Protected Screens ..... 56
    - View the Parallel System Status..... 56
    - View System Bypass Status ..... 58
    - View UPS Status Information ..... 58
    - Transfer the Parallel System from Normal to Requested Static Bypass Operation ..... 61
      - Transfer the Parallel System from Requested Static Bypass to Normal Operation ..... 62
    - Connect to the 10" System Bypass Display Remotely ..... 62
  - Troubleshooting from the 10" System Bypass Display (Option)..... 62
    - View the Display Log..... 62
    - View the Parallel System Log..... 63
    - View the Active Alarms ..... 64
- Maintenance ..... 65**
  - Replace the Top Filter ..... 65
  - Replace the Three Bottom Filters..... 65
- Troubleshooting ..... 67**
  - Determine if you need a Replacement Part..... 67
    - Find the Serial Numbers ..... 67
  - Return Parts to Schneider Electric ..... 67

# Important Safety Instructions — SAVE THESE INSTRUCTIONS

Read these instructions carefully and look at the equipment to become familiar with it before trying to install, operate, service or maintain it. The following safety messages may appear throughout this manual or on the equipment to warn of potential hazards or to call attention to information that clarifies or simplifies a procedure.



The addition of this symbol to a “Danger” or “Warning” safety message indicates that an electrical hazard exists which will result in personal injury if the instructions are not followed.



This is the safety alert symbol. It is used to alert you to potential personal injury hazards. Obey all safety messages with this symbol to avoid possible injury or death.

## **DANGER**

**DANGER** indicates a hazardous situation which, if not avoided, **will result in death or serious injury.**

**Failure to follow these instructions will result in death or serious injury.**

## **WARNING**

**WARNING** indicates a hazardous situation which, if not avoided, **could result in death or serious injury.**

**Failure to follow these instructions can result in death, serious injury, or equipment damage.**

## **CAUTION**

**CAUTION** indicates a hazardous situation which, if not avoided, **could result in minor or moderate injury.**

**Failure to follow these instructions can result in injury or equipment damage.**

## **NOTICE**

**NOTICE** is used to address practices not related to physical injury. The safety alert symbol shall not be used with this type of safety message.

**Failure to follow these instructions can result in equipment damage.**

## Please Note

Electrical equipment should only be installed, operated, serviced, and maintained by qualified personnel. No responsibility is assumed by Schneider Electric for any consequences arising out of the use of this material.

A qualified person is one who has skills and knowledge related to the construction, installation, and operation of electrical equipment and has received safety training to recognize and avoid the hazards involved.

## FCC Statement

**NOTE:** This equipment has been tested and found to comply with the limits for a Class A digital device, pursuant to Part 15 of the FCC Rules. These limits are designed to provide reasonable protection against harmful interference when the equipment is operated in a commercial environment. This equipment generates, uses, and can radiate radio frequency energy and, if not installed and used in accordance with the instruction manual, may cause harmful interference to radio communications. Operation of this equipment in a residential area is likely to cause harmful interference in which case the user will be required to correct the interference at his own expense.

Any changes or modifications not expressly approved by the party responsible for compliance could void the user's authority to operate the equipment.

## Safety Precautions

### **DANGER**

#### **HAZARD OF ELECTRICAL SHOCK, EXPLOSION OR ARC FLASH**

All safety instructions in this document must be read, understood and followed.

**Failure to follow these instructions will result in death or serious injury.**

### **DANGER**

#### **HAZARD OF ELECTRICAL SHOCK, EXPLOSION OR ARC FLASH**

After the UPS system has been electrically wired, do not start up the system. Start-up must only be performed by Schneider Electric.

**Failure to follow these instructions will result in death or serious injury.**

# Overview of UPS User Interface

The user interface consists of:

- A. Display interface
- B. Status LEDs
- C. Mimic diagram
- D. Inverter ON button
- E. Inverter OFF button
- F. USB port for export of logs
- G. Display reset button
- H. Network connection LED:
  - Solid green: The system has valid TCP/IP settings.  
See *Configure the Network*, page 26.
  - Flashing green: The system does not have valid TCP/IP settings.
  - Solid orange: The display is inoperable. Contact Schneider Electric.
  - Flashing orange: The system is making BOOTP requests.  
See *Configure the Network*, page 26.
  - Alternately flashing green and orange: If the LED is alternately flashing slowly, the system is making DHCP requests.  
See *Configure the Network*, page 26.
  - If the LED is alternately flashing rapidly, the system is starting up.
  - Off: The display is not receiving input power or the display is inoperable.
- I. LED for indication of network connection type:
  - Solid green: The system is connected to a network operating at 10 Megabits per second (Mbps).
  - Flashing green: The system is receiving or transmitting data packets at 10 Megabits per second (Mbps).
  - Solid orange: The system is connected to a network operating at 100 Megabits per second (Mbps).
  - Flashing orange: The system is receiving or transmitting data packets at 100 Megabits per second (Mbps).
  - Off: One or more of the following exists: The display is not receiving input power, the cable that connects the system to the network is disconnected, the device that connects the system to the network is turned off, or the display is inoperable. Check the connections and if the LED remains off, contact Schneider Electric.
- J. Slots reserved for service.

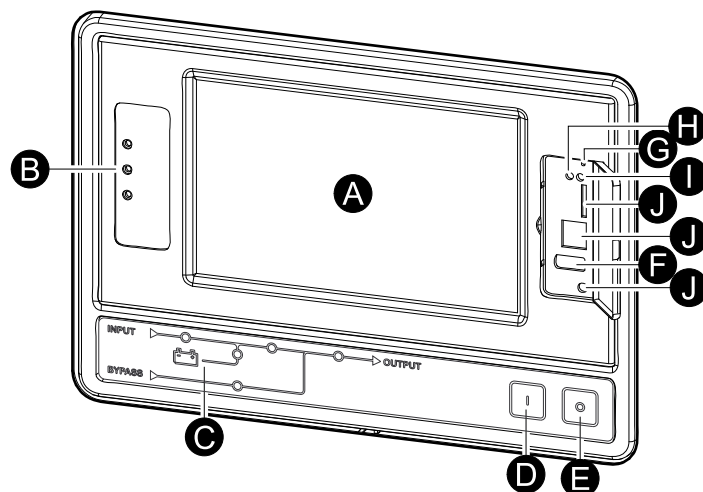

## Overview of Mimic Diagram

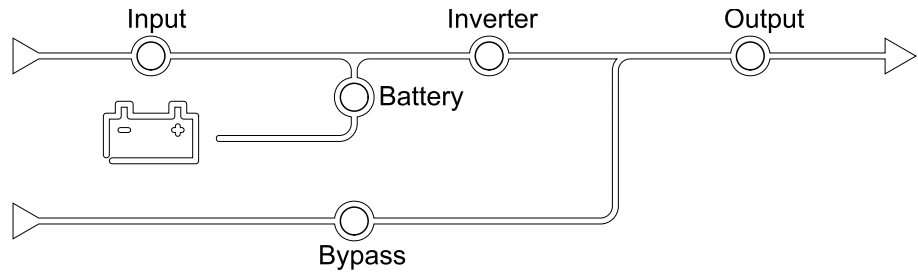

The mimic diagram shows the power flow through the UPS system, and the status of the main functions.

Each LED can be in one of the below three states:

Green	The corresponding function is active and OK	
Red	The corresponding function is not working properly	
Off	The corresponding function is not active	







## Overview of Status LEDs

The status LEDs placed next to the display interface shows the current status of the UPS system:

<ul style="list-style-type: none"> <li> </li> <li> </li> <li> </li> </ul>	<ul style="list-style-type: none"> <li>• Green: The load is protected</li> <li>• Green + Orange: The load is protected, but the system reports an alarm at warning level</li> <li>• Orange + Red: The load is unprotected and the system reports an alarm at warning level and an alarm at critical level</li> <li>• Red: The load is unprotected and the system reports an alarm at critical level</li> </ul>
---	--



## Display Symbols

Symbol	Description
	The locked home button appears when the system is locked by a password protection. Tap this button to go to the home screen of the display.
	The unlocked home button appears when the system has been unlocked using the password. Tap this button to go to the home screen of the display.
	Tap the OK button to confirm your selections and exit the current screen.
	Tap the ESC button to cancel your changes and exit the current screen.
	Tap the filter button to set up the filters for your logs.
	Tap the recycle bin button to clear the log.

# Operation Modes

The Galaxy UPS has two different levels of operation mode:

- UPS Operation Mode: The operation mode of the operated UPS. See *UPS Operation Modes, page 10*.
- System Operation Mode: The operation mode of the complete UPS system. See *System Operation Modes, page 13*.

## UPS Operation Modes

### Normal

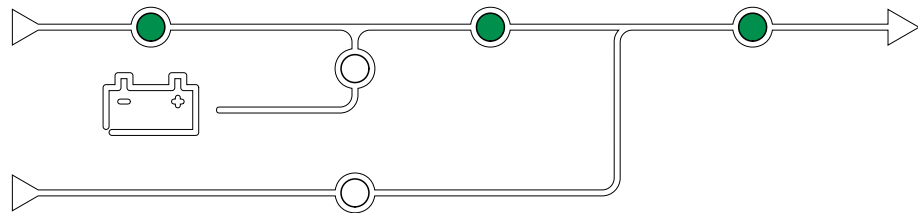

During normal operation, the UPS supports the load with conditioned power. While the UPS is in normal operation, the input, inverter, and load LEDs are green, and the battery and bypass LEDs are off.

### Battery

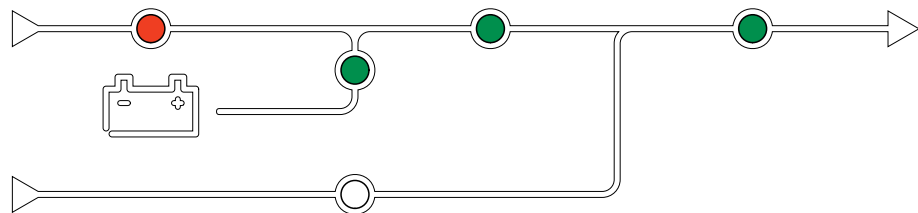

If the utility/mains supply fails, the UPS transfers to battery operation and supports the load with conditioned power from the DC source. While the UPS system is in battery operation, the battery, inverter, and load LEDs are green, the bypass LED is off and the input LED is red.

### Requested Static Bypass

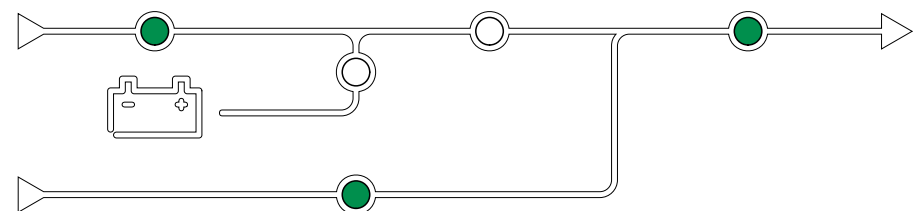

The UPS can be transferred to requested static bypass following a command from the display. During static bypass operation, the load is supplied from the bypass source. If a fault is detected, the UPS will transfer to normal operation or forced static bypass operation. If there is an interruption to the utility/mains power supply during requested static bypass operation, the system will transfer to battery operation.

During requested static bypass, the input, bypass and output LEDs are green and the battery and inverter LEDs are off.

## Forced Static Bypass

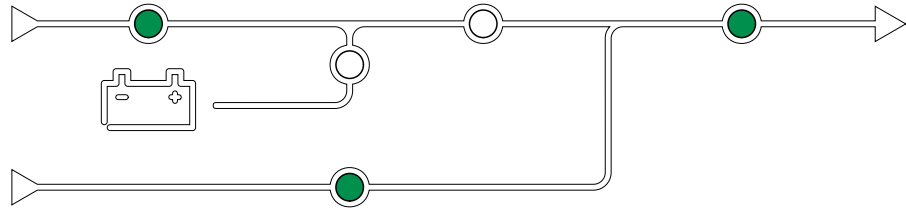

The UPS is in forced static bypass following a command from the UPS system or because the user has pressed the inverter OFF button on the UPS. During forced static bypass operation, the load is supplied directly by the bypass source.

During forced static bypass, the input, bypass and output LEDs are green and the battery and inverter LEDs are off or red if an alarm is present.

**NOTE:** The batteries are not available as an alternate power source while the UPS is in forced static bypass operation.

## Maintenance Bypass Operation

When the Maintenance Bypass Breaker (MBB) is closed, the UPS system enters maintenance bypass operation. The load is supplied with unconditioned power from the bypass input.

**NOTE:** The batteries are not available as an alternate power source while the UPS is in maintenance bypass operation.

## Static Bypass Standby

**NOTE:** Static bypass standby is only applicable to an individual UPS in a parallel system.

The UPS enters static bypass standby if the UPS is prevented from entering forced static bypass and the other UPS units of the parallel system can support the load.

In static bypass standby the output of the specific UPS is off.

The UPS automatically changes to the preferred operation mode when possible.

**NOTE:** If the other UPS units cannot support the load, the parallel system enters forced static bypass. The UPS in static bypass standby will then transfer to forced static bypass.

## Inverter Standby

**NOTE:** Inverter standby is only applicable to an individual UPS in a parallel system.

The UPS enters inverter standby if there is an interruption to the utility/mains supply of one UPS and the other UPS units of the parallel system can support the load with the configured redundancy level maintained. This is to avoid that the batteries are being drained in situations where it is not necessary.

## Battery Test

The UPS is in battery test mode when the UPS is performing a battery self-test or a runtime calibration.

**NOTE:** The battery test will be aborted if the utility/mains supply is interrupted or a critical alarm is present and will return to normal operation upon return of utility/mains.

## ECO Mode

**NOTE:** ECO mode must be enabled by a Schneider Electric field service engineer.

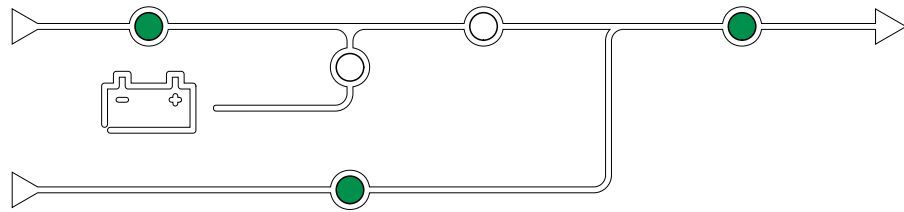

ECO mode allows the UPS to be configured to use requested static bypass, with the load supplied through the bypass, as the preferred operation mode under predefined circumstances.

If a fault is detected (bypass voltage out of tolerance, output voltage out of tolerance, etc), the UPS will immediately change to normal operation or forced static bypass.

The main advantage of ECO mode is a reduction in the consumption of electrical power.

In case of interruption to the utility/mains supply, the UPS transfers to inverter operation for a continuous supply of the load.

The batteries are charged when the UPS is in ECO mode.

**NOTE:** When changes to ECO mode settings are made on one UPS in a parallel system, the settings are shared to all UPSs in the parallel system.

## ECONversion Mode

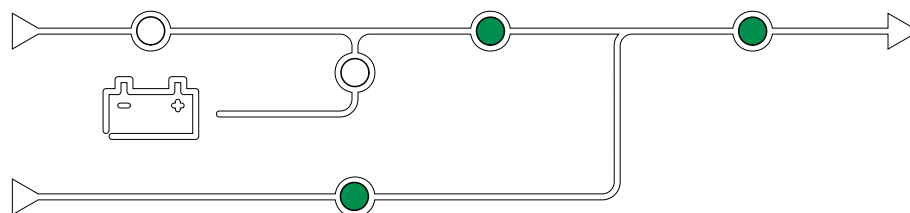

ECONversion allows the system to supply the active part of the load through the static bypass. The inverter is kept running in parallel with the bypass source and supplies the reactive part of the load.

The input power factor of the UPS is, regardless of the load power factor, maintained close to unity as the reactive part of the load is significantly reduced in the UPS input current.

In case of an interruption to the utility/mains supply, the inverter immediately maintains the output voltage so that breaks or drops during the transfer from ECONversion mode are practically eliminated.

The batteries are charged when the UPS is in ECONversion mode.

**NOTE:** When changes to ECONversion settings are made on one UPS in a parallel system, the settings are shared to all UPSs in the parallel system.

## Self-test

After start-up of the UPS system, the UPS will perform an automatic self-test. The status and progress of the self-test are indicated by the flashing LEDs on the mimic diagram.

When the self-test has been passed, the LEDs will indicate the operation mode of the UPS system.

**NOTE:** If an LED continues to flash after completion of the self-test, please call Schneider Electric.

## Off

When the UPS is in off, the UPS does not supply the connected load with power.

## System Operation Modes

The system operation mode indicates the current output status of the complete UPS system and which source that supplies the load.

## Inverter

In inverter operation the load is supplied by the inverters. The UPS mode can be in either normal or battery operation when the system operation mode is inverter operation.

## Requested Static Bypass

When the system is in requested static bypass, the load is supplied from the bypass source. If a fault is detected, the system will transfer to inverter operation or forced static bypass operation.

## Forced Static Bypass

The system is in forced static bypass following a command from the UPS system or because the user has pressed the inverter OFF button on the UPS units. During static bypass operation, the load is supplied directly by the bypass source.

**NOTE:** The batteries are not available as an alternate power source while the system is in forced static bypass operation.

## Maintenance Bypass

In maintenance bypass operation, the load is supplied by unconditioned power from the bypass input via the maintenance bypass breaker.

**NOTE:** The batteries are not available as an alternate power source in maintenance bypass operation.

## ECO Mode

**NOTE:** ECO mode must be enabled by a Schneider Electric field service engineer.

ECO Mode allows the system to be configured to use requested static bypass, with the load supplied through the bypass, as the preferred operation mode under predefined circumstances.

The main advantage of ECO mode is a reduction in the consumption of electrical power.

In case of interruption to the utility/mains supply, the UPS transfers to inverter operation for a continuous supply of the load.

## ECOversion Mode

ECOversion allows the system to supply the active part of the load through the bypass. The inverter is kept running in parallel with the bypass source and supplies the reactive part of the load.

The input power factor of the UPS is, regardless of the load power factor, maintained close to unity as the reactive part of the load is significantly reduced in the UPS input current.

In case of an interruption to the utility/mains supply, the inverter immediately maintains the output voltage so that breaks or drops during the transfer from ECO conversion mode are practically eliminated. The behaviour is the same for all UPSs in the parallel system.

## Off

When the system operation mode is off, the UPS system does not supply the connected load with power.

## Frequency Converter Mode

In frequency converter mode the UPS is able to convert the frequency of the input source to a different frequency on the UPS output.

**NOTE:** Frequency converter mode must be configured by Schneider Electric during service configuration.

The possible input/output frequencies are 50/50 Hz, 50/60 Hz, 60/50 Hz and 60/60 Hz. This is set under output frequency.

When the UPS is configured as frequency converter static bypass is not available:

- Transfer to static bypass is disabled
- Alarms and events related to the static bypass switch and the bypass source are disabled (not shown)
- References to the static bypass switch and the MBB are removed from the mimic diagram in the display and UPS Tuner
- Guided sequences are changed to support startup and shutdown of the UPS with no bypass available

It is possible to run battery self-test and battery runtime calibration even when there is no bypass available.

**NOTE:** In frequency converter mode the capacitor lifetime is reduced by 40%.

# UPS Display

## UPS Display Menu Tree

**NOTE:** The display menu tree is dependent on your system configuration. All screens might not be available on your UPS.

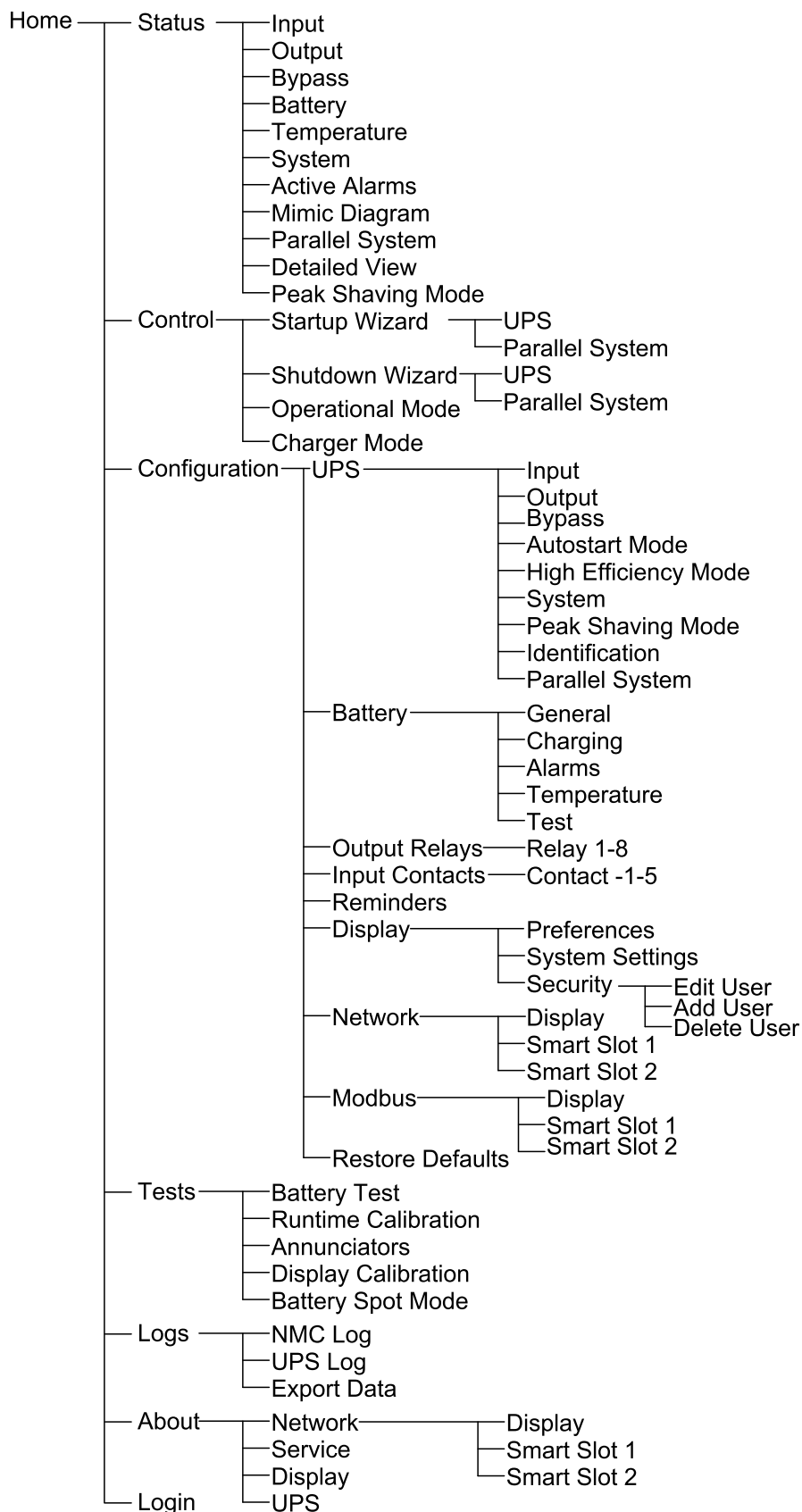

# Configuration from the UPS Display

## Disable Password Request

1. From the home screen on the display select **Configuration**.
2. Select **Disable Password Request**.

**NOTE:** When **Disable Password Request** has been enabled, it is no longer required to enter the password when configuring or operating the UPS. However when changing this setting, the password is required.

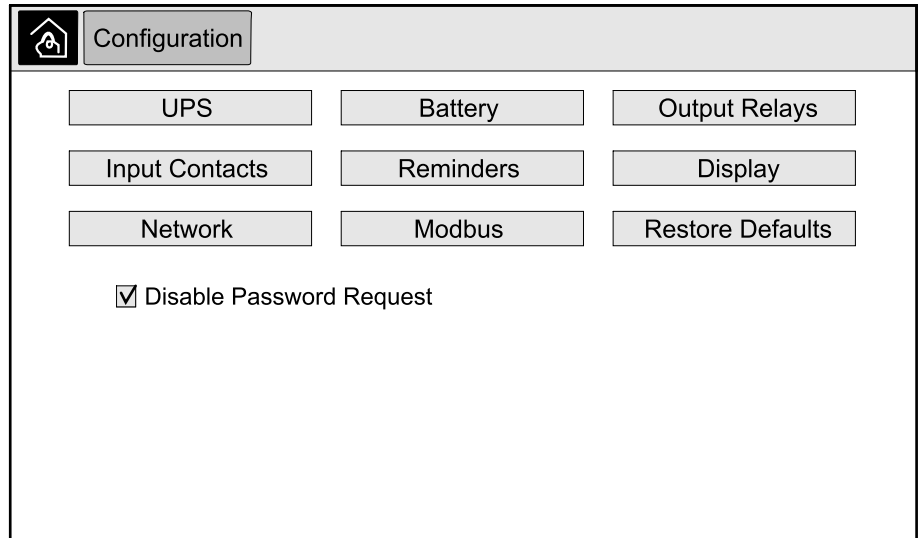

## Add a New User or Edit an Existing User

1. From the home screen on the display select **Configuration > Display > Security**.
2. Select **Add User** to add a new user or select **Edit User** to edit an existing user of the system.

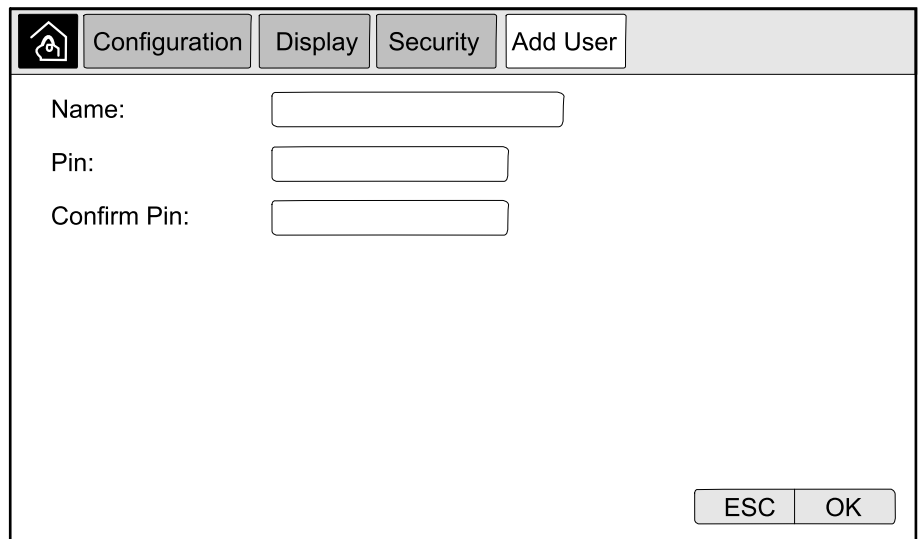

3. In the **Name** field, type in the name of the user. Complete with **Enter**.
4. In the **Pin** field, type in a pin code for the user. Complete with **Enter**.
5. In the **Confirm Pin** field, retype the pin code of the user. Complete with **Enter**.
6. Tap **OK** to save your settings.



## Delete a User

1. From the home screen on the display select **Configuration > Display > Security > Delete User**.
2. Browse to the user that you wish to delete using the up and down arrows and tap **OK**.
3. Tap **Yes** to confirm deletion of an existing user of the system.

## Configure the Display Preferences

1. From the home screen on the display select **Configuration > Display > Preferences**.

The screenshot shows the 'Preferences' screen with the following options:

- Language: English (with up/down arrows)
- Date Format: mm/dd/yyyy (with up/down arrows)
- Temperature:  US Customary  Metric
- Manual: 
  - Current Date:
  - Current Time:
- Synchronize with NTP Server:

Buttons: ESC, OK

2. Select the preferred language using the up and down arrows.
3. Select the preferred date format using the up and down arrows.
4. Select the preferred temperature units: **US Customary** (°Fahrenheit) or **Metric** (°Celsius).
5. Set the current date and time using one of the below two methods:
  - Set the date and time manually on the display by selecting **Manual** and typing the actual date and time and completing with **Enter**.
  - Set the date and time automatically by selecting **Synchronize with NTP server** (Network Time Protocol server).

**NOTE:** NTP server settings can be configured in the network management interface via the Web, command line, or config file.

6. Tap **OK** to save your settings.

## Configure the Display Settings

1. From the home screen on the display select **Configuration > Display > System Settings**.

The screenshot shows the 'System Settings' screen. At the top, there are three tabs: 'Configuration', 'Display', and 'System Settings'. Below the tabs, the following settings are visible:

- Alarm Volume: V Low ^
- Button Volume: V Medium ^
- Brightness: V High ^
- Backlight Timeout:  Enable Auto Log Off
- Backlight Timeout: V 10 ^ minutes V 1 ^ minutes
- Backlight Intensity: V Off ^ intensity

At the bottom right, there are two buttons: 'ESC' and 'OK'.

2. Set the **Alarm Volume**. Choose between: **Off, Low, Medium, and High**.
3. Set the **Button Volume**. Choose between: **Off, Low, Medium, and High**.
4. Set the **Brightness** of the display. Choose between: **Low, Medium, and High**.
5. Enable or disable **Backlight Timeout**. If you wish to enable backlight timeout, set the time limit in minutes for enabling backlight timeout. Choose between: **60, 30, 10, 5, and 1**.
6. Set the intensity of the backlight. Choose between: **Off, Very Low, Low, and Medium**.
7. Set the time limit in minutes for automatic log off. Choose between: **60, 30, 10, 5, and 1**.
8. Tap **OK** to save your settings.

## Configure the UPS Output Voltage Compensation

1. From the home screen on the display select **Configuration > UPS > Output**.
2. Tap arrow to the right to go to the next output configuration screen.

The screenshot shows the 'Output' configuration screen. At the top, there are three tabs: 'Configuration', 'UPS', and 'Output'. Below the tabs, the following settings are visible:

- Nominal Voltage (L-N)/(L-L):
- Voltage Tolerance:
- Frequency:
- Frequency Tolerance:
- Synchronization Speed:
- Transformer:
- AC Wiring Configuration:

At the bottom, there are two sets of buttons: 'ESC < 1/2 > OK' and 'ESC OK'.

- Under **Voltage Compensation** select the preferred voltage compensation for your system. Choose between **-3%**, **-2%**, **-1%**, **0%**, **1%**, **2%**, or **3%**.

**NOTE:** This setting is shared between all UPSs in a parallel system.

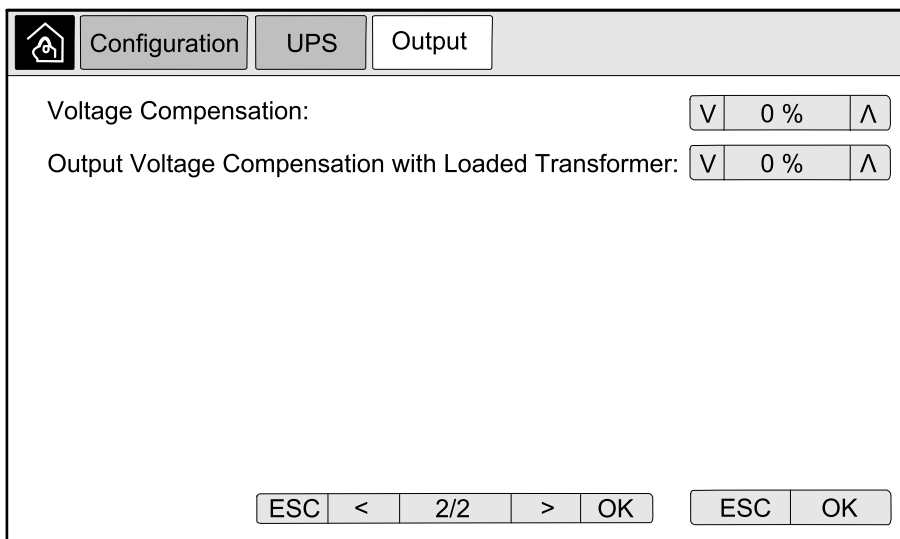

- Under **Output Voltage Compensation with Loaded Transformer** select the preferred output voltage compensation to compensate for load dependent transformer voltage drop. Choose between **0%**, **1%**, **2%**, or **3%**.

**NOTE:** This setting must be identical for all UPSs in a parallel system.

**NOTE:** When this setting is set to 0%, the output transformer voltage compensation is disabled.

- Tap **OK** to confirm your setting.

### Configure High Efficiency Mode

**NOTE:** ECO Mode must be enabled by Schneider Electric during service configuration to make this selection available.

The UPS returns to high efficiency mode after 10 seconds under normal operating conditions. If an unstable mains forces the UPS to exit high efficiency mode more than one to ten times (this setting must be configured by Schneider Electric) within 24 hours, the UPS will disable high efficiency mode. An informational alarm will be generated, and **Disabled by system** will be shown on the screen **Configuration > UPS > High Efficiency Mode**. High efficiency must then be manually reactivated.

- From the home screen on the display select **Configuration > UPS > High Efficiency Mode** and configure the following settings:

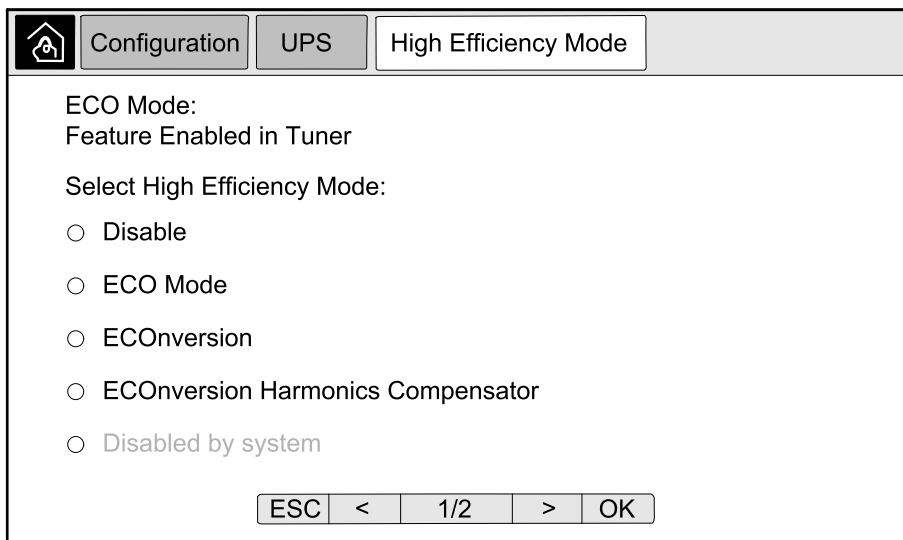

- Select High Efficiency Mode:** Choose between **Disable**, **ECO Mode**, **EConversion**, and **EConversion Harmonics Compensator**.

- Tap **>** and configure the schedule settings:

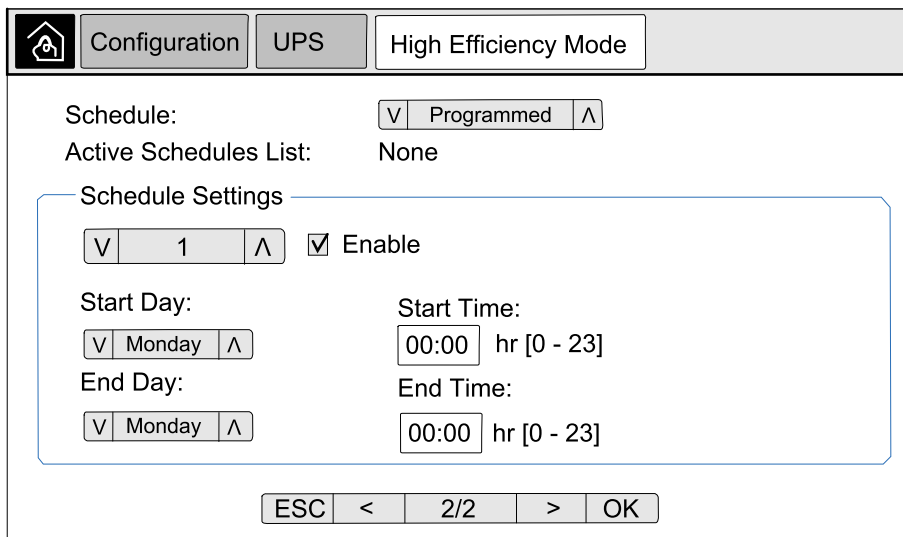

- Schedule:** Select when the system should enter the selected EConversion or ECO mode. Choose between **Always**, **Programmed** and **Never**.
- Active Schedules List:** If you chose **Programmed** above, select **Enable** and set the time and date for when the system should enter the selected EConversion or ECO mode.

- Tap **OK** to confirm your settings.

## Enable Peak Shaving Mode

Peak shaving mode allows the UPS to reduce peak power consumed from the utility/mains supply.

**NOTE:** Peak shaving mode must be enabled locally by Schneider Electric during service configuration to make this selection available, but it must be controlled via a remote software application. Contact Schneider Electric for more details.

- From the home screen on the display select **Configuration > UPS > Peak Shaving Mode**.

2. Select **Enable** to enable peak shaving mode.

Configuration   UPS   Peak Shaving Mode

Peak Shaving Mode:  Enable  
Interface: None

ESC   OK

3. Tap **OK** to confirm your settings.

## Set the UPS Identification

**NOTE: User Defined Name and User Defined Location** must be configured via the network management interface. For more information see *Access a Configured Network Management Interface, page 39*.

1. From the home screen on the display select **Configuration > UPS > Identification**.
2. Select to have the UPS identified via **Model Name, User Defined Name** or **User Defined Location**.

Configuration   UPS   Identification

Identification: Galaxy VX 1000 kVA

UPS Title:

Model Name  
 User Defined Name  
 User Defined Location

ESC   <   1/2   >   OK

3. Tap arrow to the right to go to the next configuration screen.

4. Tap the text box and type a name for the individual breakers or keep the default settings. The alias is limited to four characters.

	Configuration	UPS	Identification
<u>Breaker Identification</u>		<u>Default</u>	<u>Alias</u>
System Isolation Breaker:		SIB	XXXX
Unit Input Breaker:		UIB	XXXX
Static Switch Input Breaker:		SSIB	XXXX
Maintenance Bypass Breaker:		MBB	XXXX
Unit Output Breaker:		UOB	XXXX
Bypass Backfeed Breaker:		BF2	XXXX
Battery Breaker:		BB	XXXX
ESC < 2/2 > OK			

5. Tap **OK** to confirm your settings.

### Configure the Input Contacts

1. On the display select **Configuration > Input Contacts** and select the input contact that you wish to configure.

	Configuration	Input Contacts	Contact 1
Signal Alarm/Event when:			
V	None		^
ESC OK			

2. Choose between the below options:

<b>Custom Input 1:</b> General purpose input.	<b>External Battery Monitoring Detected Fault:</b> Input to indicate that the external battery monitor has detected a fault.
<b>Custom Input 2:</b> General purpose input.	<b>Battery Room Ventilation Inoperable:</b> Input to indicate that the battery room ventilation is inoperable. When the input is active, the battery charger will turn off.
<b>Ground fault:</b> Input to indicate that a ground fault is present.	<b>Supplied By Genset:</b> Input to indicate that the UPS is running on generator. The battery charge current will be reduced to the value set by Schneider Electric during start-up.
<b>Inhibit Transfer from Static Bypass:</b> When this input is active, and the system enters requested static bypass or forced static bypass, the system will be locked in static bypass as long as the input is active.	<b>External energy storage: minor alarm:</b> Input to indicate that the external energy storage monitor reports a minor alarm.
<b>External energy storage: major alarm:</b> Input to indicate that the external energy storage monitor reports a major alarm.	<b>Force the Charger to Turn Off:</b> Input that forces the charger to turn off.
<b>Flywheel inoperable:</b> Input to indicate that the flywheel is inoperable.	<b>Disable High Efficiency Mode:</b> Input to disable the use of high efficiency mode
<b>Request bypass operation:</b> Input that will transfer the UPS into requested static bypass operation if the conditions for a transfer are met.	<b>Force battery operation:</b> Input that will force a transfer to battery operation.

3. Tap **OK** to save your settings.

### Configure the Output Relays

1. On the display select **Configuration > Output Relays**.
2. Select to enable or disable **Energized check mode**.
  - When **Energized check mode** is enabled the output relays are ON. If a signal is received or the power supply to the relay is lost, the circuit will open and the relay will be deactivated.
  - When **Energized check mode** is disabled the output relays are OFF. If a signal is received, the circuit will close and the relay will be activated.

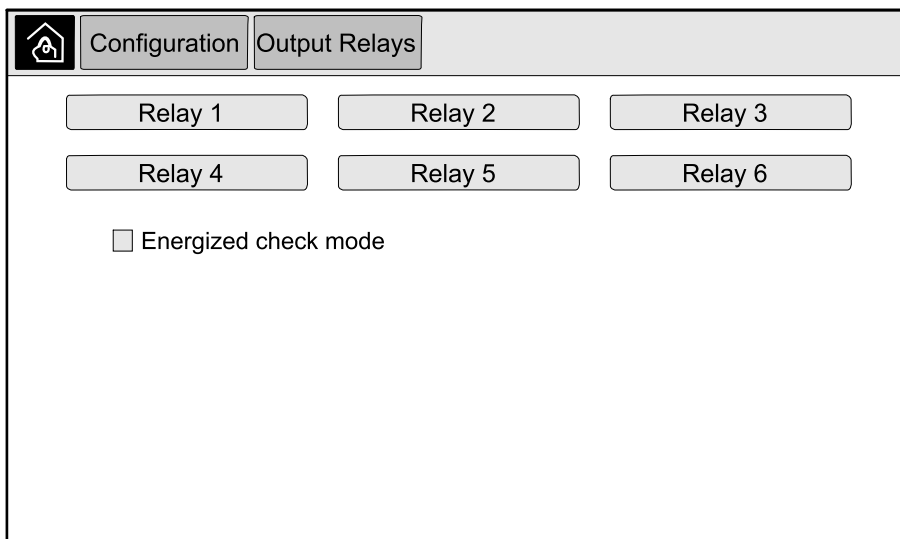

3. Select the output relay that you wish to configure.

4. Select the function that you wish to use the specific output relay for from the list below:

<b>Common Alarm:</b> The output is triggered when any alarm is present.	<b>Normal Operation:</b> The output is triggered when the UPS is running in normal operation.
<b>Battery Operation<sup>1</sup>:</b> The output is triggered when the UPS is running in battery operation.	<b>Maintenance Bypass<sup>2</sup>:</b> The output is triggered when the UPS is running in maintenance bypass operation.
<b>Static Bypass<sup>1</sup>:</b> The output is triggered when the UPS is running in forced static bypass operation or requested static bypass operation.	<b>High Efficiency Mode:</b> The output is triggered when the UPS is running in EConversion or ECO mode.
<b>Output Overload:</b> The input is triggered when there is an overload condition.	<b>Fan Inoperable:</b> The output is triggered when one or more fans are inoperable.
<b>Battery is not Working Correctly<sup>1</sup>:</b> The output is triggered when the batteries are not working correctly.	<b>Battery Disconnected<sup>1</sup>:</b> The output is triggered when the batteries have been disconnected or the battery breaker(s) are open.
<b>Battery Voltage Low<sup>1</sup>:</b> The output is triggered when the battery voltage is below the threshold.	<b>Input Out of Tolerance:</b> The output is triggered when the input is out of tolerance.
<b>Bypass Out of Tolerance<sup>2</sup>:</b> The output is triggered when the bypass is out of tolerance.	<b>UPS Warning:</b> The output is triggered when a warning alarm is present.
<b>UPS Critical:</b> The output is triggered when a critical alarm is present.	<b>Parallel Redundancy Lost:</b> The output is triggered when the specified redundancy has been lost.
<b>External Fault:</b> The output is triggered when a fault external to the UPS is present.	<b>UPS Maintenance Mode:</b> The output is triggered when the unit output breaker (UOB) is open.
<b>System Warning:</b> The output is triggered when a warning alarm is present in a parallel system.	<b>System Critical:</b> The output is triggered when a critical alarm is present in a parallel system.
<b>System Common Alarm:</b> The output is triggered when any alarm is present in a parallel system.	<b>Emergency power off activated:</b> The output is triggered when the EPO has been activated.
<b>Transfer to static bypass disabled</b>	<b>UPS informational alarm:</b> The output is triggered when an information alarm is present.
<b>System informational alarm:</b> The output is triggered when an information alarm is present in a parallel system.	

5. Set the delay in seconds for the specific output to activate. Select a value between 0 and 60 seconds.

6. Tap **OK** to save your settings.

### Configure Reminder Settings

When the air filters have been replaced, the reminders settings must be updated.

1. From the home screen on the display select **Configuration > Reminders**.

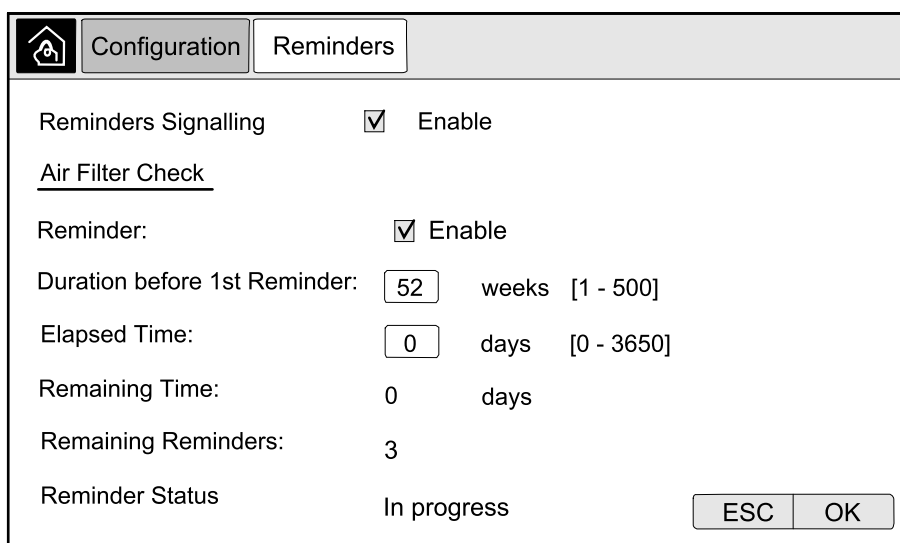

1. Not available when operating as a frequency converter without batteries.  
 2. Not available when operating as a frequency converter.



2. Configure the following settings:
  - a. **Reminders Signalling:** Select **Enable** to enable the display of all reminders.
  - b. **Reminder:** Select **Enable** to enable the display of reminders for air filter replacement.
  - c. **Duration before 1st Reminder:** Set the time in weeks before the first reminder is shown.
  - d. **Elapsed Time:** Manually set the number of days that the air filters have been used.
3. Tap **OK** to confirm your settings.

### Configure Battery Alarm Threshold

1. From the home screen on the display select **Configuration > Battery > Alarms**.

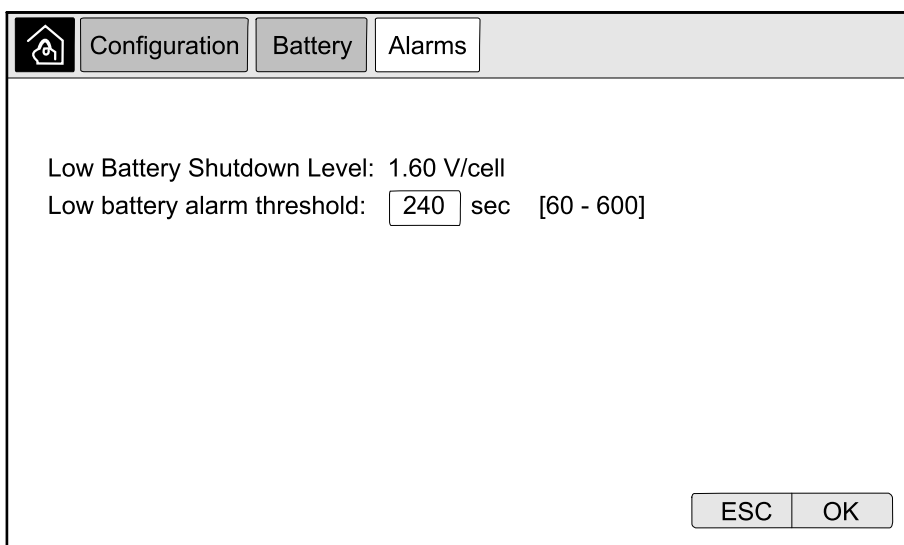

2. Select your preferred battery alarm threshold in seconds. Select a value between 60 and 6000 seconds and complete with **Enter**.
3. Tap **OK** to confirm your setting.

### Configure Automatic Battery Test

1. From the home screen on the display select **Configuration > Battery > Test**.

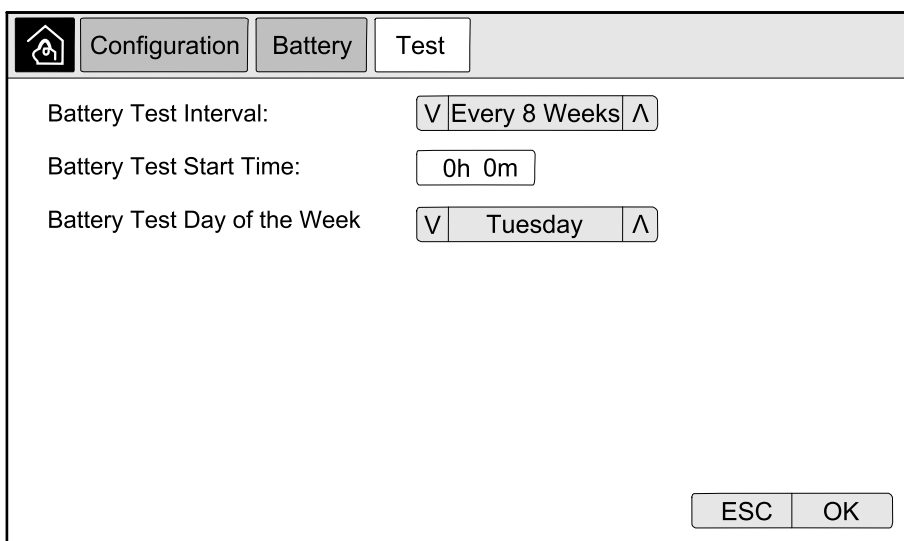

2. Set your preferred settings for the automatic battery test:
  - a. **Battery Test Interval:** Select your preferred interval for battery tests. Choose between: **Never**, **Every 52 Weeks**, **Every 26 Weeks**, **Every 12 Weeks**, **Every 8 Weeks**, **Every 4 weeks**, **Every 2 Weeks**, or **Once a Week**.

**NOTE:** If you run battery tests too frequently it can reduce the lifetime of the batteries.
  - b. **Battery Test Start Time:** Select the time of the day in 24 hour format that the test should take place and complete with **Enter**.
  - c. **Battery Test Day of the Week:** Select the day of the week that the test should take place and complete with **Enter**.
3. When all settings have been completed, tap **OK** to confirm your settings.

## Configure the Network

The network can be configured for the display and for the cards in Smart Slot 1 and Smart Slot 2.

1. From the home screen on the display select **Configuration > Network** and select either **Display**, **Smart Slot 1**, or **Smart Slot 2** if present.
2. Configure the following settings:
  - a. **TCP/IPv4: Enable IPv4** (if applicable), and select the **Address Mode (Manual, DHCP, or BOOTP)**.

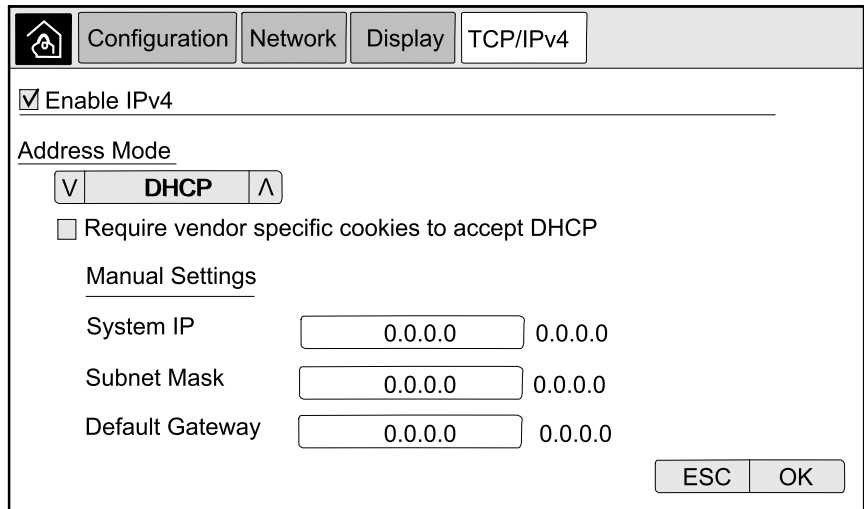

- b. **TCP/IPv6: Enable IPv6** (if applicable), select **Auto Configuration** or **Manual Configuration**, and select the **DHCPv6 Mode (Router controlled, Non-Address Information Only, Never, or Address and Other Information)**.

**NOTE:** Tap **Addresses** to see all valid IPv6 addresses.

- c. **Web Access: Enable Web** (if applicable) and select the **Access Mode (HTTP or HTTPS)**.

**NOTE:** Not available for Smart Slots.

- d. **FTP server: Enable FTP** (if applicable).

**NOTE:** Not available for Smart Slots.

## Configure the Modbus

The modbus can be configured for the display and for the cards in Smart Slot 1 and Smart Slot 2.

**NOTE:** Only the display and optional Network Management Card AP9635 can be used for serial modbus.

1. From the home screen on the display select **Configuration > Modbus** and select either **Display**, **Smart Slot 1**, or **Smart Slot 2**.
2. Configure the modbus by enabling **Serial** or **TCP** access, and adding the needed values.

The screenshot shows the Modbus configuration interface. At the top, there are three tabs: 'Configuration', 'Modbus', and 'Display'. The 'Modbus' tab is active. Below the tabs, there are two sections: 'Serial' and 'TCP'.  
 Under 'Serial':  
 - 'Access' is checked with a box containing a checkmark, followed by the text 'Enable'.  
 - 'Address' is a text input field containing '1', with '[1-247]' to its right.  
 - 'Baud Rate' is a spinner control showing '9600'.  
 - 'Parity' is a spinner control showing 'Even'.  
 Under 'TCP':  
 - 'Access' is unchecked with an empty box, followed by the text 'Enable'.  
 - 'Port' is a text input field containing '502', with '[502, 5000-32768]' to its right.  
 At the bottom right, there are two buttons: 'ESC' and 'OK'.

3. Tap **OK** to confirm your settings.

## Restore Default Configuration

1. From the home screen on the display select **Configuration > Restore Defaults**.

The screenshot shows the 'Restore Defaults' configuration screen. At the top, there are two tabs: 'Configuration' and 'Restore Defaults'. The 'Restore Defaults' tab is active. Below the tabs, there are several options:  
 - 'Restart Network Interface' with a radio button.  
 - 'Reset All' with a radio button.  
 - 'Exclude TCP/IP' with an unchecked checkbox.  
 - 'Reset Only' with a radio button.  
 Under 'Reset Only', there are three sub-options, each with an unchecked checkbox:  
 - 'TCP/IP'  
 - 'Event Configuration'  
 - 'Display Settings'  
 At the bottom right, there are two buttons: 'ESC' and 'OK'.

2. Select one of the below options:
  - **Restart Network Interface:** Select this option to restart network interface.
  - **Reset All:** Select this option to reset all settings to default. You can select to leave out the TCP/IP settings from the reset procedure.
  - **Reset Only:** Select this option if you only wish to reset parts of the settings to default values. You can select to reset the following settings: **TCP/IP**, **Event Configuration**, and **Display Settings**.

3. When you have made your selection, tap **OK** to reset the selected settings to default.

## Operation Procedures from the UPS Display

### Access Password-Protected Screens

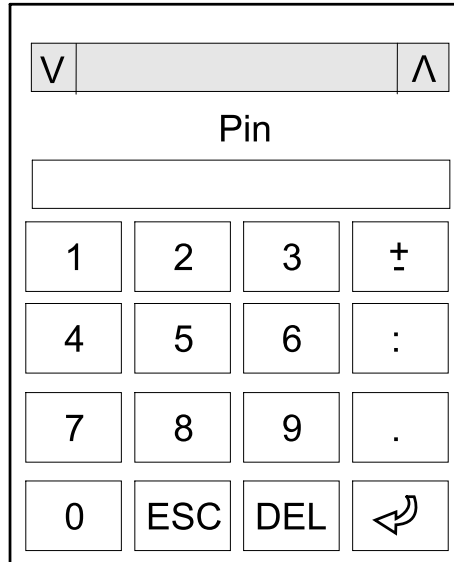

1. When prompted for the password, select your username.
2. Type in the pin code for your username.  
**NOTE:** The default pin code is 1234.
3. Change the password. For more information see *Change the User Password*, page 54.

### View the System Status Information

**NOTE:** The display does not show real time data, and a comparison between the display and an external power analyzer will not show the same data. Please allow for a tolerance of  $\pm 1\%$  for voltages,  $\pm 3\%$  for power, and  $\pm 3\%$  for currents.

1. From the home screen on the display select **Status**.

2. Select the area for which you wish to see the status. Choose between:

**Input**

<b>Voltage</b> (phase-to-neutral) <sup>3</sup>	The present phase-to-neutral input voltage in volts (V).
<b>Current</b>	The present input current from the AC utility power source per phase in amperes (A).
<b>Maximum RMS Current</b>	The maximum current for the latest 30 days.
<b>Apparent Power</b>	The present apparent power input for each phase in kVA. Apparent power is the product of RMS (root mean square) volts and RMS amperes.
<b>Active Power</b>	The present active power (or real power) input for each phase in kilowatts (kW). Active power is the portion of power flow that, averaged over a complete cycle of the AC waveform, results in net transfer of energy in one direction.
<b>Power Factor</b>	The ratio of the active power to apparent power.
<b>Voltage</b> (phase-to-phase)	The present phase-to-phase input voltage.
<b>Total Apparent Power</b>	The present total apparent power input (for all three phases) in kVA.
<b>Total Active Power</b>	The present total active power input (for all three phases) in kW.
<b>Frequency</b>	The present input frequency in hertz (Hz).
<b>Energy</b>	The total energy consumption since the time of installation or since the number was reset.

**Output**

<b>Voltage</b> (phase-to-neutral) <sup>3</sup>	The phase-to-neutral output voltage at the inverter in volts (V).
<b>Current</b>	The present output current for each phase in amperes (A).
<b>Maximum RMS Current</b>	The maximum current for the latest 30 days.
<b>Apparent Power</b>	The present apparent power output for each phase in kVA. Apparent power is the product of RMS (root mean square) volts and RMS amperes.
<b>Active Power</b>	The present active power (or real power) output for each phase in kilowatts (kW). Active power is the portion of power flow that, averaged over a complete cycle of the AC waveform, results in net transfer of energy in one direction.
<b>Power Factor</b>	The present output power factor for each phase. Power factor is the ratio of active power to apparent power.
<b>Current Crest Factor</b>	The present output crest factor for each phase. The output crest factor is the ratio of the peak value of the output current to the RMS (root mean square) value.
<b>Current THD</b>	The THD (total harmonic distortion) for each phase, as a percentage, for the present output current.
<b>Voltage</b> (phase-to-phase)	The phase-to-phase output voltage at the inverter in volts (V).
<b>Total Apparent Power</b>	The present apparent power output for each phase in thousands of Volt-Amps (kVA). Apparent power is the product of RMS (root mean square) volts and RMS amperes.
<b>Total Active Power</b>	The present total active output power (for all three phases) in kilowatts (kW).
<b>Load</b>	The percentage of the UPS capacity presently used across all phases. The load percentage for the highest phase load is displayed.
<b>Neutral Current</b> <sup>3</sup>	The present output neutral current in amperes (A).
<b>Frequency</b>	The present output frequency in hertz (Hz).
<b>Inverter Status</b>	The general condition of the inverter.
<b>PFC Status</b>	The general condition of the PFC.
<b>Energy</b>	The total energy supplied since the time of installation or since the value was reset.

**Bypass**

<b>Voltage</b> (phase-to-neutral) <sup>3</sup>	The present phase-to-neutral bypass voltage (V).
<b>Current</b>	The present bypass current for each phase, in amperes (A).

3. Only applicable in systems with neutral connection.

**Bypass (Continued)**

<b>Maximum RMS Current</b>	The maximum current for the latest 30 days.
<b>Apparent Power</b>	The present apparent bypass power for each phase in kVA. Apparent power is the product of RMS (root mean square) volts and RMS amperes.
<b>Active Power</b>	The present active bypass power for each phase in kilowatts (kW). Active power is the time average of the instantaneous product of voltage and current.
<b>Power Factor</b>	The present bypass power factor for each phase. Power factor is the ratio of active power to apparent power.
<b>Voltage (phase-to-phase)</b>	The present phase-to-phase bypass voltage (V).
<b>Total Apparent Power</b>	The present total apparent bypass power (for all three phases) in thousands of Volt-Amps (kVA).
<b>Total Active Power</b>	The present total active bypass power (for all three phases) in kilowatts (kW).
<b>Frequency</b>	The present bypass frequency in hertz (Hz).

**Battery**

<b>Voltage</b>	The present battery voltage.
<b>Current</b>	The present battery current in amperes (A). A positive current indicates that the battery is charging; a negative current indicates that the battery is discharging.
<b>Power</b>	The present DC power being drawn from the battery, in kilowatts (kW).
<b>Estimated Charge Level</b>	The present battery charge, as a percentage of full charge capacity.
<b>Estimated Charge Time</b>	The estimated time, in minutes, until the batteries reach 100% charge.
<b>Runtime Remaining</b>	The amount of time in hours and minutes before the batteries reach the low-voltage shutdown level.
<b>Charger Mode</b>	The operation mode of the charger (Off, Float, Boost, Equalization, Cyclic, Test).
<b>Battery Status</b>	The general condition of the battery.
<b>Charger Status</b>	The general condition of the charger.
<b>Total Battery Capacity</b>	The total capacity available from the available batteries.
<b>Temperature</b>	The highest battery temperature from the connected temperature sensors.

**Temperature**

<b>Ambient Temperature</b>	Ambient temperature in degrees Celsius or Fahrenheit for the I/O cabinet and each power cabinet.
----------------------------	--

**System**

<b>Output Voltage</b>	The phase-to-phase output voltage at the inverter in volts (V).
<b>Output Current</b>	The present output current for each phase in amperes (A).
<b>Output Frequency</b>	The present output frequency in hertz (Hz).
<b>Runtime Remaining</b>	The amount of time in hours and minutes before the batteries reach the low-voltage shutdown level.
<b>System Time</b>	The time of the UPS system.
<b>UPS Operation Mode</b>	The operation mode of the operated UPS.
<b>System Operation Mode</b>	The operation mode of the complete UPS system.
<b>Total Output Power</b>	The apparent and active power (or real power) output for each phase.

**System (Continued)**

<b>Overload Timer<sup>4</sup></b>	The time in seconds before the UPS changes to forced static bypass due to an overload condition on the system. <b>NOTE:</b> The system can be in an overload condition even though the <b>Total Output Power</b> is below 100% if the load is not equally shared between the three phases.
<b>Output Power</b>	The phase-to-phase apparent and active power (or real power) output for each phase.

**Parallel System**

<b>Input Current</b>	The present phase-to-phase input current in amperes (A).
<b>Output Current</b>	The present phase-to-phase output current in amperes (A).
<b>Bypass Current</b>	The present phase-to-phase bypass current in amperes (A).
<b>Parallel UPS Number</b>	The parallel UPS number of the operated UPS.
<b>Parallel system redundancy</b>	The redundancy for the parallel system.
<b>Number of Parallel Units</b>	The total number of UPSs in the parallel system.
<b>Parallel Units</b>	The numbers of all UPSs in the parallel system.
<b>Output Total Apparent Power</b>	The present total apparent output power (for all three phases) in thousands of Volt-Amps (kVA).
<b>Output Total Load</b>	The percentage of the UPS system capacity presently used across all phases. The load percentage for the highest phase load is displayed.

**Active Alarms**

<b>Active Alarms</b>	For more information on active alarms, go to <i>View the Active Alarms, page 44</i> .
----------------------	---

**Mimic Diagram**

<b>Mimic Diagram</b>	The mimic diagram shows the current status of the main parts of the UPS system: power sources, converters, bypass static switch and breakers, and it shows the power flow through the system.
----------------------	---

**Detailed View**

<b>Detailed view</b>	The detailed view shows the system with a status icon on each individual power cabinet and the actual number of redundant power cabinets. The detailed view also shows the apparent power and active power per phase.
----------------------	---

Status
Detailed View

✓
1

✓
2

✓
3

✓
4

✓
5

✓
6

✓
7

Maximum available power at N+1 redundancy: 1500 kW





Redundant Power Cabinets: 1

	L1	L2	L3	
Apparent Power	xxxx	xxxx	xxxx	kVA
Active Power	xxxx	xxxx	xxxx	kW

4. The overload timer is only visible when it is active.



### Symbols on the Detailed View Screen

	Indicates that the power cabinet is operational and working correctly
	Indicates that there is an informational alarm.
	Indicates that the power cabinet redundancy has been lost and/or an alarm of severity level <b>Warning</b> is present in the power cabinet. The power cabinet is still operational.
	Indicates that the power cabinet is inoperable due to a critical event. The customer alarm <b>Power cabinet inoperable</b> is also displayed.

### Peak Shaving Mode

<b>Peak shaving mode</b>	The status of the peak shaving mode — <b>Active</b> or <b>Inactive</b>
<b>Input power</b>	The present input power (kW).
<b>Battery power</b>	The present battery power (kW). The bar is green when the batteries are charging and yellow when the batteries are discharging.
<b>Peak shaving</b>	Indicates if the charger is <b>enabled</b> or <b>disabled</b> and if forced battery operation is <b>enabled</b> or <b>disabled</b> .
<b>State of charge</b>	The current charge status of the batteries.
<b>Remaining time</b>	The remaining time in battery operation and peak shaving mode.

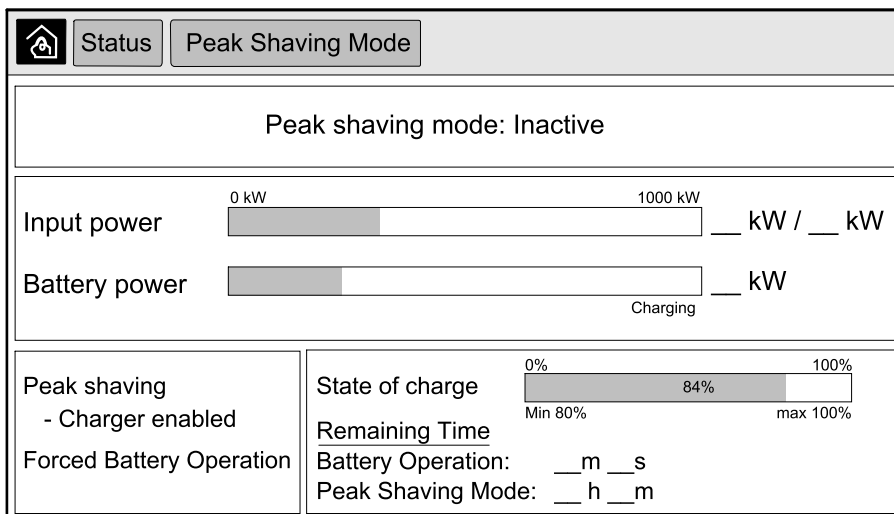

3. Tap the home button to exit the screens and return to the home screen.

### Start Up Single System from Maintenance Bypass Operation

Use this procedure to start up a single system from maintenance bypass operation with the load supplied through the MBB and all other breakers open.

**NOTE:** Only operate a breaker when the associated breaker LED is green.

1. Close the unit input breaker UIB.  
This will power up the display interface after approximately 30 seconds.
2. From the home screen on the display, select **Control > Startup Wizard**. Select **Startup from Maintenance Bypass** and follow the steps which appear on the screen.

The following is a generic start-up procedure. Always follow the steps of the **Startup Wizard** which are specific to your system.

3. Close the static switch input breaker SSIB.
4. Close the backfeed protection switch (BF2) if it is open.
5. Close the battery breakers in your specific battery solution.
6. Initiate transfer to static bypass by tapping the **Transfer Load to static bypass** button on the display interface.  
In systems with kirk-keys, the key is released from the solenoid key release unit.  
  
If the UPS system does not transfer to requested static bypass, go to **Status > Active Alarms** to see if there are active alarms that prevent the UPS system from transferring to static bypass.
7. In systems with kirk-keys, insert the key in the lock on the unit output breaker UOB and turn to unlock.
8. Close the unit output breaker UOB.
9. Open the maintenance bypass breaker MBB.  
The system automatically transfers to normal operation.
10. In systems with kirk-keys, turn the key in the lock of the maintenance bypass breaker MBB to lock open.  
The key is released.
11. In systems with kirk-keys, insert the key in the solenoid key release unit and turn to capture the key.

## Shut Down Single System from Normal to Maintenance Bypass Operation

Use this procedure to shut down a single system to maintenance bypass operation with the load supplied through the MBB.

**NOTE:** Only operate a breaker when the associated breaker LED is green.

1. From the home screen on the display, select **Control > Shutdown Wizard**. Select **Shutdown ending in Maintenance Bypass** and follow the steps which appear on the screen.  
  
**NOTE:** The following is a generic shutdown procedure. Always follow the steps of the **Shutdown Wizard** which are specific to your system.
2. Initiate transfer to static bypass by tapping the **Transfer Load to static bypass** button on the display interface.  
In systems with kirk-keys, the key is released from the solenoid key release unit.  
  
If the UPS system does not transfer to requested static bypass, go to **Status > Active Alarms** to see if there are active alarms that prevent the UPS system from transferring to static bypass.
3. In systems with kirk-keys, insert the key in the lock on the maintenance bypass breaker MBB and turn to unlock.
4. Close the maintenance bypass breaker MBB.  
In systems with kirk-keys, the key is held in the lock.
5. Open the unit output breaker UOB.
6. In systems with kirk-keys, turn the key in the lock on the unit output breaker UOB to lock open.  
The key is released.
7. In systems with kirk-keys, insert the key in the solenoid key release unit and turn to capture the key.
8. Open the static switch input breaker SSIB.

9. Initiate transfer to forced static bypass by tapping the Inverter OFF button on the front of the UPS system.
10. Open the battery breakers in your specific battery solution.
11. Open the unit input breaker UIB.

### Transfer UPS from Normal to Requested Static Bypass Operation

1. From the home screen on the display select **Control > Operational Mode**.

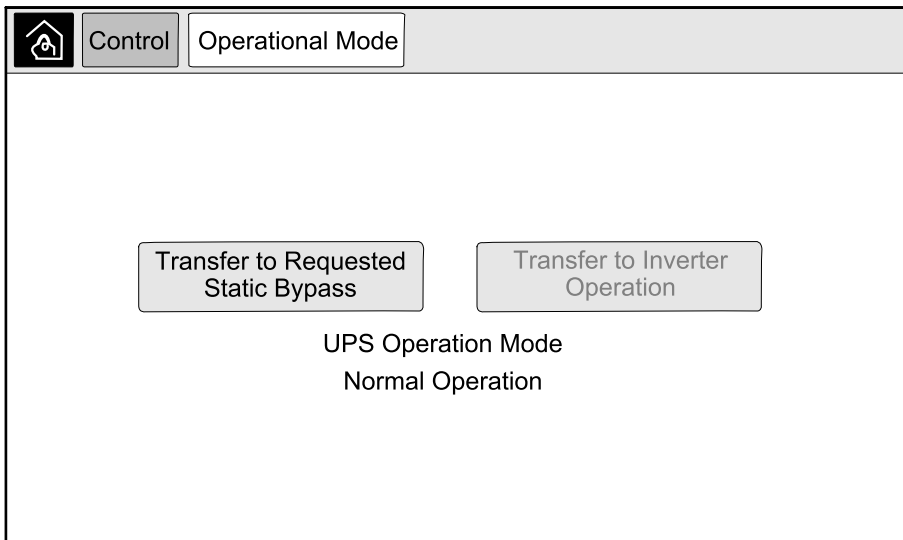

2. Tap the **Transfer to Requested Static Bypass** button.  
**NOTE:** If the conditions for performing a transfer are not met, the button will be grayed out.
3. Verify that the **UPS Operation Mode** changes to **Requested Static Bypass**.

### Transfer UPS from Requested Static Bypass Operation to Normal Operation

1. From the home screen on the display select **Control > Operational Mode**.

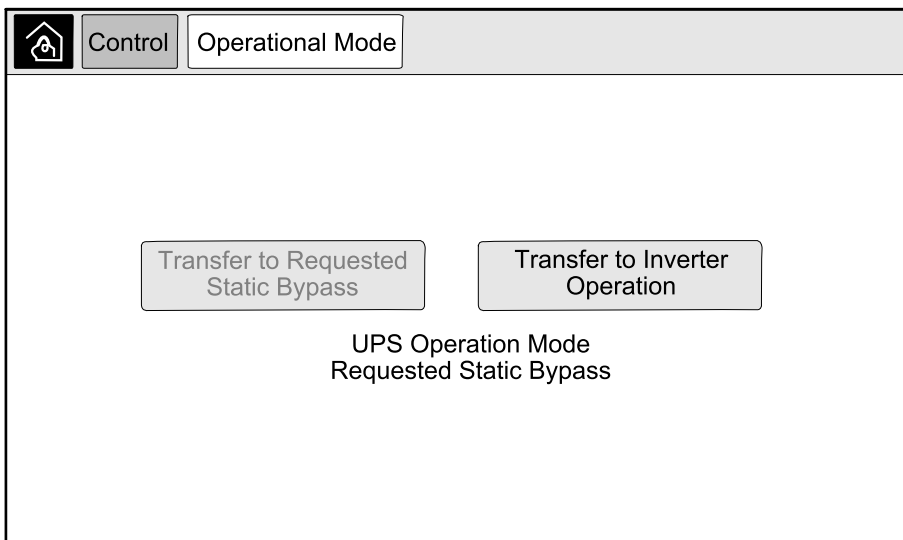

2. Tap the **Transfer to Inverter Operation** button.  
**NOTE:** If the conditions for performing a transfer are not met, the button will be grayed out.
3. Verify that the **UPS Operation Mode** changes to **Normal Operation**.

## Start Up Parallel System from Maintenance Bypass Operation

Use this procedure to start up a parallel system from maintenance bypass operation with the load supplied through the MBB and all other breakers open.

**NOTE:** Only operate a breaker when the associated breaker LED is green.

1. Close the unit input breaker UIB.  
This will power up the display interface after approximately 30 seconds.
2. From the home screen on the display, select **Control > Startup Wizard**. Select **Startup from Maintenance Bypass** and follow the steps which appear on the screen.

**NOTE:** The following is a generic start-up procedure. Always follow the steps of the **Startup Wizard** which are specific to your system.

3. Close the static switch input breaker SSIB.
4. Close the backfeed protection switch (BF2) if it is open.
5. Close the battery breakers in your specific battery solution.
6. Initiate transfer to static bypass by tapping the **Transfer Load to static bypass** button on the display interface.

In systems with kirk-keys, the key is released from the solenoid key release unit.

If the UPS system does not transfer to static bypass, go to **Status > Active Alarms** to see if there are active alarms that prevent the UPS system from transferring to static bypass.

7. Close the unit output breaker UOB.
8. Repeat steps 1 to 7 for the remaining UPS units in the parallel system before continuing.
9. In systems with kirk-keys, insert the key from the solenoid key release unit in the lock on the system isolation breaker SIB and turn to unlock.
10. Close the system isolation breaker SIB.
11. Open the maintenance bypass breaker MBB.  
The system automatically transfers to normal operation.
12. In systems with kirk-keys, turn the key in the lock of the maintenance bypass breaker MBB to lock open.  
The key is released.
13. In systems with kirk-keys, insert the key in the solenoid key release unit and turn to capture the key.

## Shut Down Parallel System from Normal to Maintenance Bypass Operation

Use this procedure to shut down a parallel system to maintenance bypass operation with the load supplied through the MBB.

**NOTE:** Only operate a breaker when the associated breaker LED is green.

1. From the home screen on the display, select **Control > Shutdown Wizard**. Select **Shutdown ending in Maintenance Bypass** and follow the steps which appear on the screen.

**NOTE:** The following is a generic shutdown procedure. Always follow the steps of the **Shutdown Wizard** which are specific to your system.

2. Initiate transfer to static bypass by tapping the **Transfer Load to static bypass** button on the display interface.  
In systems with kirk-keys, the key is released from the solenoid key release unit in the system bypass cabinet.  
  
If the UPS system does not transfer to requested static bypass, go to **Status > Active Alarms** to see if there are active alarms that prevent the UPS system from transferring to static bypass.
3. Close the maintenance bypass breaker MBB.  
In systems with kirk-keys, the key is held in the lock.
4. Open the system isolation breaker SIB.
5. In systems with kirk-keys, turn the key in the lock on the system isolation breaker SIB to lock open.  
The key is released.
6. In systems with kirk-keys, insert the key in the solenoid key release unit and turn to capture the key.
7. Perform the following steps for each UPS unit in the parallel system:
  - a. Open the unit output breaker UOB.
  - b. Open the static switch input breaker SSIB.
  - c. Initiate transfer to forced static bypass by tapping the Inverter OFF button on the front of the UPS system.
  - d. Open the battery breakers in your specific battery solution.
  - e. Open the unit input breaker UIB.

## Start Up and Add UPS to a Running Parallel System

Use this procedure to start up a UPS and add it to a running parallel system.

**NOTE:** Only operate a breaker when the associated breaker LED is green.

1. Close the unit input breaker UIB.  
This will power up the display interface after approximately 30 seconds.
2. From the home screen on the display, select **Control > Startup Wizard**. Select **Startup UPS into a parallel system** and follow the steps which appear on the screen.  
**NOTE:** The following is a generic start-up procedure. Always follow the steps of the Startup Wizard which are specific to your system.
3. Close the static switch input breaker SSIB.
4. Close the backfeed protection switch (BF2) if it is open.
5. Close the battery breakers in your specific battery solution.
6. Close the unit output breaker UOB.
7. Turn the inverter on by tapping the Inverter ON button on the front of the UPS.

## Isolate this Single UPS from the Parallel System

Use this procedure to shut down one UPS in a running parallel system.

**NOTE:** Before initiating this procedure, ensure that the remaining UPS units can supply the load.

**NOTE:** Only operate a breaker when the associated breaker LED is green.

1. From the home screen on the display, select **Control > Shutdown Wizard**. Select **Shut down UPS in a parallel system** and follow the steps which appear on the screen.

**NOTE:** The following is a generic shutdown procedure. Always follow the steps of the Shutdown Wizard which are specific to your system.

2. Turn off the UPS by pressing the Inverter OFF key on the front of the UPS.
3. Open the unit output breaker UOB.
4. Open the static switch input breaker SSIB.
5. Open the battery breakers in your specific battery solution.
6. Open the unit input breaker UIB.

## Start-Up System Operating as Frequency Converters

Use this procedure to start up a single system, a parallel system working as frequency converters, or to start up a single frequency converter and add it into a running parallel system working as frequency converters.

**NOTE:** Only operate a breaker when the associated breaker LED is green.

1. Close the unit input breaker UIB.  
This will power up the display interface after approximately 30 seconds.
2. From the home screen on the display, select **Control > Startup Wizard**. Select **Startup from Off Operation** and follow the steps which appear on the screen.

**NOTE:** The following is a generic startup procedure. Always follow the steps of the **Startup Wizard** which are specific to your system.

3. Close the battery breakers (if present).
4. Close the unit output breaker UOB.
5. Close the system isolation breaker SIB.
6. Tap **Turn Inverter On** on the display interface.

## Shut Down System Operating as Frequency Converters

Use this procedure to shut down a single system, a parallel system operating as frequency converters.

**NOTE:** Only operate a breaker when the associated breaker LED is green.

1. From the home screen on the display, select **Control > Shutdown Wizard**. Select **Shutdown ending in Off Operation** and follow the steps which appear on the screen.

**NOTE:** The following is a generic shutdown procedure. Always follow the steps of the **Shutdown Wizard** which are specific to your system.

2. Open the unit output breaker UOB.
3. Open battery breakers (if present).
4. Open the unit input breaker UIB.
5. Repeat steps 1 to 4 on each Galaxy VX in the parallel system.
6. Open the system isolation breaker (if present).

## Start a Boost Charge of the Batteries

Boost charge gives the possibility of doing a fast recharge of a discharged battery.

**NOTE:** Boost charge must be enabled by Schneider Electric during start-up for this option to be available.

1. From the home screen on the display select **Control > Charger Mode**.

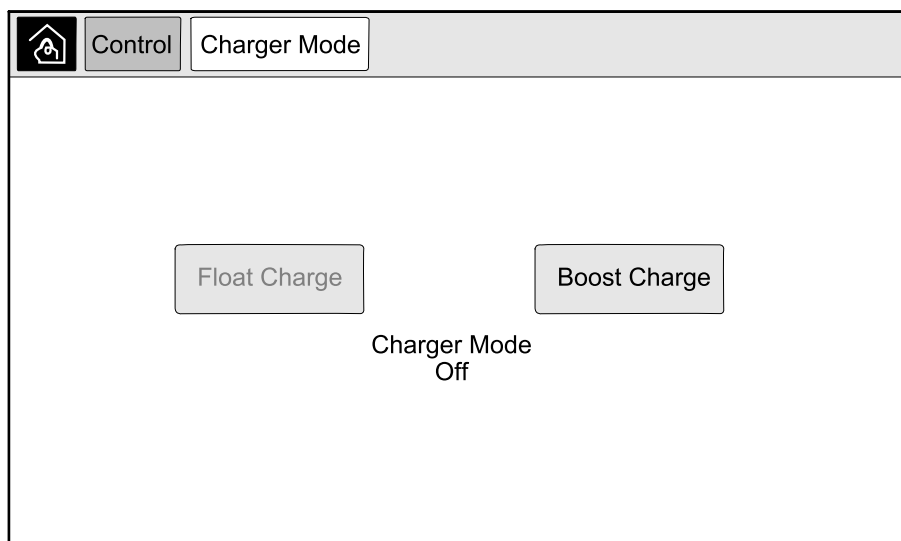

2. Select **Boost Charge** to initiate a single boost charge of the batteries. The UPS system starts boost charging the batteries. To stop the boost charge and go back to float charge, select **Float Charge**.

## Access a Configured Network Management Interface

The below procedure describes how to access the network management interface from a web interface. It is also possible to use the following interfaces:

- Telnet and SSH
- SNMP
- FTP
- SCP

**NOTE:** Ensure that only one network management interface in the entire system is set to synchronize time.

Use Microsoft Internet Explorer® 7.x or higher on Windows operating systems only or Mozilla® Firefox® 3.0.6 or higher on all operating systems to access the web interface of the network management interface. Other commonly available browsers may work but have not been fully tested.

You can use either of the following protocols when you use the web interface:

- The HTTP protocol, which provides authentication by user name and Pin but no encryption.
- The HTTPS protocol, which provides extra security through Secure Socket Layer (SSL); encrypts user names, Pin, and data being transmitted; and authenticates Network Management Cards by means of digital certificates.

1. Access the network management interface by its IP address (or its DNS name, if a DNS name is configured).
2. Enter the user name and password.
3. To enable or disable the HTTP or HTTPS protocol, use the **Network** menu on the **Administration** tab, and select the **Access** option under the **Web** heading on the left navigation menu.

# Troubleshooting from the UPS

## Troubleshooting via the Mimic Diagram LEDs

The mimic diagram shows the status of the main functions and the energy flow supplying the load. The different LEDs are either green, red or turned off depending on the status of the system functions. In this section it is listed what a red LED on the mimic diagram is indicating to help troubleshooting.

### Input LED

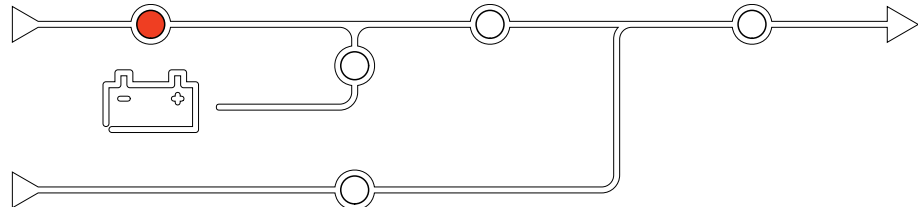

If the input LED is red, it can be caused by the following:

- UIB is open
- Input out of tolerance (waveform-, voltage-, or frequency out of tolerance)

### Inverter LED

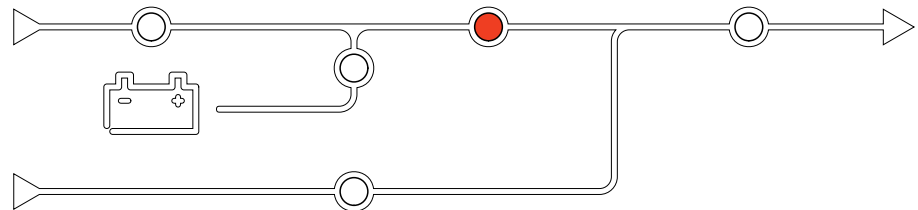

If the inverter LED is red, it can be caused by the following:

- Inverter inoperable

### Load LED

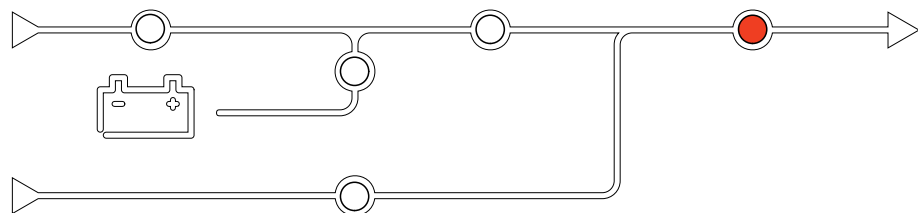

If the load LED is red, it can be caused by the following:

- UOB is open
- SIB is open
- Output voltage out of tolerance

### Battery LED

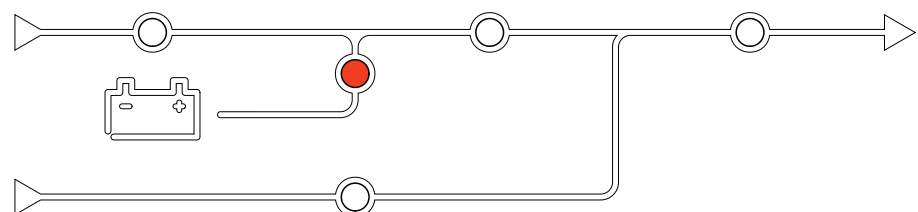



If the Battery LED is red, it can be caused by the following:

- Critical battery alarm active
- Charger inoperable
- Battery breaker disconnected

### Bypass LED

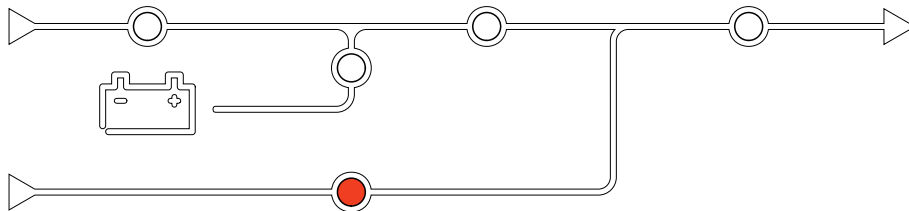

If the bypass LED is red, it can be caused by the following:

- SSIB is open
- Static bypass switch inoperable
- Bypass out of tolerance
- BF2 is open

### Reboot the Display

**NOTE:** A reboot of the display does not impact the settings made.

1. Open the shutter door on the front right side of the display.
2. Press the reboot button with a pointed object like a pen or a paper clip.

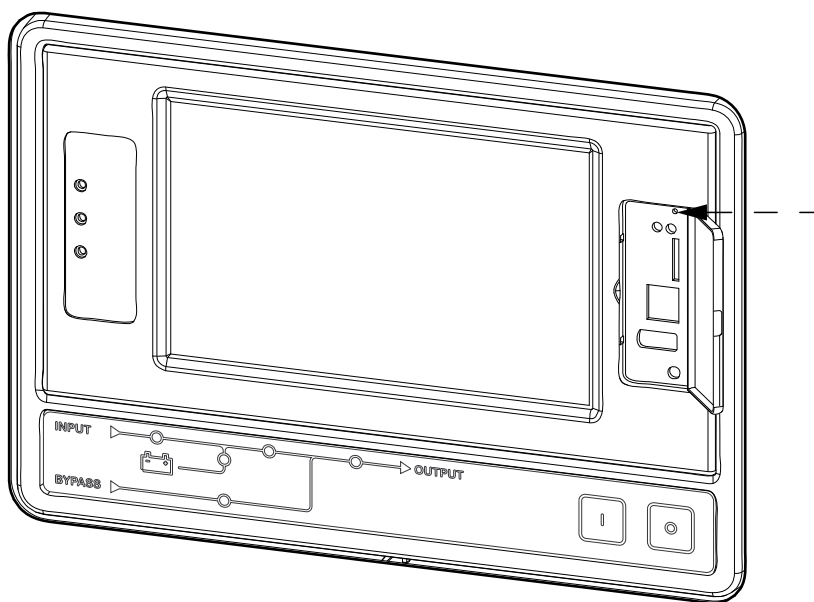

The display is rebooted.

### Logs

There are two types of logs:

- NMC Log: Contains information about the display and network activities.
- UPS Log: Contains information about the system status and operation modes.

### View the NMC Log

1. From the home screen on the display select **Logs > NMC Log**.
2. You can browse through the list of the events using the arrows.

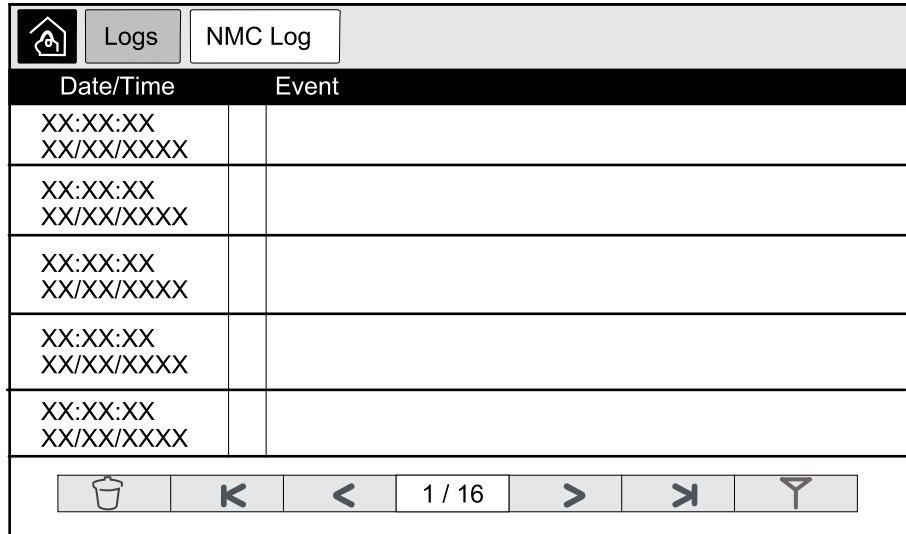

3. You can now perform the following operations in the event log:
  - a. Tap the filter button to filter the events. Different filter settings are available, including:

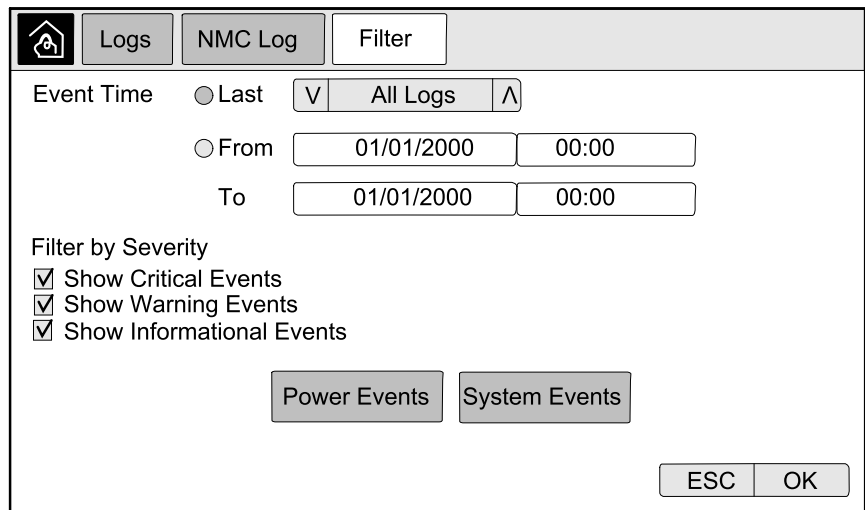

Filters for **Power Events**: **Communication, Device, Output, Input, Battery, UPS Operation Mode, Parallel System, Reminders, Switchgear, and/or RFC 1628 MIB.**

Filters for **System Events**: **Mass Configuration and/or Security.**

- b. Tap the recycle bin button to clear the event log and select **Yes** to confirm.
4. Tap the home button to exit the log.

## View the UPS Log

1. From the home screen on the display select **Logs > UPS Log**.

Date/Time		Event	
XX:XX:XX	XX/XX/XXXX		
XX:XX:XX	XX/XX/XXXX		
XX:XX:XX	XX/XX/XXXX		
XX:XX:XX	XX/XX/XXXX		
XX:XX:XX	XX/XX/XXXX		

Refresh [Recycle Bin] [Home] [Left Arrow] [Right Arrow] 1 / 16 [Next Arrow] [Filter]

2. You can now browse through the list of the UPS events using the arrows.
3. You can perform the following operations in the UPS log:
  - a. Tap the filter button to filter the events. Different filter settings are available, including:  
**Filters for Power Events: Communication, Device, Output, Input, Battery, UPS Operation Mode, Parallel System, Reminders, Switchgear, and/or RFC 1628 MIB.**  
  
**Filters for System events: Mass Configuration and/or Security.**
  - b. Tap the recycle bin button to clear the UPS log and select **Yes** to confirm.
4. Tap the home button to exit the log.

## Export Data from Logs

The exported log can only be used by Schneider Electric customer support for analysis.

1. From the home screen on the display select **Logs > Export Data**.
2. Insert a USB device in the USB port located on the front of the display.

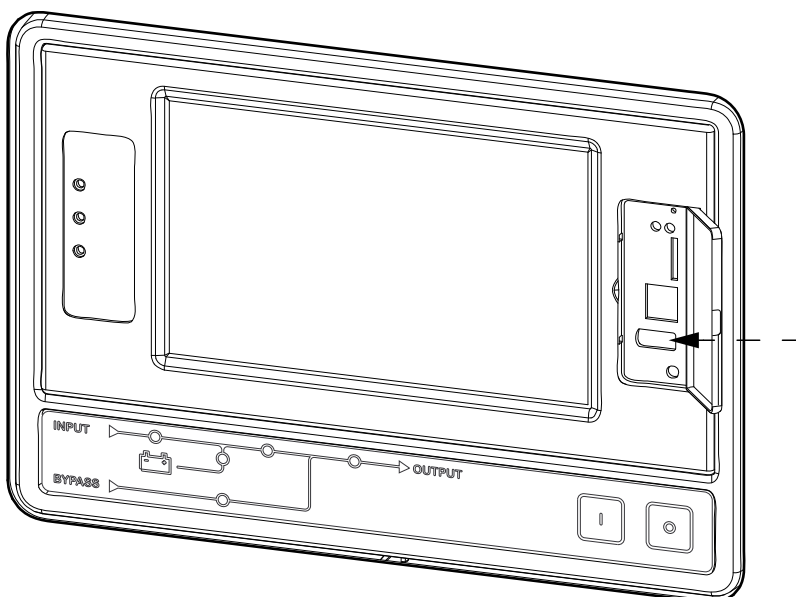

3. Tap the **Start Data Export** button.  
When the download is complete, the following message will be shown on the screen: **Data Exported Successfully. Remove USB device.**
4. Remove the USB device and tap the home button to exit the screen.
5. The exported data on the USB device can now be sent to Schneider Electric support for analyzing.

### View the Active Alarms

When there is an active alarm in the system, a symbol indicating the alarm level is shown in the top right corner of the screen and the buzzer is active.

1. From the home screen on the display select **Status > Active Alarms**.  
Tapping the display will also silence the buzzer temporarily without login. By logging in and tapping the display, the buzzer will be silenced permanently.
2. You can now browse through the list of active alarms using the left and right arrows.
3. Tap the **Refresh** button to update the list with the latest active alarms.

### Alarm Levels

There are three alarm levels:

- Critical: Take immediate action and call Schneider Electric.
- Warning: The load remains supported, but action must be taken. Call Schneider Electric.
- Informational: No immediate action required. Check the cause of the alarm as soon as possible.

### Alarm Messages

Alarm/Event	Severity	Display Text	Description	Corrective Action Text
Alarm	Warning	Abnormal state at input contact zone A	An abnormal state exists for integrated Environmental Monitor input contact zone A.	Please check the environment
Alarm	Warning	Abnormal state at input contact zone B	An abnormal state exists for integrated Environmental Monitor input contact zone B.	Please check the environment
Alarm	Warning	Air Filter technical check recommended	The air filters need to be checked as preventive maintenance is recommended.	The Air Filters may need to be replaced.
Alarm	Warning	Ambient temperature high	Ambient temperature is high.	
Alarm	Warning	Ambient temperature out of tolerance	The ambient temperature out of tolerance.	
Alarm	Warning	Batteries are discharging	The load is drawing more power than the UPS can draw from the input, causing the UPS to draw power from the batteries.	
Alarm	Warning	Battery breaker BB1 open	Battery breaker BB1 is open.	
Alarm	Warning	Battery breaker BB2 open	Battery breaker BB2 is open.	
Alarm	Warning	Battery breaker BB3 open	Battery breaker BB3 open.	
Alarm	Warning	Battery breaker BB4 open	Battery breaker BB4 open.	
Alarm	Warning	Battery capacity is below minimum acceptable level	The battery capacity is below the minimum acceptable value according to UPS power rating. Risk of battery damage.	Change battery configuration and/or add larger capacity battery

Alarm/Event	Severity	Display Text	Description	Corrective Action Text
Event	Informational	Battery breakers tripped	To prevent the batteries deep discharging, the battery breakers have been tripped by the system.	Close the battery breakers manually.
Alarm	Warning	Battery condition is poor	Battery capacity is lower than 50%.	Batteries should be replaced.
Alarm	Warning	Battery condition is weak	Battery capacity is between 50% to 75%.	
Alarm	Warning	Battery is below minimum acceptable runtime	The battery runtime is below configured minimum acceptable value.	
Alarm	Critical	Battery is not working correctly	A battery is not working correctly.	Please contact Schneider Electric.
Alarm	Warning	Battery room ventilation inoperable	Input relay indicates that the battery room ventilation is not working correctly.	
Alarm	Warning	Bypass backfeed breaker (BF2) open	Bypass backfeed breaker (BF2) is open, and the UPS is prevented from running in normal operation.	
Alarm	Warning	Breaker MBB closed	Maintenance bypass breaker MBB is closed, feeding the load with unprotected power from bypass.	
Alarm	Warning	Breaker SIB open	System isolation breaker SIB is open, and system cannot feed the load.	
Alarm	Warning	Breaker SSIB open	Bypass static switch input breaker SSIB is open, making static bypass operation unavailable.	
Alarm	Warning	Breaker UIB open	Unit input breaker UIB is open, and the UPS is prevented from running in normal operation.	
Alarm	Warning	Breaker UOB open	Unit output breaker UOB is open, and UPS cannot feed the load.	
Alarm	Warning	Bypass frequency out of tolerance	Bypass input frequency is out of tolerance.	Check bypass input frequency and bypass input frequency setting.
Alarm	Warning	Bypass phase missing	Bypass input is missing a phase.	Check bypass input. Please contact Schneider Electric.
Alarm	Warning	Bypass phase sequence incorrect	The phase rotation on bypass input is incorrect.	Check bypass input. Please contact Schneider Electric.
Alarm	Warning	Bypass voltage out of tolerance	Bypass input voltage is out of tolerance and UPS is prevented from going into requested bypass mode.	
Alarm	Warning	Charge power is reduced	The battery charge power has been reduced.	The input for this functionality was activated, or the input current has reached the maximum limit. Please contact Schneider Electric.
Alarm	Warning	Communication cable termination missing or damaged	One or more communication cable terminators is/are missing or damaged.	
Alarm	Warning	Confirm redundancy lost and/or transfer to Forced Static Bypass	One or more communication cable terminators is/are missing or damaged.	
Alarm	Warning	Confirm Turn Load Off	Off button has been pushed while inverter is on and with no bypass available. User must confirm that the UPS turns off the power to the load.	Confirm turn off either via display or by pushing the off button again.
Alarm	Informational	Customer Input 1 activated	Customer input relay 1 is activated.	
Alarm	Informational	Customer Input 2 activated	Customer input relay 2 is activated.	

Alarm/Event	Severity	Display Text	Description	Corrective Action Text
Alarm	Warning	Delayed transfer from battery to normal operation	The delayed transfer from battery to normal operation is active.	
Alarm	Warning	Display communication is lost	Main Controller is unable to communicate with the display.	Please contact Schneider Electric.
Alarm	Warning	Display firmware incompatibility detected	The firmware of the display is detected as incompatible with the rest of the system.	Perform a firmware update.
Alarm	Critical	EPO Switch Activated	An emergency power off (EPO) switch is activated.	Deactivate the Emergency Power Off switch.
Alarm	Warning	External battery monitoring detected fault	Input relay indicates external battery monitoring detected fault	
Alarm	Critical	External charger off command: activated	Input relay for charger off is activated.	Please contact Schneider Electric.
Alarm	Critical	External energy storage monitoring: major alarm	Input relay indicates external energy storage monitoring has detected a major alarm.	Please contact Schneider Electric.
Alarm	Warning	External energy storage monitoring: minor alarm	Input relay indicates external energy storage monitoring has detected a minor alarm	Please contact Schneider Electric.
Alarm	Warning	External sync frequency out of tolerance	External sync frequency is out of tolerance.	Check external sync frequency.
Alarm	Warning	External sync phase missing	External sync is missing a phase.	Check External sync.
Alarm	Warning	External sync phase sequence incorrect	The phase rotation on external sync is incorrect.	Please contact Schneider Electric.
Alarm	Warning	External sync temporarily disabled	External sync has been temporarily disabled because UPS cannot lock and synchronize to the external sync source.	Check external sync
Alarm	Warning	External sync voltage out of tolerance	External sync voltage is out of tolerance and UPS is prevented from going into external sync mode.	
Alarm	Critical	Fan inoperable	UPS has one or more inoperable fans. Fan redundancy is lost.	
Alarm	Critical	Firmware update - Incorrect UPS operation mode	The UPS is no longer in the correct operation mode during firmware update. Risk of load drop.	Transfer UPS to maintenance bypass.
Alarm	Warning	Firmware versions in parallel UPS units are not identical	The firmware versions in parallel UPS units are not identical.	Firmware update all UPS units in the parallel system to the same version
Alarm	Critical	Flywheel inoperable	Input relay indicates that the flywheel is not working correctly.	
Alarm	Informational	Forced battery operation activated	Forced battery operation has been activated by user.	
Alarm	Critical	General parallel system event	The parallel system is not configured correctly or is not working correctly.	Please contact Schneider Electric.
Alarm	Informational	Genset is supplying the UPS	Input relay indicates that a genset is supplying the UPS.	
Alarm	Warning	Ground fault detected	Input relay indicates that a ground fault has been detected.	Please contact Schneider Electric.
Alarm	Warning	High Battery Temperature Level	The battery temperature is above the Alarm setting.	Check the battery temperature. A high temperature may decrease the battery lifetime.
Alarm	Informational	High Efficiency Mode disabled	High efficiency mode is disabled from an input relay.	
Alarm	Informational	High efficiency mode has been disabled by the system	High Efficiency Mode is disabled by the system as the maximum number of transitions has been exceeded.	Enable high efficiency mode again, or disable it permanently.

Alarm/Event	Severity	Display Text	Description	Corrective Action Text
Alarm	Informational	High efficiency mode is disabled due to bypass UTHD is above configured limit	High efficiency mode is disabled due to bypass UTHD is above configured limit.	
Alarm	Warning	High humidity threshold violation at remote sensor	A high humidity threshold violation exists for integrated Environmental Monitor sensor.	Please check the environment.
Alarm	Warning	High temperature threshold violation at remote sensor	A high temperature threshold violation exists for integrated Environmental Monitor sensor.	Please check the environment.
Alarm	Warning	Incorrect UPS configuration detected	Incorrect UPS configuration detected.	
Alarm	Warning	Input frequency out of tolerance	Mains input frequency is out of tolerance.	Check input frequency and input frequency setting.
Alarm	Warning	Input phase missing	Input is missing a phase.	Check input. Please contact Schneider Electric.
Alarm	Warning	Input phase sequence incorrect	The phase rotation on input is incorrect.	Check input. Please contact Schneider Electric.
Alarm	Warning	Input voltage out of tolerance	Mains input voltage is out of tolerance.	
Alarm	Warning	Inverter is Off due to a request by the user	The inverter is off due to a request by the user.	
Alarm	Warning	Inverter output is not in phase with bypass input	The UPS inverter output is not in phase with the bypass input.	
Alarm	Warning	Li-Ion AC Supply Breaker BMS: B1/BMS:B2 open	One or both Li-Ion BMS AC Supply Breakers are open.	
Alarm	Warning	Lost communication to remote sensor	Lost the local network management interface-to-integrated Environmental Monitor.	Please check the environment.
Alarm	Warning	Lost parallel redundancy	The load exceeds limit for an N+x UPS in redundancy (x is the configurable parallel redundancy).	Reduce the load on the system.
Alarm	Warning	Low Battery Temperature Level	The battery temperature is below the Alarm setting.	
Alarm	Warning	Low humidity threshold violation at remote sensor	A low humidity threshold violation exists for integrated Environmental Monitor sensor.	Please check the environment.
Alarm	Warning	Low temperature threshold violation at remote sensor	A low temperature threshold violation exists for integrated Environmental Monitor sensor.	Please check the environment.
Alarm	Warning	Magelis 10 inch display firmware incompatibility detected	The firmware of the Magelis 10 inch display is detected as incompatible with the rest of the system.	Perform a firmware update.
Alarm	Warning	Maintenance bypass breaker (MBB) closed	Maintenance bypass breaker (MBB) is closed, feeding the load with unprotected power from bypass.	
Alarm	Warning	Maximum humidity threshold violation at remote sensor	A maximum humidity threshold violation exists for integrated Environmental Monitor sensor.	Please check the environment.
Alarm	Warning	Maximum temperature threshold violation at remote sensor	A maximum temperature threshold violation exists for integrated Environmental Monitor sensor.	Please check the environment.
Alarm	Informational	Mega Tie is activated	Dry contact input indicates that Mega Tie is activated.	
Alarm	Warning	Minimum humidity threshold violation at remote sensor	A minimum humidity threshold violation exists for integrated Environmental Monitor sensor.	Please check the environment.
Alarm	Warning	Minimum temperature threshold violation at remote sensor	A minimum temperature threshold violation exists for integrated Environmental Monitor sensor.	Please check the environment.

Alarm/Event	Severity	Display Text	Description	Corrective Action Text
Alarm	Warning	Modular battery breaker open	Modular battery breaker is open.	
Alarm	Warning	Modular battery cabinet is not working correctly	Modular battery cabinet is not working correctly.	Check battery cabinet. Please contact Schneider Electric.
Alarm	Warning	NMC 1 firmware incompatibility detected	The firmware of the NMC in Smart Slot 1 is detected as incompatible with the rest of the system.	Perform a firmware update.
Alarm	Warning	NMC 2 firmware incompatibility detected	The firmware of the NMC in Smart Slot 2 is detected as incompatible with the rest of the system.	Perform a firmware update.
Alarm	Warning	Not enough UPS units ready to turn on inverter	One or more parallel UPS units have been requested to turn on inverter, but not enough UPS units are ready for system to enter inverter on operation.	Turn on inverter of more UPS units and/or check the setting "Minimum Number of UPS Required to Supply Load".
Alarm	Warning	Output frequency out of tolerance	Output frequency is out of tolerance.	Check output frequency and output frequency setting.
Alarm	Warning	Output voltage out of tolerance	The output voltage is out of tolerance.	
Alarm	Warning	Overload on installation	The load exceeds 100% of rated installation capacity.	Reduce load on system.
Alarm	Warning	Overload on UPS due to high ambient temperature	The load exceeds the rated capacity when running with high ambient temperature.	Reduce load on system or ambient temperature.
Alarm	Warning	Overload on UPS present. Load below continuous overload threshold	Reduce load on system or check for output short circuit.	The load exceeds 100% of rated capacity. Load is below the Continuous Overload threshold.
Alarm	Warning	Overload or short circuit on UPS	Reduce load on system or check for output short circuit.	The load exceeds 100% of rated capacity or there is a short circuit on the output.
Alarm	Warning	Parallel communication lost on PBUS cable 1	PBUS cable 1 may be damaged.	Replace parallel Cable 1.
Alarm	Warning	Parallel communication lost on PBUS cable 2	PBUS cable 2 may be damaged.	Replace parallel Cable 2.
Alarm	Warning	Parallel mixed operation mode	One or more parallel UPS units are operating in battery operation, while others are operating in normal operation.	
Alarm	Warning	Parallel unit not present	Main Controller is unable to communicate with parallel UPS X. The UPS might have been powered down or communication cables may be damaged.	
Alarm	Warning	Power cabinet inoperable	Power cabinet is inoperable.	Please contact Schneider Electric.
Alarm	Warning	Power cabinet mixed operation mode	One or more power cabinets are operating in battery operation, while others are operating in normal operation.	
Alarm	Warning	Power cabinet redundancy lost	The configured power cabinet redundancy is lost, either because the output load is too high, or because there are not enough power cabinets available.	Reduce the load on the system.
Alarm	Critical	Power cabinet surveillance internal event detected	Power Cabinet Surveillance detected an internal event.	Please contact Schneider Electric.
Alarm	Warning	Requested Bypass command from input contact activated	Requested Bypass command from input contact activated.	
Alarm	Critical	Restricted air flow	Restricted air flow.	This could be caused by a clogged air filter or other obstacle blocking air flow.
Alarm	Warning	RTC backup battery is discharged	The RTC backup battery is discharged or the time is not set correctly.	



Alarm/Event	Severity	Display Text	Description	Corrective Action Text
Alarm	Critical	Self-test - Did not pass	Self-test did not complete correctly.	Check event log and active alarms for more details.
Alarm	Warning	Startup recommended	The product has been running overtime without startup.	Please contact Schneider Electric for secure startup.
Alarm	Critical	Static bypass switch inoperable	Static bypass switch is inoperable. UPS is prevented from going into static bypass operation.	Please contact Schneider Electric.
Alarm	Warning	Static bypass switch warning	The static bypass switch needs a technical check but is still fully operational.	Please contact Schneider Electric.
Alarm	Critical	Surveillance detected fault	Surveillance detected fault.	Please contact Schneider Electric.
Alarm	Warning	Synchronization unavailable - system is freerunning	The UPS is unable to synchronize to the bypass input, external source or parallel system.	
Alarm	Warning	System isolation breaker (SIB) open	System isolation breaker (SIB) is open, and system cannot feed the load.	
Alarm	Critical	System locked in bypass operation	The system is locked in bypass operation.	The system has toggled between inverter operation and bypass operation more than 10 times within 1 minute. Please activate on button to transfer back to normal operation.
Alarm	Critical	System operation mode - Forced Static Bypass	The system is in bypass in response to a critical event or an inverter off request.	
Alarm	Warning	System operation mode - Maintenance Bypass	The system load is supplied through Maintenance Bypass Breaker (MBB).	
Alarm	Critical	System operation mode - Off	The system output power is turned off.	
Alarm	Warning	System operation mode - Requested Static Bypass	The system is in bypass in response to the UPS front-panel or a user-initiated software command, typically for maintenance.	
Alarm	Critical	System operation mode - Static Bypass Standby	The system is in static bypass standby operation in response to a critical event or an inverter off request.	
Alarm	Warning	Technical Check recommended	The product and its batteries need to be checked as preventive maintenance is recommended.	Please contact Schneider Electric.
Alarm	Warning	Transfer from battery to normal operation delay activated	Input relay indicates that the transfer from battery to normal operation delay is activated.	
Alarm	Warning	Unit input breaker (UIB) open	Unit input breaker (UIB) is open, and the UPS is prevented from running in normal operation	
Alarm	Warning	Unit output breaker (UOB) aux wiring not correct	Unit output breaker (UOB) aux wiring is not correct.	Please check UOB aux wiring. Both circuits must connect to a normally open switch.
Alarm	Warning	Unit output breaker (UOB) open	Unit output breaker (UOB) is open, and UPS cannot feed the load.	
Alarm	Warning	UPS locked in static bypass mode is activated	Input relay for UPS locked in static bypass mode is activated.	
Alarm	Critical	UPS configuration incorrect	UPS is configured incorrectly.	Please contact Schneider Electric.
Alarm	Warning	UPS operation mode - Battery	On battery power in response to an input power problem.	
Alarm	Informational	UPS operation mode - Battery Test	On battery power in response to a test of the performance of the batteries.	

Alarm/Event	Severity	Display Text	Description	Corrective Action Text
Alarm	Critical	UPS operation mode - Forced Static Bypass	The UPS is in bypass in response to a critical event or an inverter off request.	
Alarm	Informational	UPS operation mode - Initialize	The UPS is initializing.	
Alarm	Informational	UPS operation mode - Inverter Standby	The UPS is ready to enter battery operation but awaits permission from the system. UPS output is off.	
Alarm	Warning	UPS operation mode - Maintenance Bypass	The UPS load is supplied through Maintenance Bypass Breaker (MBB).	
Alarm	Critical	UPS operation mode - Off	The output power is turned off.	
Alarm	Warning	UPS operation mode - Requested Static Bypass	The UPS is in bypass in response to the UPS front-panel or a user-initiated software command, typically for maintenance.	
Alarm	Warning	UPS operation mode - Static Bypass Standby	The UPS is ready to enter static bypass but awaits permission from the system. UPS output is off.	
Alarm	Critical	UPS settings reset to default	Unit settings has been reset to default. The UPS is locked in off operation until settings are confirmed.	Please contact Schneider Electric.
Alarm	Warning	Warranty expiring soon	The product is reaching the end of warranty.	Please contact Schneider Electric.

## Tests

The UPS system can perform the following tests to ensure correct performance of the system:

- **Battery Test**
- **Runtime Calibration**
- **Battery SPoT Mode**
- **Annunciators**
- **Display Calibration**

### Perform a Battery Test

Prerequisites:

- The batteries must be more than 50% charged.
- The runtime available must be more than 4 minutes.
- The operation mode must be normal operation, EConversion, or ECO mode.
- The system operation mode must be normal, EConversion, or ECO mode.

This feature performs a number of tests on the batteries, such as fuse-blown check, weak battery detection. The test will discharge the battery, and use about 10% of the total capacity. Meaning if you have 10 minutes of runtime, the test will run for 1 minute. The **Battery Test** can be set up to run automatically in different time intervals (from weekly and up to once a year).

1. From the home screen on the display select **Tests > Battery Test**.
2. Tap the **Start Battery Self-Test** button.

**NOTE:** If you wish to manually stop the battery self-test, tap the **Abort Battery Self-Test** button.

## Perform a Runtime Calibration

This feature is used for calibrating the estimated remaining battery runtime value. In this test the UPS transfers to battery operation and the batteries are discharged to the low DC warning level. Based on the elapsed time and information about the load, the battery capacity can be calculated and the estimated runtime calibrated.

Schneider Electric recommends performing battery runtime calibration at start-up, when batteries are replaced, or when changes are made to the battery cabinets.

### **NOTICE**

#### **RISK OF EQUIPMENT DAMAGE**

- During a runtime calibration the batteries will be at a very low level and therefore not capable of supporting your system load in case of a input power failure.
- Batteries will be discharged to 10% capacity and this will result in a low battery runtime after the calibration.
- Repeated battery testing or calibration can affect the lifetime of the battery.

**Failure to follow these instructions can result in equipment damage.**

Prerequisites:

- Batteries must be 100% charged.
- The load percentage must be at least 10% and must not change more than 20% during test.
- The bypass supply must be available.
- The operation mode must be normal operation, EConversion, or ECO mode.
- The system operation mode must be inverter, EConversion, or ECO mode.

1. From the home screen on the display select **Tests > Runtime Calibration**.
2. Tap the **Start Runtime Calibration** button.

**NOTE:** If you wish to manually stop the runtime calibration, tap the **Abort Runtime Calibration** button.

## Perform a Battery SPoT Mode Test

**NOTE:** Battery SPoT Mode test is only legal in some countries/ares. Please refer to local/national legislation.

Prerequisites:

- The unit output breaker UOB must be open
- The UPS operation mode must be requested static bypass
- The battery breaker(s) BB must be closed
- There must be no detected surveillance faults
- The static switch input breaker SSIB must be closed
- The output voltage and frequency must be within predefined limits

This feature performs a battery discharge test without the need for a load bank. During the battery SPoT mode test, the inverter is turned ON while the UPS is in requested static bypass. During the test, the UPS performs a battery runtime calibration test and adjusts the estimated runtime accordingly.

The output power can be manually adjusted from 0 to 100% load to be as closed as possible to the operating conditions.

The battery SPoT mode test stops when the battery voltage has reached its shutdown level, or when the predefined discharge level has been reached.

**NOTE: Battery SPoT Mode** must be enabled by Schneider Electric during service configuration to make battery SPoT mode available.

1. From the home screen on the display select **Tests > Battery SPoT Mode**.
2. Go through the **Battery SPoT Mode** screens and verify that the prerequisites for performing a test is met.
3. Set the battery discharge level and the output power level.

The screenshot shows the 'Battery Spot Mode' configuration screen. At the top, there is a navigation bar with a home icon, 'Tests', and 'Battery Spot Mode'. Below the navigation bar, there are two input fields: 'Battery Discharge Level: [ ] % [0 - 100]' and 'Output Power Setting: [ ] % [0 - 100]'. At the bottom, there is a control bar with buttons for 'ESC', '<', '3/4', '>', and 'OK'.

4. Tap the **Start Battery SPoT Mode** button.

**NOTE:** If you wish to manually stop the battery SPoT mode test, tap the **Abort Battery SPoT Mode** button.

## Perform an Annunciators Test

1. From the home screen on the display select **Tests > Annunciators**.
2. Tap the **Start** button to initiate the test.  
During the annunciators test the LEDs on the display and the mimic diagram and the audible alarm are tested.

## Calibrate the Display

From the home screen on the display select **Tests > Display Calibration** and then select the calibration you want to perform.

- **Calibrate:** Tests and adjusts the touch screen target sensitivity.
- **Calibration Check:** Checks the calibration adjustments.

# 10" System Bypass Display

## 10" System Bypass Display Menu Tree (Option)

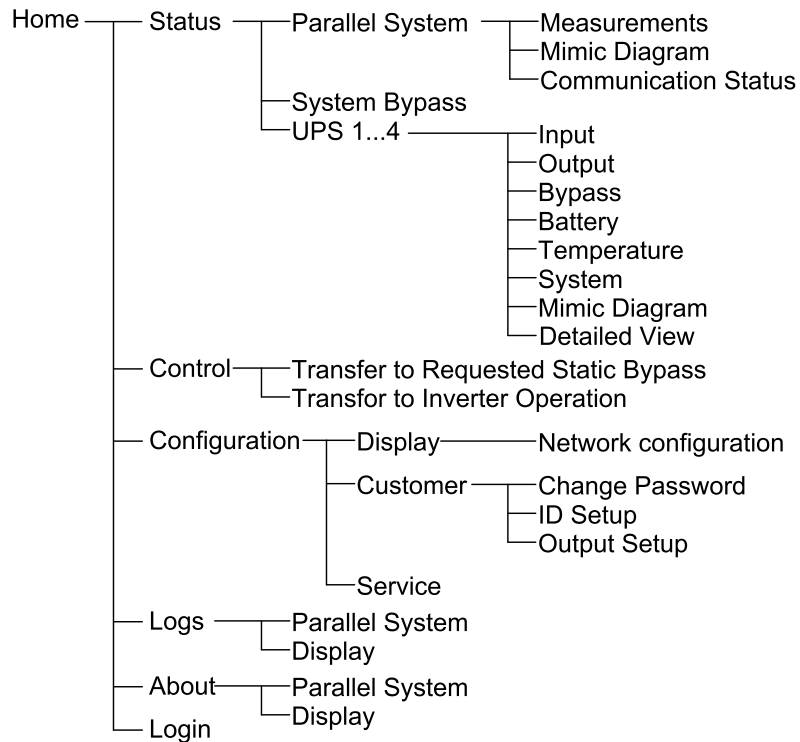

## Configuration from the 10" System Bypass Display (Option)

### Configure the Display Settings

1. From the home screen on the display select **Configuration > Display**.

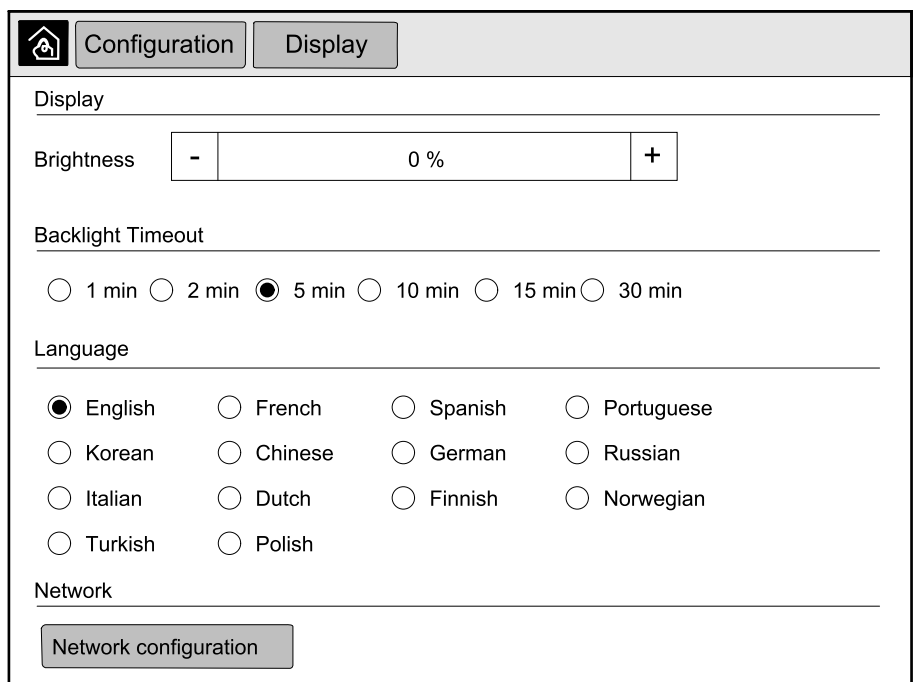

2. Set the brightness of the display via the **Brightness** indicator. Tap **+** to increase the brightness and tap **-** to decrease the brightness.

3. Set the backlight timeout. Choose between **1, 2, 5, 10, 15,** or **30** minutes.
4. Set the language of the display.
5. Configure the network by tapping the **Network configuration** button and typing in the **IP Address, Mask,** and **Gateway**. Complete with **OK**.

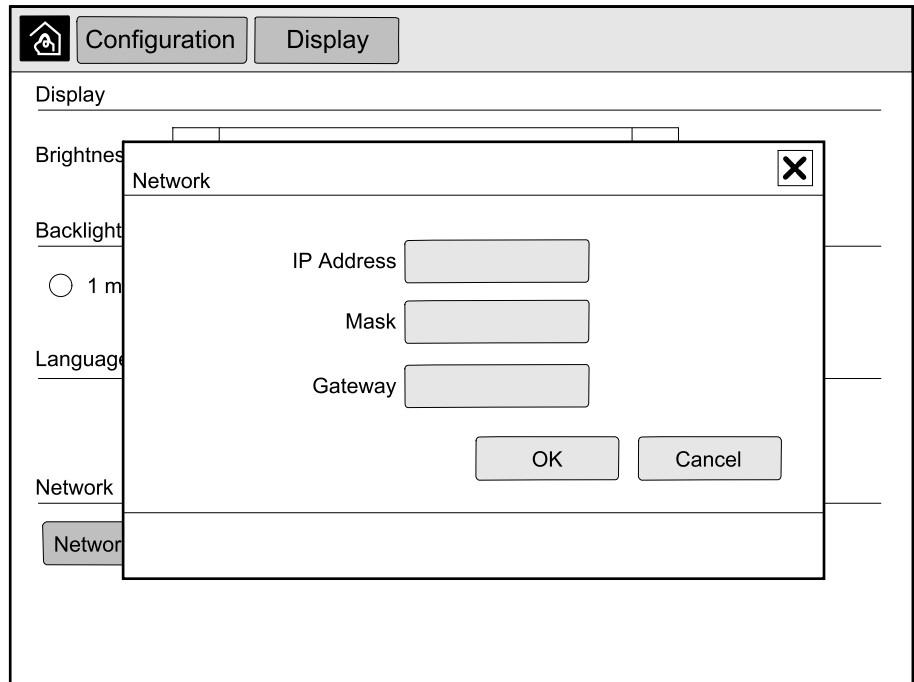

6. Tap the home button to exit the configuration screen.

## Change the User Password

1. From the home screen on the display select **Configuration > Customer > Change Password**.

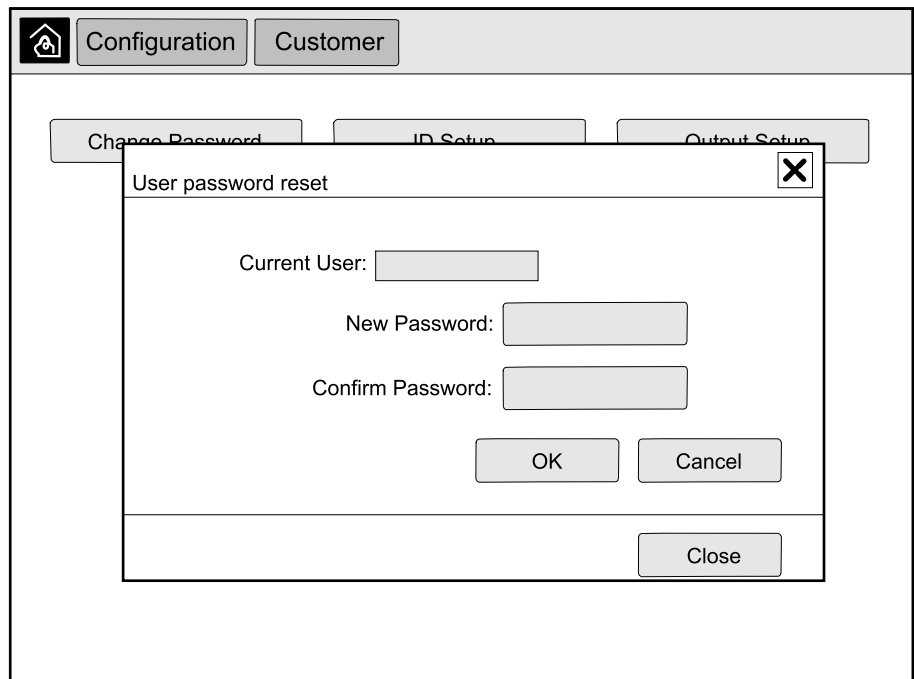

2. Type in **New Password** and **Confirm Password** and complete with **OK**.
3. Tap **Close** or the **X** button to exit the **User password reset** pop-up screen.
4. Tap the home button to exit the configuration screen.

## Change the System Names

1. From the home screen on the display select **Configuration > Customer > ID Setup**.

The screenshot shows the 'ID Setup' configuration screen. At the top, there are three tabs: 'Configuration', 'Customer', and 'ID Setup'. The 'ID Setup' tab is selected. The screen is divided into four main sections, each with a title and a list of input fields:

- UPS (10 Characters):** Contains three input fields labeled 'UPS 1', 'UPS 2', and 'UPS 3'.
- Input (10 Characters):** Contains three input fields labeled 'Input 1', 'Input 2', and 'Input 3'.
- Output (14 Characters):** Contains one input field labeled 'System Output'.
- Bypass (18 Characters):** Contains three input fields labeled 'Maintenance Bypass', 'Bypass', and 'System Bypass'.

At the bottom right of the screen, there are two buttons: 'OK' and 'Cancel'.

2. The following names can be changed.
  - UPS
  - Input
  - System Output
  - Maintenance Bypass
  - Bypass
  - System Bypass
3. Tap **OK** to confirm your settings.
4. Tap the home button to exit the configuration screen.

## Configure the Output Distribution Breakers

1. From the home screen on the display select **Configuration > Customer > Output Setup**.

Output Distribution Breaker		Normal State	
ODB1	<input checked="" type="radio"/> Not Present <input type="radio"/> Present	<input type="radio"/> Open	<input checked="" type="radio"/> Closed
ODB2	<input checked="" type="radio"/> Not Present <input type="radio"/> Present	<input type="radio"/> Open	<input checked="" type="radio"/> Closed
ODB3	<input checked="" type="radio"/> Not Present <input type="radio"/> Present	<input type="radio"/> Open	<input checked="" type="radio"/> Closed
ODB4	<input checked="" type="radio"/> Not Present <input type="radio"/> Present	<input type="radio"/> Open	<input checked="" type="radio"/> Closed
ODB5	<input checked="" type="radio"/> Not Present <input type="radio"/> Present	<input type="radio"/> Open	<input checked="" type="radio"/> Closed
Load Bank Breaker		Normal State	
<input type="radio"/> Not Present	<input checked="" type="radio"/> Present	<input checked="" type="radio"/> Open	<input type="radio"/> Closed
	<input checked="" type="radio"/> Downstream of SIB		
	<input type="radio"/> Upstream of SIB		

OK Cancel

2. Select **Present** for the output distribution breakers that are available in the parallel system.
3. Select **Present** for the **Load Bank Breaker** if it is part of the parallel system and indicate whether the load bank breaker is **Upstream of SIB** or **Downstream of SIB**.
4. Tap **OK** to confirm your settings.
5. Tap the home button to exit the configuration screen.

## Operation Procedures from the 10" System Bypass Display (Option)

### Access Password-Protected Screens

**NOTE:** The default administrator username/password are admin/admin. Change the password after logging in the first time, and change the password regularly.

**NOTE:** The default user username/password are config/config.

1. When prompted for the password, tap the **Username** field to access the keyboard.
2. Tap the username field, type in your username, and tap **Enter**.
3. Tap the **Password** field, type in your password, and tap **Enter**.
4. Tap **Login**.
5. Tap **Close** or the **X** button to exit the **Login** pop-up screen.

### View the Parallel System Status

1. From the home screen on the display select **Status > Parallel System**.



2. Select the area for which you wish to see the status. Choose between:

**Measurements**

<b>Input Current (A)</b>	The present phase-to-phase input current in amperes (A).
<b>Output Current (A)</b>	The present phase-to-phase output current in amperes (A).
<b>Bypass Current (A)</b>	The present phase-to-phase bypass current in amperes (A).
<b>Number of Parallel UPS</b>	The total number of UPSs in the parallel system.
<b>Number of Redundant UPS</b>	The redundancy for the parallel system.
<b>Number of Redundant Power Cabinets per UPS</b>	The number of redundant power cabinets in each UPS.
<b>Output Total Apparent Power (kVA)</b>	The present total apparent output power (for all three phases) in thousands of Volt-Amps (kVA).
<b>Output Total Active Power (kW)</b>	The present total active output power (for all three phases) in kilowatts (kW).
<b>Output Total Load (%)</b>	The percentage of the UPS system capacity presently used across all phases. The load percentage for the highest phase load is displayed.

**Mimic Diagram**

<b>Mimic Diagram</b>	The mimic diagram shows the current status of the main parts of the UPS system: power sources, converters, bypass static switch and breakers, and it shows the power flow through the system.
----------------------	---

**NOTE:** You can click the UPS or the system bypass to get a more detailed mimic diagram.

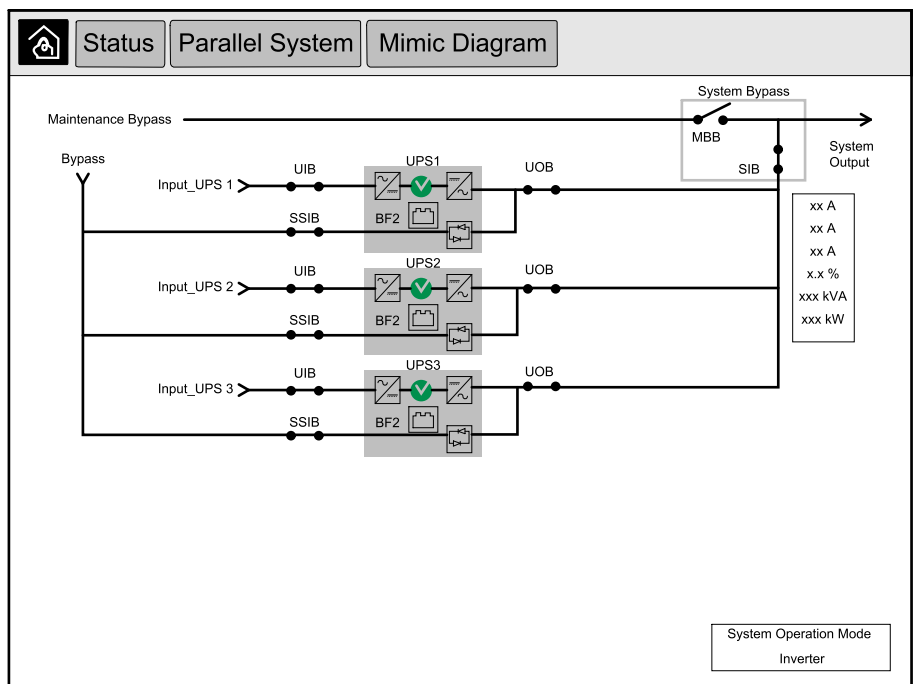

**Communication Status**

<b>Communication Status</b>	The communication status diagram shows the communication status between the display and the UPSs of the parallel system.
-----------------------------	--

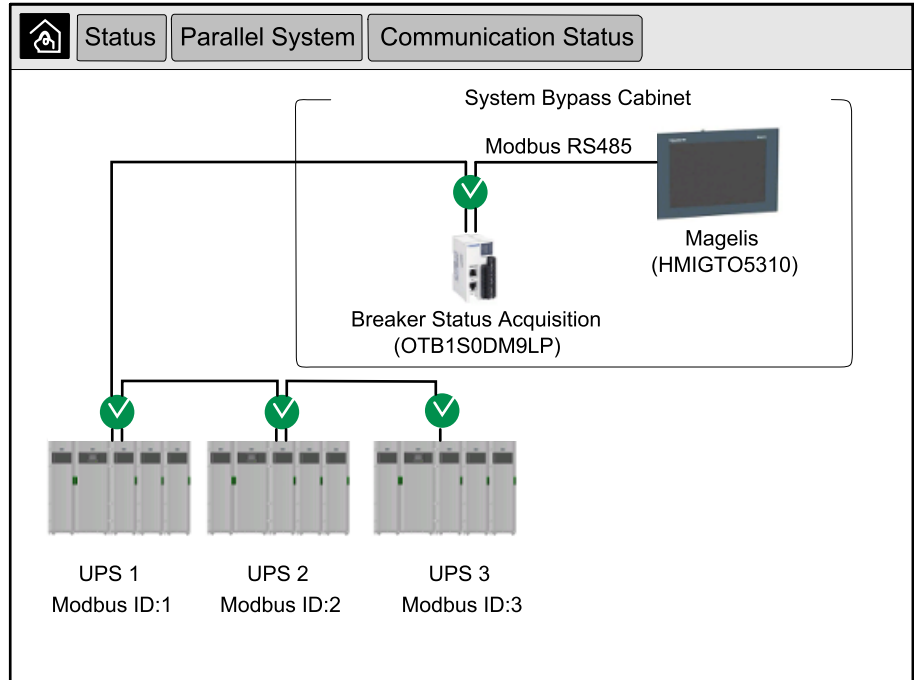

3. Tap the home button to exit the screens and return to the home screen.

### View System Bypass Status

1. From the home screen on the display select **Status > System Bypass**.

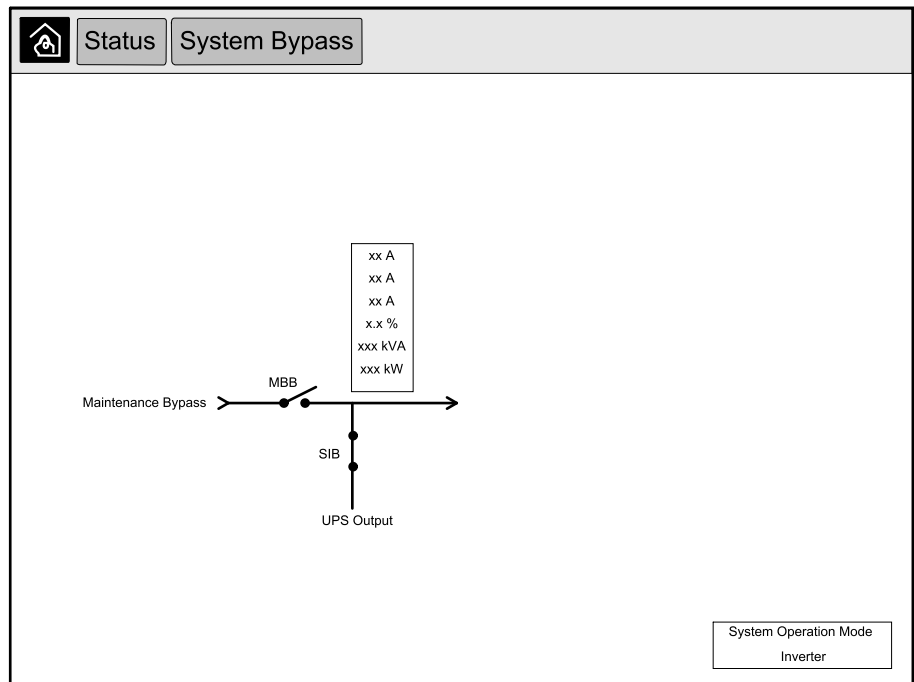

2. Tap the home button to exit the screens and return to the home screen.

### View UPS Status Information

1. From the home screen on the display select **Status > UPS X**.

2. Select the area for which you wish to see the status. Choose between:

### Input

<b>Voltage (V) phase-to-neutral<sup>5</sup></b>	The present phase-to-neutral input voltage in volts (V).
<b>Current (A)</b>	The present input current from the AC utility power source per phase in amperes (A).
<b>Peak RMS Current (A)</b>	The maximum current for the latest 30 days.
<b>Apparent Power (kVA)</b>	The present apparent input power for each phase in kVA. Apparent power is the product of RMS (root mean square) volts and RMS amperes.
<b>Active Power (kW)</b>	The present active input power (or real power) for each phase in kilowatts (kW). Active power is the portion of power flow that, averaged over a complete cycle of the AC waveform, results in net transfer of energy in one direction.
<b>Power Factor</b>	The ratio of the active power to apparent power.
<b>Voltage (V) phase-to-phase</b>	The present phase-to-phase input voltage.
<b>Total Apparent Power (kVA)</b>	The present total apparent input power (for all three phases) in kVA.
<b>Total Active Power (kW)</b>	The present total active input power (for all three phases) in kW.
<b>Frequency (Hz)</b>	The present input frequency in hertz (Hz).
<b>Energy (kWh)</b>	The total energy consumption since the time of installation or since the number was reset.

### Output

<b>Voltage (V) phase-to-neutral<sup>5</sup></b>	The phase-to-neutral output voltage at the inverter in volts (V).
<b>Current (A)</b>	The present output current for each phase in amperes (A).
<b>Peak RMS Current (A)</b>	The maximum current for the latest 30 days.
<b>Apparent Power (kVA)</b>	The present apparent output power for each phase in kVA. Apparent power is the product of RMS (root mean square) volts and RMS amperes.
<b>Active Power (kW)</b>	The present active output power (or real power) for each phase in kilowatts (kW). Active power is the portion of power flow that, averaged over a complete cycle of the AC waveform, results in net transfer of energy in one direction.
<b>Power Factor</b>	The present output power factor for each phase. Power factor is the ratio of active power to apparent power.
<b>Current Crest Factor</b>	The present output crest factor for each phase. The output crest factor is the ratio of the peak value of the output current to the RMS (root mean square) value.
<b>Current THD (%)</b>	The THD (total harmonic distortion) for each phase, as a percentage, for the present output current.
<b>Voltage (V) phase-to-phase</b>	The phase-to-phase output voltage at the inverter in volts (V).
<b>Total Apparent Power (kVA)</b>	The present apparent output power for each phase in thousands of Volt-Amps (kVA). Apparent power is the product of RMS (root mean square) volts and RMS amperes.
<b>Total Active Power (kW)</b>	The present total active output power (for all three phases) in kilowatts (kW).
<b>Load (%)</b>	The percentage of the UPS capacity presently used across all phases. The load percentage for the highest phase load is displayed.
<b>Neutral Current (A)<sup>1</sup></b>	The present output neutral current in amperes (A).
<b>Frequency (Hz)</b>	The present output frequency in hertz (Hz).
<b>Inverter Status</b>	The general condition of the inverter.
<b>PFC Status</b>	The general condition of the PFC.
<b>Energy (kWh)</b>	The total energy supplied since the time of installation or since the value was reset.

### Bypass

<b>Voltage (V) phase-to-neutral<sup>5</sup></b>	The present phase-to-neutral bypass voltage (V).
<b>Current (A)</b>	The present bypass current for each phase, in amperes (A).

<sup>5</sup> Only applicable in systems with neutral connection.

**Bypass (Continued)**

<b>Peak RMS Current (A)</b>	The maximum current for the latest 30 days.
<b>Apparent Power (kVA)</b>	The present apparent bypass power for each phase in kVA. Apparent power is the product of RMS (root mean square) volts and RMS amperes.
<b>Active Power (kW)</b>	The present active bypass power for each phase in kilowatts (kW). Active power is the time average of the instantaneous product of voltage and current.
<b>Power Factor</b>	The present bypass power factor for each phase. Power factor is the ratio of active power to apparent power.
<b>Voltage (V) phase-to-phase</b>	The present phase-to-phase bypass voltage (V).
<b>Total Apparent Power (kVA)</b>	The present total apparent bypass power (for all three phases) in thousands of Volt-Amperes (kVA).
<b>Total Active Power (kW)</b>	The present total active bypass power (for all three phases) in kilowatts (kW).
<b>Frequency (Hz)</b>	The present bypass frequency in hertz (Hz).

**Battery**

<b>Voltage (V)</b>	The present battery voltage.
<b>Current (A)</b>	The present battery current in amperes (A). A positive current indicates that the battery is charging; a negative current indicates that the battery is discharging.
<b>Power (kW)</b>	The present DC power being drawn from the battery, in kilowatts (kW).
<b>Estimated Charge Level (%)</b>	The present battery charge, as a percentage of full charge capacity.
<b>Estimated Charge Time (h:mn)</b>	The estimated time, in minutes, until the batteries reach 100% charge.
<b>Runtime Remaining (h:mn)</b>	The amount of time in hours and minutes before the batteries reach the low-voltage shutdown level.
<b>Charger Mode</b>	The operation mode of the charger (Off, Float, Boost, Equalization, Cyclic, Test).
<b>Battery Status</b>	The general condition of the battery.
<b>Charger Status</b>	The general condition of the charger.
<b>Total Battery Capacity (Ah)</b>	The total capacity available from the available batteries.
<b>Battery Temperature C°</b>	The highest battery temperature from the connected temperature sensors.

**Temperature**

<b>Temperature</b>	Ambient temperature in degrees Celsius or Fahrenheit for the I/O cabinet and each power cabinet.
--------------------	--

**System**

<b>Output Voltage</b>	The phase-to-phase output voltage at the inverter in volts (V).
<b>Output Current</b>	The present output current for each phase in amperes (A).
<b>Output Frequency</b>	The present output frequency in hertz (Hz).
<b>Runtime Remaining</b>	The amount of time in hours and minutes before the batteries reach the low-voltage shutdown level.
<b>System Time</b>	The time of the UPS system.
<b>UPS Operation Mode</b>	The operation mode of the operated UPS.
<b>System Operation Mode</b>	The operation mode of the complete UPS system.
<b>Total Output Power</b>	The apparent and active power (or real power) output for each phase.
<b>Output Power</b>	The phase-to-phase apparent and active output power (or real power) for each phase.

**Mimic Diagram**

Mimic Diagram	The mimic diagram shows the current status of the main parts of the UPS: power sources, converters, bypass static switch and breakers, and it shows the power flow through the UPS.
---------------	---

**Detailed View**

Detailed view	The detailed view shows the system with a status icon on each individual power cabinet and the actual number of redundant power cabinets. The detailed view also shows the apparent power and active power per phase.
---------------	---

	L1	L2	L3
Apparent Power (kVA)	xxxx	xxxx	xxxx
Active Power (kVA)	xxxx	xxxx	xxxx

3. Tap the home button to exit the screens and return to the home screen.

**Transfer the Parallel System from Normal to Requested Static Bypass Operation**

Please note that only the administrator can change operation mode.

1. From the home screen on the display select **Control**.

2. Tap the **Transfer to Requested Static Bypass** button.  
**NOTE:** If the conditions for performing the transfer are not met, the button will be grayed out.
3. Verify that the **System Operation Mode** changes to **Requested Static Bypass**.

## Transfer the Parallel System from Requested Static Bypass to Normal Operation

Please note that only the administrator can change operation mode.

1. From the home screen on the display select **Control**.
2. Tap the **Transfer to Inverter Operation** button.  
**NOTE:** If the conditions for performing the transfer are not met, the button will be grayed out.
3. Verify that the **System Operation Mode** changes to **Inverter**.

## Connect to the 10" System Bypass Display Remotely

1. In Internet Explorer 10 or newer, type in the IP address of the display. If you want to disable this feature, ensure that the IP address of the display is left blank.
2. If requested, follow Active X installation instructions.
3. Select the **Monitoring** tab and then select **Web Gate > New Window** in the left pane.  
 You now have access to the status and log information of the parallel system.
4. Log in with your username and password. Please ensure that you change your password before using the remote feature in order to secure your connection. It is recommended to change your password regularly.



## Troubleshooting from the 10" System Bypass Display (Option)

### View the Display Log

**NOTE:** This log is only related to the display operation and not to the operation of the UPS system.

1. From the home screen on the display select **Logs > Display**.

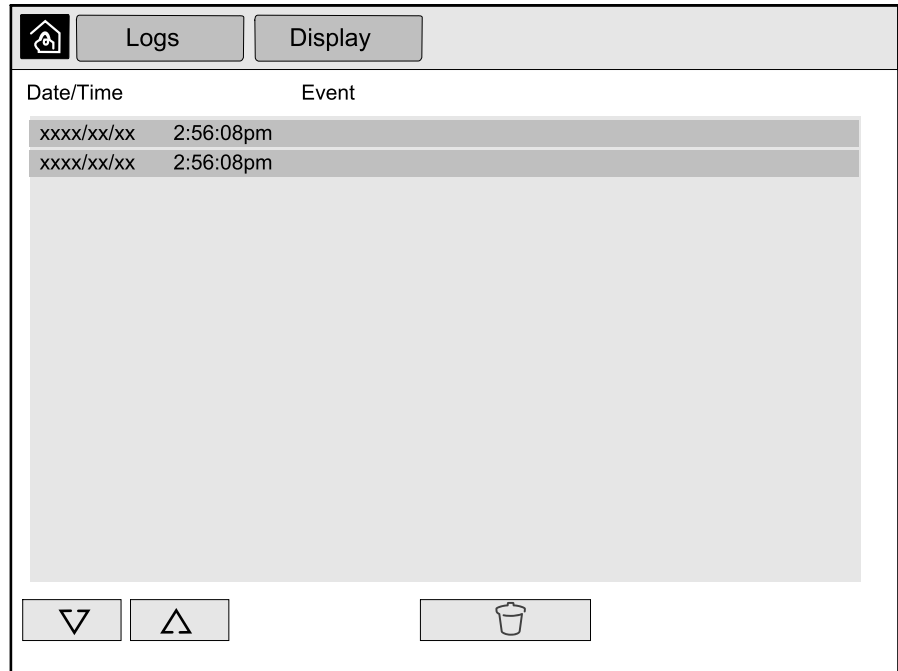

2. You can perform the following operations in the log:
  - a. Tap the arrows to browse through the list of events.
  - b. Tap the recycle bin button to clear the log.<sup>6</sup>
3. Tap the home button to exit the log.

## View the Parallel System Log

1. From the home screen on the display select **Logs > Parallel System**.

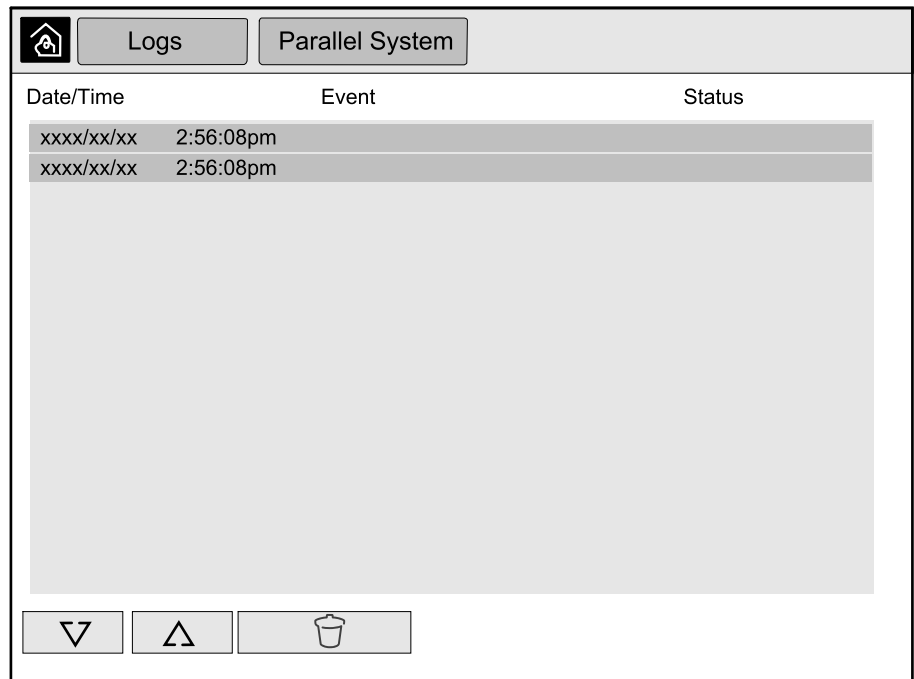

2. You can perform the following operations in the log:
  - a. Tap the arrows to browse through the list of events.
  - b. Tap the recycle bin button to clear the log.<sup>6</sup>

<sup>6</sup> This action is only available to the administrator.

3. Tap the home button to exit the log.

## View the Active Alarms

1. Tap the symbol in the top right corner of the screen.

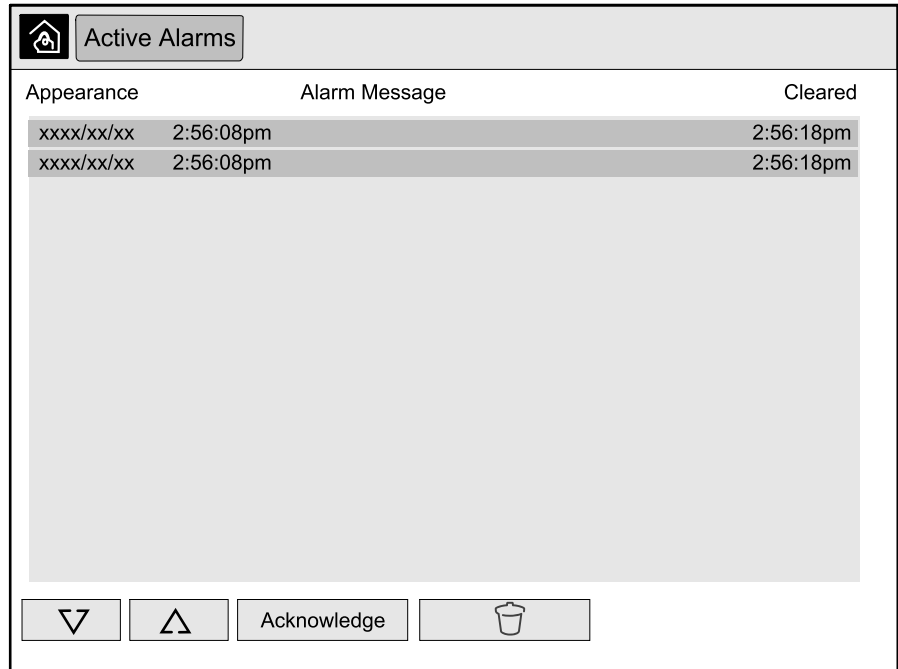

2. You can perform the following operations on the **Active Alarms** screen:
  - a. Tap the arrows to browse through the list of active alarms.  
The active alarms are colored according to the alarm level:
    - Green: No active alarms present
    - Blue: Informational alarm present
    - Yellow: Warning alarm present
    - Red: Critical alarm present
  - b. Tap the recycle bin button to clear the active alarms list.<sup>7</sup>
  - c. Tap the Acknowledge button to stop the flashing of the active alarms.
3. Tap the home button to exit the active alarms list.

<sup>7</sup> This action is only available to the administrator.



# Maintenance

## Replace the Top Filter

Rear View of the Front Door

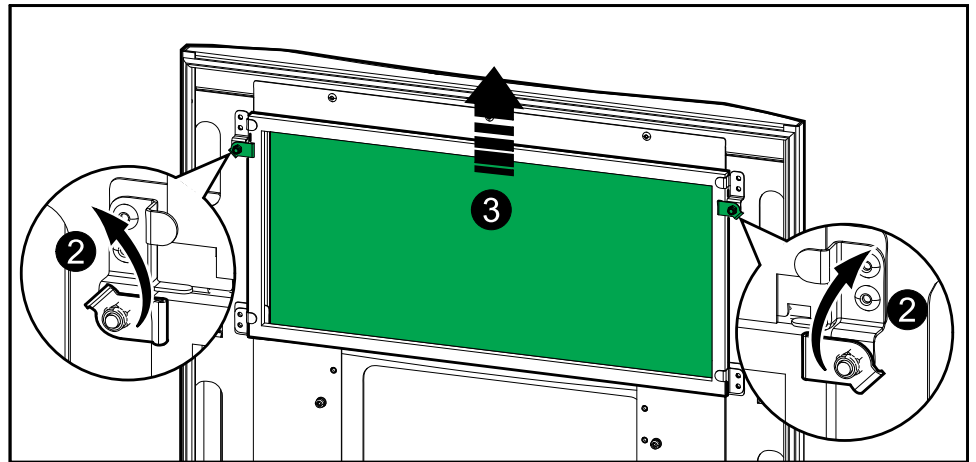

1. Open the front door of the cabinet.
2. Turn the filter locks to release the filter.
3. Lift up the filter.
4. Take the replacement filter from the installation kit and install the new filter.
5. Turn the filter locks to fasten the filter.

## Replace the Three Bottom Filters

Rear View of the Front Door

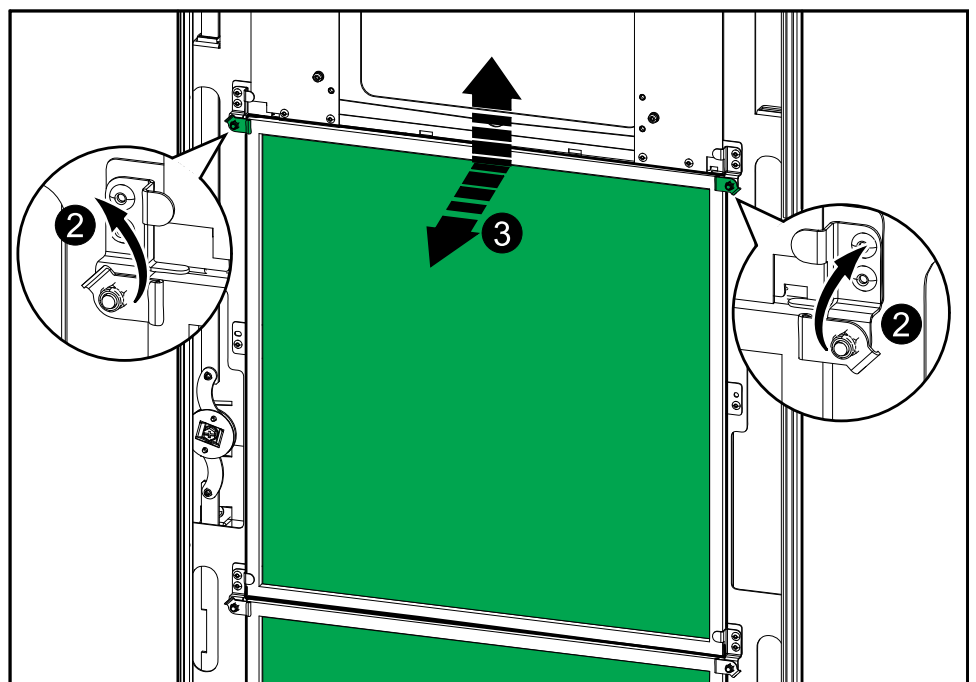

1. Open the front door of the cabinet.
2. Turn the filter locks to release the filters.
3. Tilt the filters out and lift them up.

4. Take the replacement filters from the installation kit and install the new filters.
5. Turn the filter locks to fasten the filters.

# Troubleshooting

## Determine if you need a Replacement Part

To determine if you need a replacement part, contact Schneider Electric and follow the procedure below so that the representative can assist you promptly:

1. In the event of an alarm condition, scroll through the alarm lists, record the information, and provide it to the representative.
2. Write down the serial number of the unit so that you will have it easily accessible when you contact Schneider Electric.
3. If possible, call Schneider Electric from a telephone that is within reach of the display so that you can gather and report additional information to the representative.
4. Be prepared to provide a detailed description of the problem. A representative will help you solve the problem over the telephone, if possible, or will assign a return material authorization (RMA) number to you. If a module is returned to Schneider Electric, this RMA number must be clearly printed on the outside of the package.
5. If the unit is within the warranty period and has been started up by Schneider Electric, repairs or replacements will be performed free of charge. If it is not within the warranty period, there will be a charge.
6. If the unit is covered by a Schneider Electric service contract, have the contract available to provide information to the representative.

## Find the Serial Numbers

**NOTE:** If the display is not available, the serial number can also be found on a label in each specific cabinet.

1. From the home screen on the display interface select **About > UPS**.
2. On the first page note down the serial number of the I/O cabinet and have it ready for customer support.
3. Press the arrow to go to the next page and note down the serial numbers of the power cabinets and have them ready for customer support.

## Return Parts to Schneider Electric

To return an inoperable part to Schneider Electric, contact Schneider Electric customer support to obtain an RMA number.

Pack the part in the original shipping materials, and return it by insured, prepaid carrier. The customer support representative will provide the destination address. If you no longer have the original shipping materials, ask the representative about obtaining a new set.

- Pack the part properly to avoid damage in transit. Never use styrofoam beads or other loose packaging materials when shipping a part. The part may settle in transit and become damaged.
- Enclose a letter in the package with your name, RMA number, address, a copy of the sales receipt, description of the problem, a phone number, and a confirmation for payment (if necessary).

**NOTE:** Damages sustained in transit are not covered under warranty.

Schneider Electric  
35 rue Joseph Monier  
92500 Rueil Malmaison  
France

+ 33 (0) 1 41 29 70 00



As standards, specifications, and design change from time to time,  
please ask for confirmation of the information given in this publication.

© 2016 – 2020 Schneider Electric. All rights reserved.

990-5452H-001