

ALGO



IP Paging | Alerting | Intercom



Unified Emergency & Mass Notification Software

**During the webinar please use the Q&A feature
located in bottom right corner of your screen!**

**We will answer the questions at the end of the presentation
Thank you!**

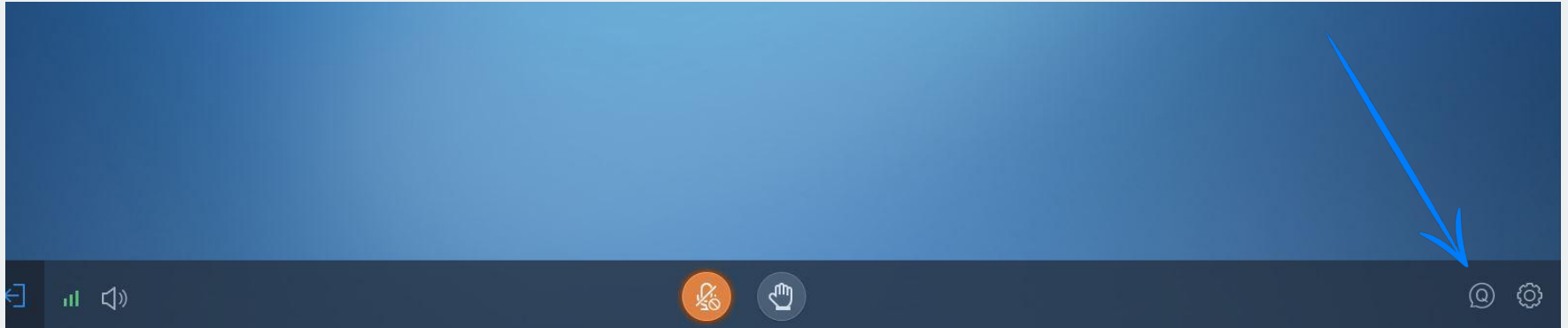



Since 2002 VoIP Supply has delivered unparalleled service and expertise to over 125,000 customers worldwide.

VoIP Rental Program

our Device as a Service (DaaS) rental program gives your customers the widest variety of VoIP Products for a low monthly payment!

Hardware & Provisioning

featuring over 60 manufacturers that offer over 16,000 products and the ability to provision for you!

CloudSpan MarketPlace

a single place to shop various VoIP service providers - build up your MRR and receive discounts on hardware selling through VoIP Supply

Fulfillment

provisioning and professional services from multiple warehouse locations in North America; providing real-time access to manage your projects from order through delivery

Refresh & Reclaim

offering certified reconditioned devices at a fraction of the cost plus offering an outlet for selling off used and excess VoIP equipment

Presenter's for today's session



Trusted VoIP Consultant. Motorcycle Enthusiast. Pizza Aficionado. Musician.

Brian Hyrek is a Solutions Consultant at VoIP Supply located in Amherst, New York. Brian has been in the VoIP Industry for nearly 10 years. Solution providing for communication needs with personal attention and care is something Brian is very passionate about. Brian specializes in solutions for Integrators, Resellers, and Service Providers. If you need assistance creating a solution for your communication needs, don't hesitate to reach out to Brian.



Scott Farrell is the Strategic Accounts representative for Algo Communication products in North America. Scott has served in several customer facing roles in the technology sector since 1987 working for Bell Canada, Nortel Networks and Avaya. Scott joined Algo Communication Products in 2017 with a focus on expanding relationships with distribution channels, integration partners and end user clients.



Ian Pitts is President and CEO of Syn-Apps. Ian has been in the technology industry for more than 20 years and has led the strategic direction of Syn-Apps since its founding in 2001. Ian has focused the company on innovation in the Emergency Mass Notification sector, serving thousands of customers in 35+ countries.

ALGO

Critical safety or security function



Common infrastructure



- Voice
- Data
- Security
- Paging

Industry influencing change

Network configurable and easily managed



New SIP UC environment



What is Mass Notification?

NFPA 72 defines an emergency communication systems as ***“A system for the protection of life by indicating the existence of an emergency situation and communicating information necessary to facilitate an appropriate response and action.”***

This can be in the form of multiple communication methods:

- In-Building / on-premise notifications / Wide-Area Notifications
 - PAVA, VoIP alerts, Digital Sign override, Desktop overrides, Fire Alarm, One-way & two-way communication systems, etc
- External / distributed recipient mass notification
 - SMS, Email, Push Notifications (mobile devices), Automated Dialed Calls, Collaboration Tools, Social Media channels
- The world we live in today is driving market demand for unified notification solutions (*mass shootings, pandemics, extreme weather, etc*)
 - Syn-Apps offers solutions for both on-premise mass notification and external communication, however, our core focus is to alert those located on-premise first and then notify people who may be located away from the scene

MEET **Revolution**



INTEGRATE



COMMUNICATE



PROTECT

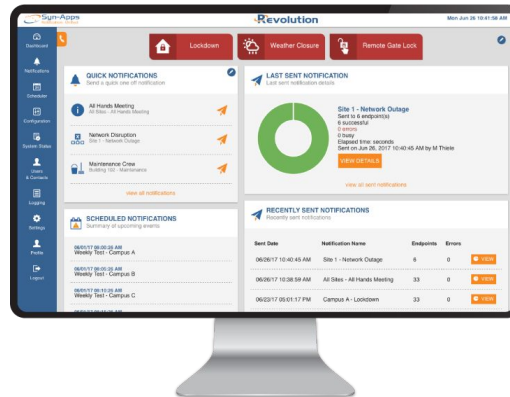

- Comprehensive
- Flexible & Open
- Simple to Operate
- Single Console

- Lowest TCO
- Improved Efficiency
- Reliable Emergency Communication

Activation Methods



Revolution UI



Revolution Mobile App



IP Buttons



NWS CAP Activator



Desktop Phone



Fire Alarm Panel



Revolution Scheduler



IPAWS EAS Activator



Revolution CAP Activator



Revolution AMBER Alert Activator



Collaboration Tools



Email Activator



Input Audio Stream



911 Dial Monitor



Status Activator



Cloud API (Third Party)



Revolution API



SNMP

Revolution



ALGO

ALGO Devices with **Revolution**

*Certified Plug-and-Play interoperable
with Syn-Apps Software*



8186 SIP Horn
Speaker



8189 Ceiling
Speaker



8188 SIP Ceiling
Speaker



8180 SIP
Alerter

*Other Compatible Devices with
Syn-Apps Software*



8128 / 8138
SIP Strobe



8201 PoE SIP
Intercom



8190 Clock /
Speaker



8301 Paging
Adapter



8036 SIP
Multimedia
Intercom

Verticals

- Education
- Healthcare
- Manufacturing
- Transportation
- Logistics
- Retail
- Hospitality



ALGO

- Plug-and-play integration with Syn-Apps
- Paging
- Loud ringing
- IP multicast scalable
- Supervisable
- Multiple paging zones
- Wideband G.722 HD voice

8180



8189



8188



8186



IP speakers

- PoE 802.3af
- Ambient noise adaptive
- Embedded microphone
- Two-way talkback
- Audio memory for WAV file
- Web interface for management
- TLS, SIPS, SRTP, LLDP/CDP

- High visibility digital clock
- White on black contrast
- Digits are 30mm 2.3" tall
- RGB programmable LEDs
- Optional strobe



8190s

- PoE + 802.3at
- Four speaker line array
- Asymmetric sound dispersion
- Embedded microphone
- Integrated backlit button

ALGO

Ambient noise response



Microphone

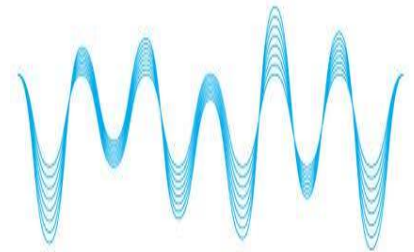
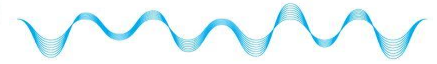

Typical Analog Paging System

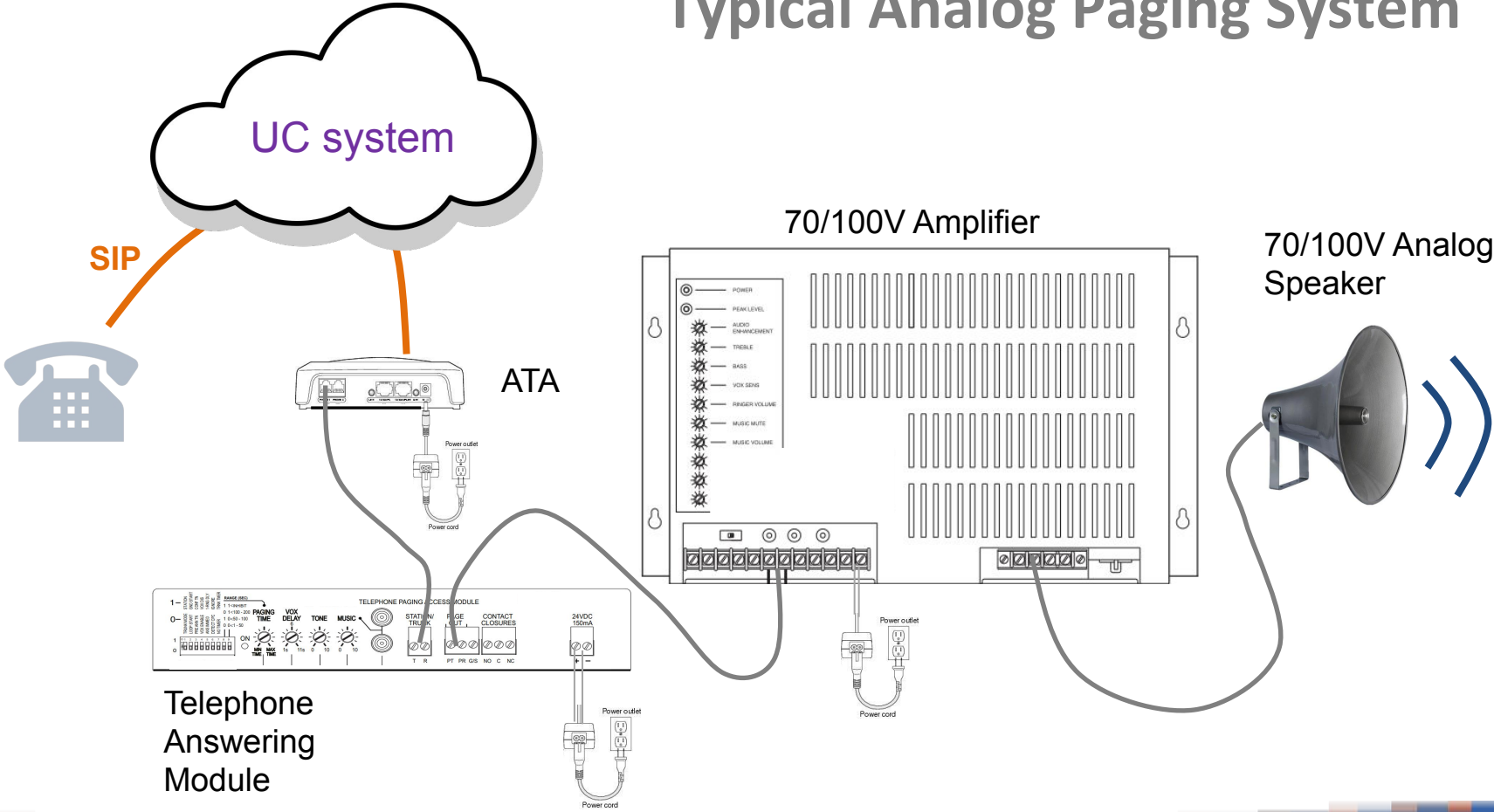

IP Enabled Analog Paging System

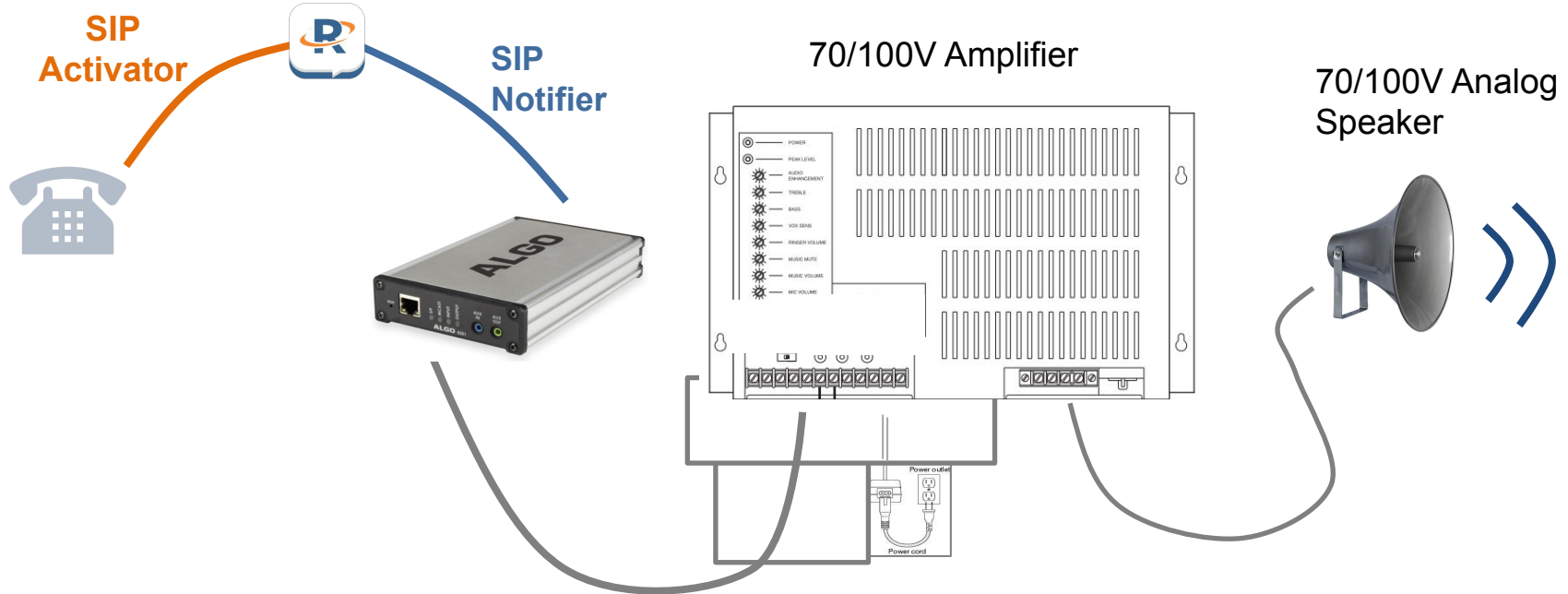

Paging With IP Speakers



- PoE network speaker
- Microphone (Ambient and Talkback)
- HTTPS Web configuration
- Memory for Audio WAV Files
- Page zone & volume easily adjusted
- Delayed page for feedback
- Secure SIP TLS & SRTP

Multiple networked amplifiers

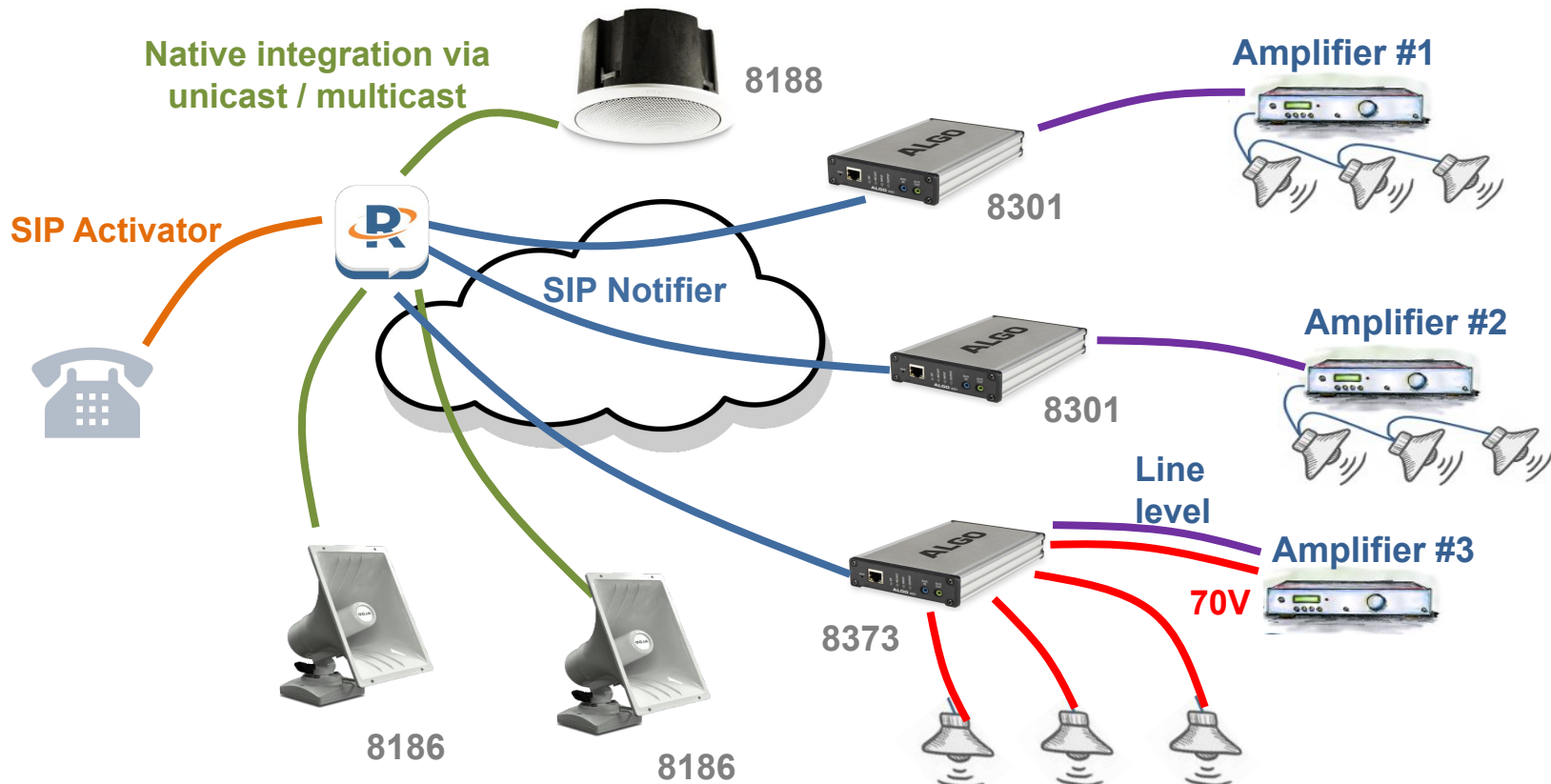



8128G2

Upgraded processor

Firmware v1.7

TLS, SIPS, SRTP, Mutual Authentication

LLDP/CDP

25% brighter than current 8128



8138

Same product as 8128

Equipped with red, blue, amber and green





Video



Video





Mass Notification Solutions

- ❑ Adverse weather approaches and mass notification system receives an alert from the weather service which triggers an emergency procedure for the workers in the plant.
- ❑ Algo LED strobe lights flash red.
- ❑ Algo Horn Speakers play emergency alert tone
- ❑ Mass notification system sends alerts to mobile devices with emergency message e.g. "Tornado warning."
- ❑ Operators can quickly take shelter.
- ❑ Multicast scalable to many Algo devices.
- ❑ Emergency is over mass notification solution triggers green flash pattern with all clear message played.

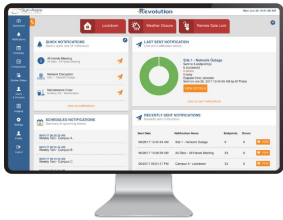

Revolution
Mass Notification System

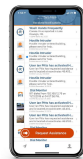

"Mobile"



"EMERGENCY!"



"All Clear"



"Loud Alerting"

Activation Methods

- | | |
|---|---|
| 
Revolution UI | 
Revolution Mobile App |
| 
IP Buttons | 
NWS CAP Activator |
| 
Desktop Phone | 
Fire Alarm Panel |
| 
Revolution Scheduler | 
IPAWS EAS Activator |
| 
Revolution CAP Activator | 
Revolution AMBER Alert Activator |
| 
Collaboration Tools | 
Email Activator |
| 
Input Audio Stream | 
911 Dial Monitor |
| 
Status Activator | 
Cloud API (Third Party) |
| 
Revolution API | 
SNMP |

Revolution



ALGO 

CONTACT US

www.algosolutions.com

www.syn-apps.com

www.voipsupply.com



Algo Communication Products Ltd.

4500 Beedie Street
Burnaby, B.C. Canada V5J 5L2



Syn-Apps LLC

1022 SW Salmon St. Suite 470
Portland, OR 97205



VoIP Supply

80 Pineview Dr.
Amherst, NY 14228

CONNECT WITH US!

