

**SAFETY**  
SHIELDS



# SAFETY SHIELDS FOR COUNTERTOPS



Create a safety barrier between you and your customers with TableCraft's new Safety shields.

- Perfect for counter service, in front of POS counters, pick up, or host stations
- Units require no extra hardware or drilling required
- Freestanding units are available in 30" and 36" widths
- Pass throughs and other customizations are available. Contact your TableCraft sales representative
- 1/4" acrylic provides excellent clarity, cleanability and durability

Item #	Description	Min Order/ Case Pack	List Price (\$)
<b>SAFETY SHIELD</b>			
a. CWACR30	Freestanding Countertop Shield, 30 x 32 x 1/4"	1 ea / 1 ea	270.00 ea
b. CWACR36	Freestanding Countertop Shield, 36 x 32 x 1/4"	1 ea / 1 ea	290.00 ea

Custom styles and sizes available. Contact your TableCraft Rep for a quote.

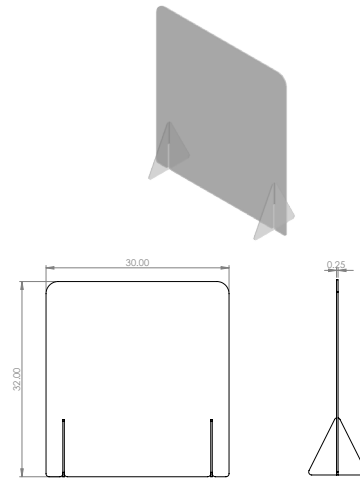

Case wt./cube: 9.6 lbs., 5.2 cu. ft.



A 30 x 32 x 1/4" FREESTANDING COUNTERTOP SAFETY SHIELD #CWACR30

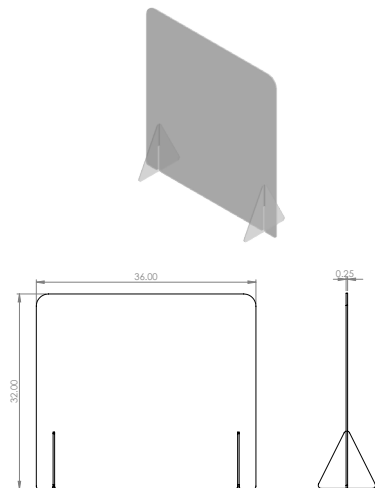

Case wt./cube: 10.95 lbs., 5.2 cu. ft.

B 36 x 32 x 1/4" FREESTANDING COUNTERTOP SAFETY SHIELD #CWACR36

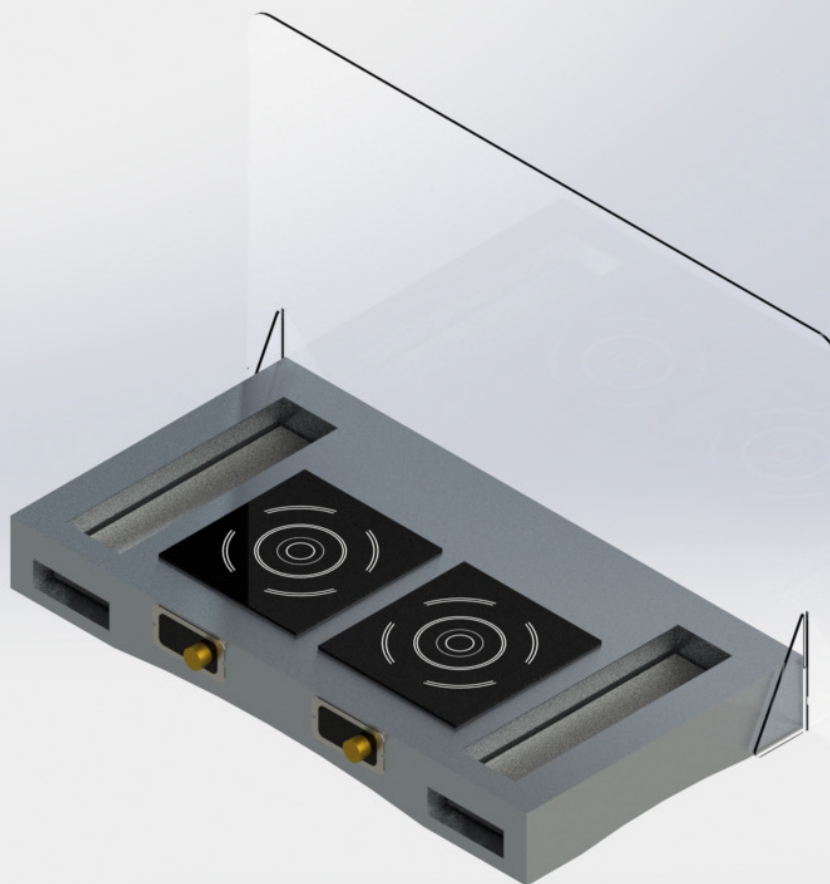

## SAFETY SHIELD STANDS FOR ACTION STATIONS

Create a safety barrier between servers and patrons with TableCraft's Action Station Safety shields

- freestanding units are sized to fit CWACTION1 or CWACTION2
- integrated venting helps keep induction cook-top cool during use
- 1/4" acrylic provides excellent clarity, cleanability and durability

**A SINGLE ACTION STATION SHIELD #CWACT1SHIELD**

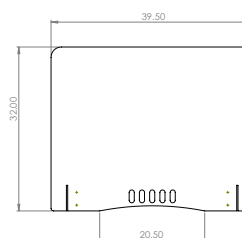

Case wt./cube: 24 lbs., 4.03 cu. ft.

**B DOUBLE ACTION STATION SHIELD #CWACT2SHIELD**

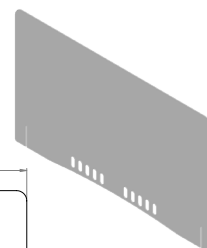
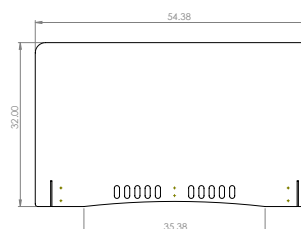

Case wt./cube: 30 lbs., 5.50 cu. ft.

Item #	Description	Min Order/ Case Pack	List Price (\$)
<b>SAFETY SHIELD STANDS</b>			
a.	CWACT1SHIELD Single Action Station Shield, 39½ x 32 x ¼"	1 ea / 1 ea	294.00 ea
b.	CWACT2SHIELD Double Action Station Shield, 54 <sup>2</sup> / <sub>5</sub> x 32 x ¼"	1 ea / 1 ea	369.00 ea

Custom styles and sizes available. Contact your TableCraft Rep for a quote.

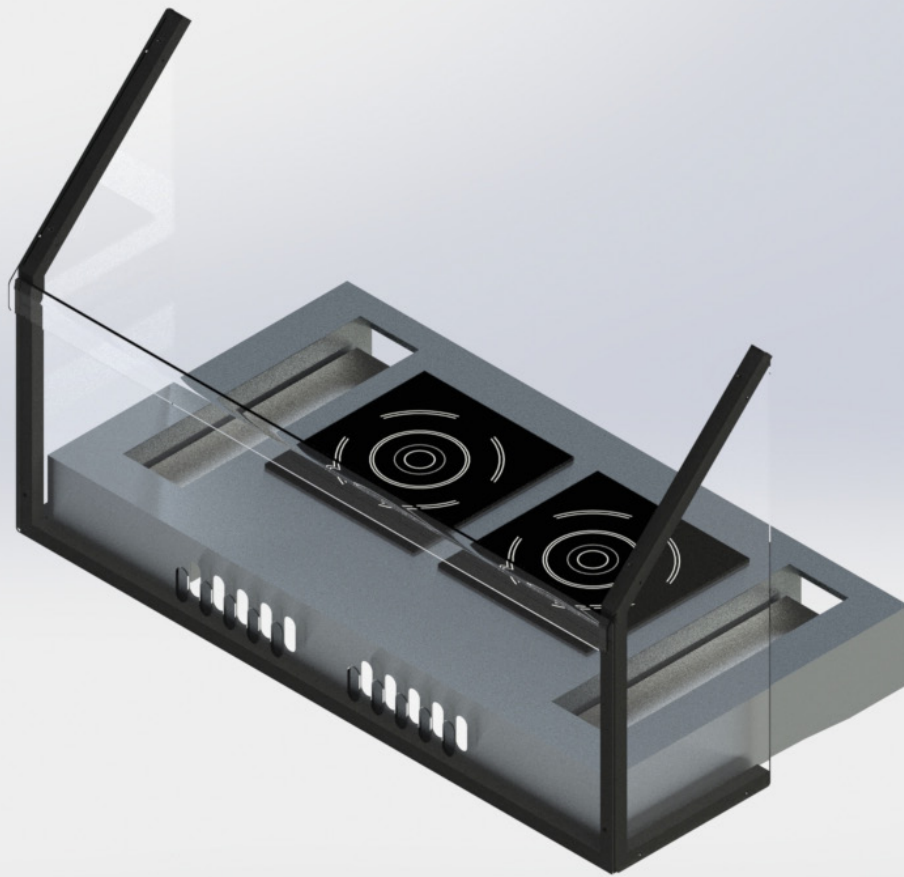

## SAFETY SHIELD WITH FRAME FOR ACTION STATIONS

Create a safety barrier between servers and patrons with TableCraft's Action Station Safety shields

- freestanding units are sized to fit CWACTION1 or CWACTION2
- metal frame provides added stability and increased durability
- integrated venting helps keep induction cook-top cool during use
- 1/4" acrylic provides excellent clarity, cleanability and durability
- assembly required

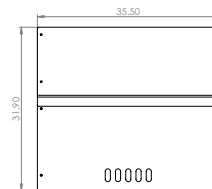

**A SINGLE ACTION STATION SHIELD WITH FRAME**  
#CWACT1FSHIELD

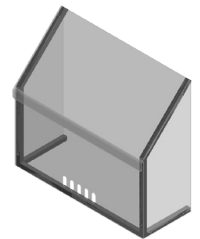
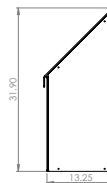

Case wt./cube: 22 lbs., 12.59 cu. ft.

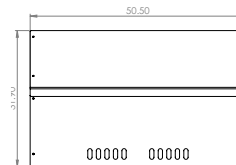

**B DOUBLE ACTION STATION SHIELD WITH FRAME**  
#CWACT2FSHIELD

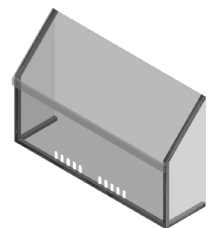
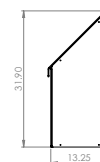

Case wt./cube: 26 lbs., 18 cu. ft.

Item #	Description	Min Order/ Case Pack	List Price (\$)
<b>SAFETY SHIELD WITH FRAME</b>			
a.	CWACT1FSHIELD Single Action Station Shield w/Frame, 35½ x 31 <sup>9</sup> / <sub>10</sub> x 13¼"	1 ea / 1 ea	520.00 ea
b.	CWACT2FSHIELD Double Action Station Shield w/Frame, 50½ x 31 <sup>9</sup> / <sub>10</sub> x 13¼"	1 ea / 1 ea	690.00 ea

Custom styles and sizes available. Contact your TableCraft Rep for a quote.



# CAFETERIA SAFETY SHIELDS

## FOR CAFETERIA SEATING

Create a safety barrier between patrons in communal and cafeteria seating areas with TableCraft's cafeteria dividers

- freestanding units are sized to fit most standard cafeteria tables or benches
- 1/4" acrylic provides excellent clarity, cleanability and durability
- custom sizes are available; contact your TableCraft sales representative

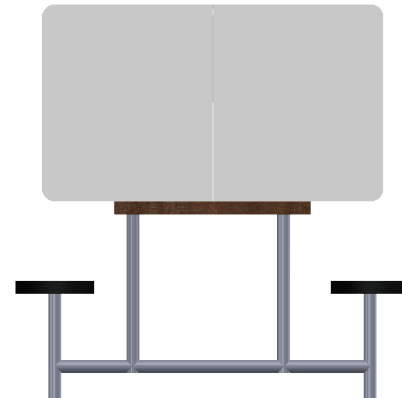
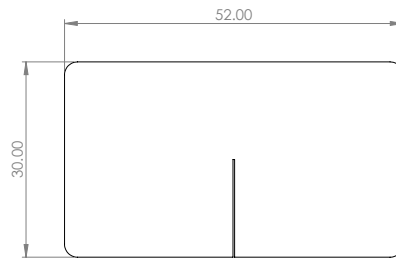

WIDTH

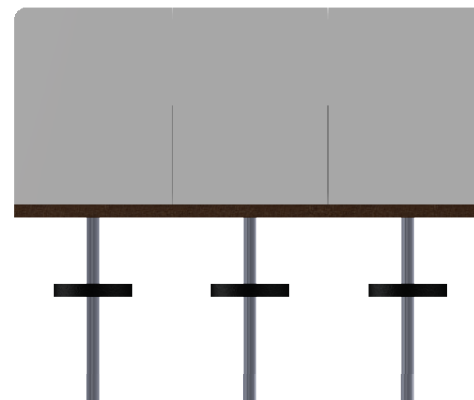
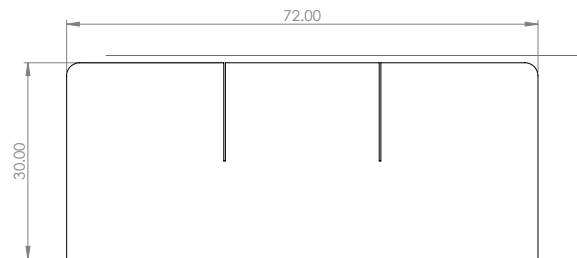

LENGTH

Item #	Description	Min Order/ Case Pack	List Price (\$)
<b>CAFETERIA SHIELDS</b>			
CWACRT72	Cafeteria Safety Shield, 72 x 24 x 1/4"	1 ea / 1 ea	1326.00 ea
Custom styles and sizes available. Contact your TableCraft Rep for a quote.			



CAFETERIA SAFETY SHIELD #CWACRT72



# BOOTH SAFETY SHIELDS

## FOR BOOTH SEATING

Create additional safety barriers between customers with TableCraft's Booth seating dividers.

- Sized to fit standard 48" deep booths
- Custom sizes are also available. Contact your TableCraft sales representative
- 1/4" acrylic provides excellent clarity, cleanability and durability
- mounting hardware included
- assembly required

Item #	Description	Min Order/ Case Pack	List Price (\$)
<b>BOOTH SHIELDS</b>			
CWACRB48	Booth Safety Shield, 48 x 30 x 1/4"	1 ea / 1 ea	426.40 ea
Custom styles and sizes available. Contact your TableCraft Rep for a quote.			

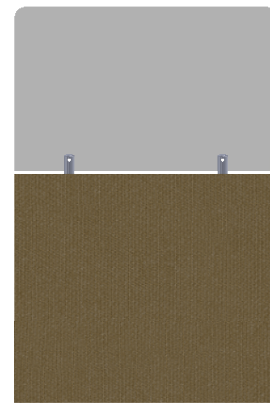
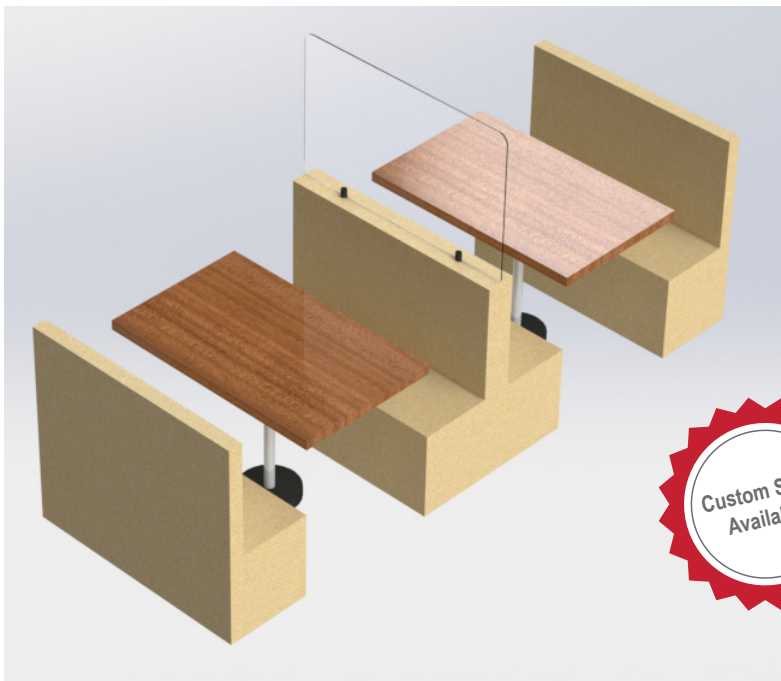
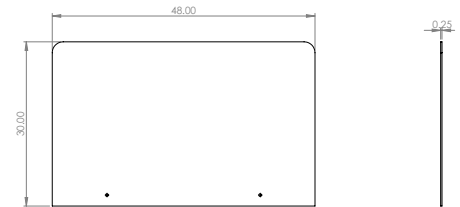

BOOTH SAFETY SHIELD #CWACRB48

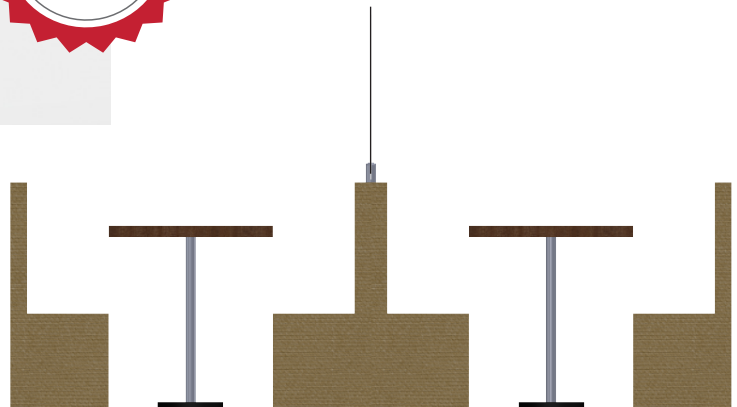

Buffet, Catering & Display | Beverage & Countertop | Tabletop Solutions | Serving Solutions | Bar Solutions | Squeeze Bottles | Kitchen Tools & Food Prep  
 To find your local sales representative visit [www.tablecraft.com](http://www.tablecraft.com) or call our customer service hotline at **800.323.8321** Ships from Gurnee, IL 60031

Follow us on social media:

