

dapple
BY INSOL



The dapple story

Introducing dapple

Developed by Insol, the experts in architectural screening and facades, dapple is an extraordinary range of perforated sheet metal.

Thoughtfully designed, each pattern showcases a choreography of light, performed by deep shadows and dancing sunlight. The effect is entrancing and ever-changing.

“More and more, so it seems to me, light is the beautifier of the building.”

FRANK LLOYD WRIGHT



The dapple difference

It's tested

Dapple is mostly used outside. Privacy screens. Sun screens. Or just architectural x-factor.

When it gets windy, some holes whistle. Not the simple whistling of a happy child but an annoying, penetrating whistle that causes you to grit your teeth.

We can tell you which holes whistle, when they whistle, and how loud. We can tell you where you should, or should not, put each pattern.

dapple patterns are wind-tunnel tested in the Insol Facade Testing Laboratory. Each pattern is assigned a performance rating for your comfort and assurance.

Wind rating system

Everything makes noise in the wind

It becomes a case of knowing how annoying the noise will be and how likely it is to happen. Our research has led to the development of a matrix which quantifies the risk of wind noise issues. It classifies the probability of noise and associated level of annoyance.

		PROBABILITY OF WIND GUST			
		A 108Km/h +	B 90-108Km/h	C 54-90Km/h	D 0-54Km/h
ANNOYANCE	1	●	●	●	●
	2	●	●	▲	■
	3	●	▲	▲	■
	4	▲	■	■	◆

- 1 *Unnoticeable above background noise*
- 2 *Tolerable above background noise*
- 3 *Irritating*
- 4 *Intolerable*

- *Very low risk of generating noise. Suitable for use over 10m high and around building edges.*
- ▲ *Avoid using near building edges or anywhere there is free air flow through the screen. Seek advice before using over 10m height.*
- *Do not use over 10m, near building edges, or anywhere there is free air flow through the screen. Seek advice regarding positioning.*
- ◆ *Ground level and interior use only.*



**daple
patterns**

Variations in shape, open area and available finishes are offered in an extended and extraordinary range of perforated sheet metal.

Every pattern is designed, developed and wind tested by Insol, in New Zealand.

If you can't see what you want here, just ask. We are continually developing and testing more patterns.



Daylight

Specifications

Material	3mm 5005 grade Aluminium
Finishes available	Powdercoat or Anodised
Standard width*	1200mm
Standard length*	2400mm
Open Area	41.10%
Weight Kg/m ²	4.81
Wind noise rating†	●

* Larger custom widths and lengths available

† See page 4

Pattern shown at actual size

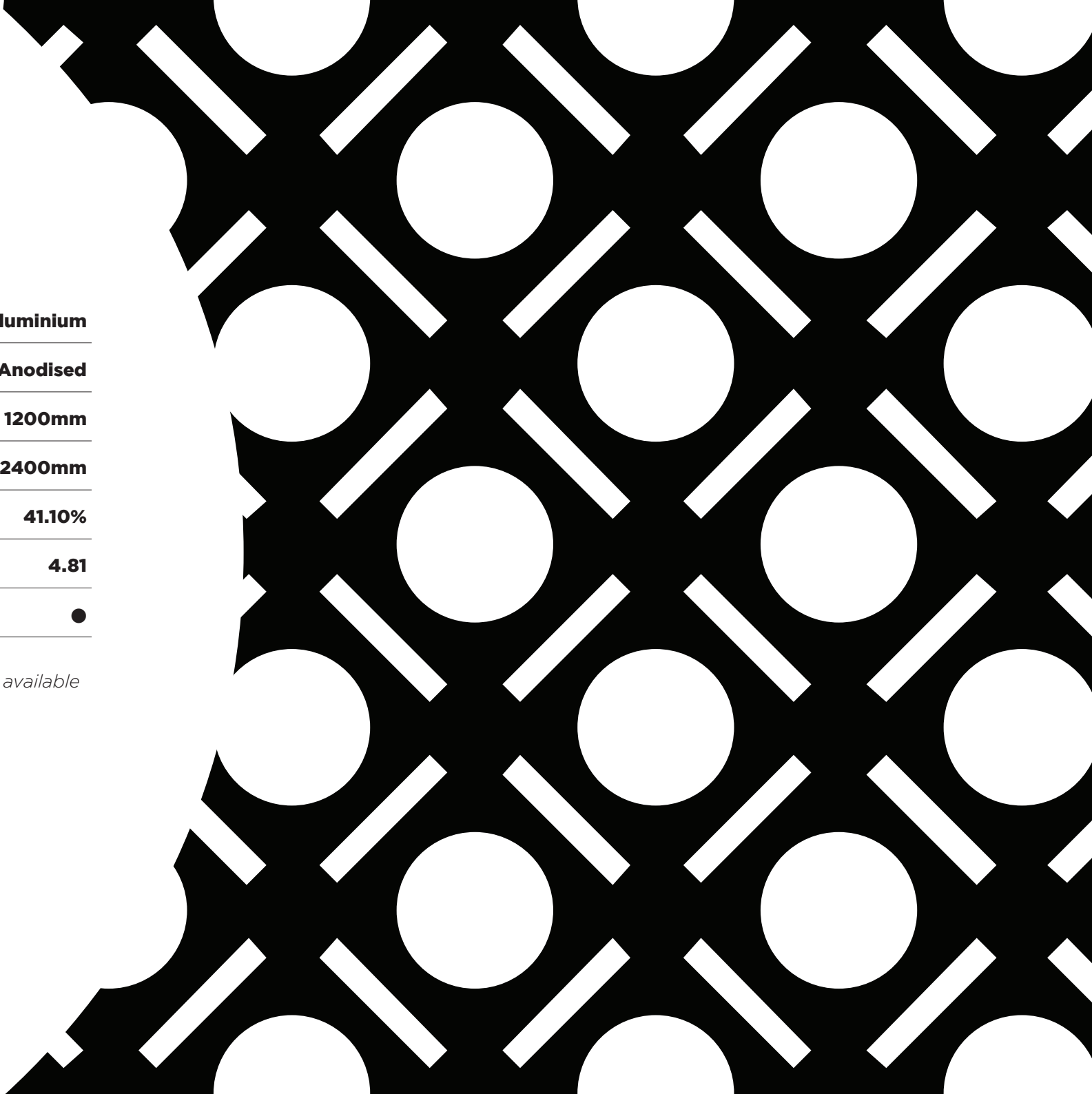



Twilight

Specifications

Material	3mm 5005 grade Aluminium
Finishes available	Powdercoat or Anodised
Standard width*	1200mm
Standard length*	2400mm
Open Area	26.67%
Weight Kg/m ²	5.96
Wind noise rating†	●

* Larger custom widths and lengths available

† See page 4

Pattern shown at actual size



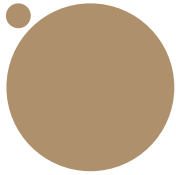

Sunrise

Specifications

Material	3mm 5005 grade Aluminium
Finishes available	Powdercoat or Anodised
Standard width*	1200mm
Standard length*	2400mm
Open Area	46.21%
Weight Kg/m ²	4.37
Wind noise rating†	■

* Larger custom widths and lengths available

† See page 4

Pattern shown at actual size

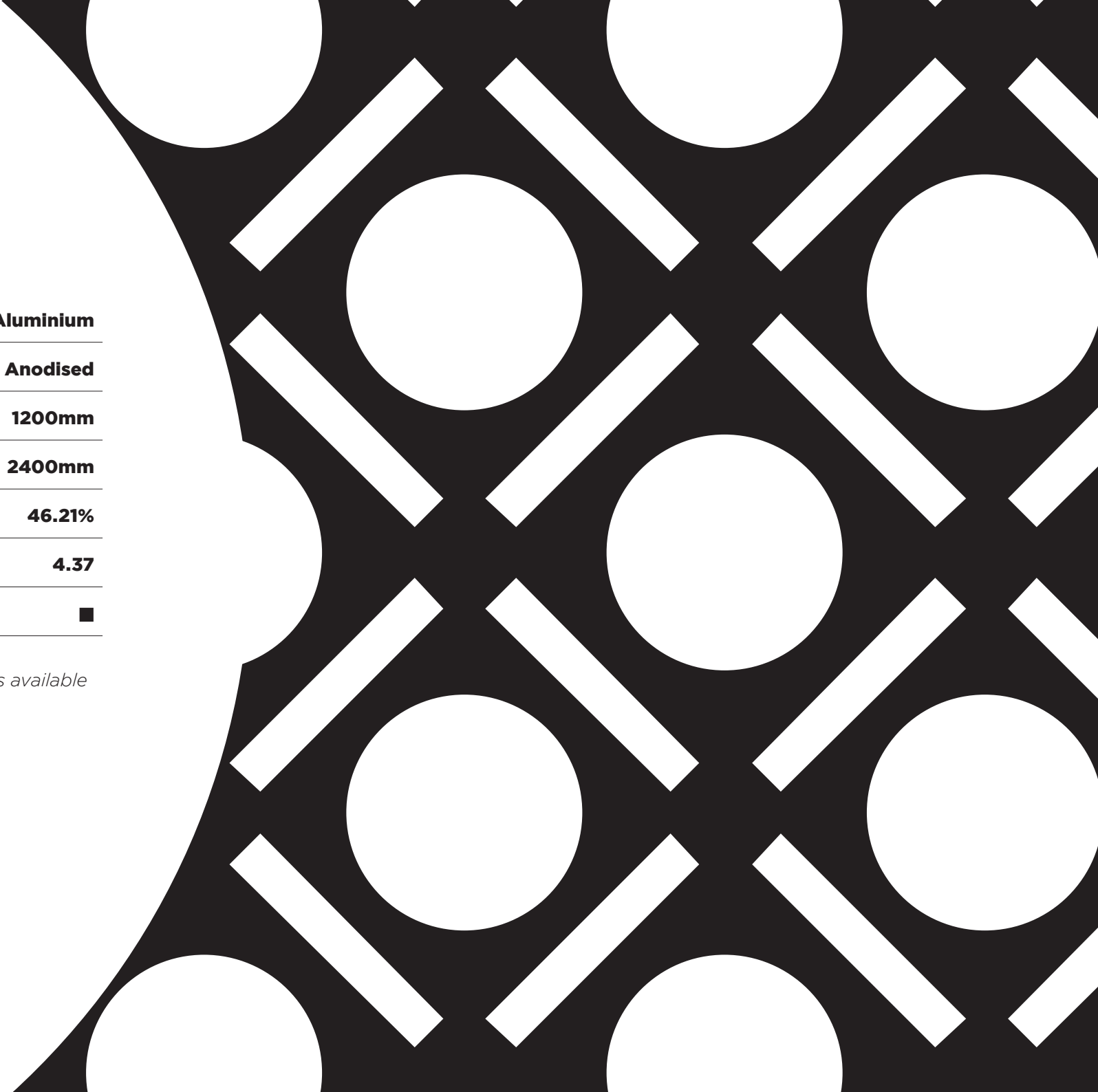

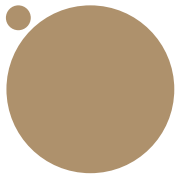

Sunset

Specifications

Material	3mm 5005 grade Aluminium
Finishes available	Powdercoat or Anodised
Standard width*	1200mm
Standard length*	2400mm
Open Area	30.30%
Weight Kg/m ²	5.67
Wind noise rating†	●

* Larger custom widths and lengths available

† See page 4

Pattern shown at actual size





Lichfield Street Car Park, Christchurch

Architect MAP Architects

Construction Clearwater Construction

Details Custom, aluminium diamond-shaped 'scales' combine with translucent red polycarbonate panels to produce moving shadows and light, adding an element of drama and capturing your attention.

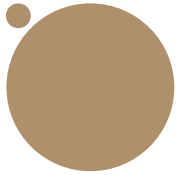

Dusk

Specifications

Material	3mm 5005 grade Aluminium
Finishes available	Powdercoat or Anodised
Standard width*	1200mm
Standard length*	2400mm
Open Area	52.13%
Weight Kg/m ²	4.12
Wind noise rating†	▲

* Larger custom widths and lengths available

† See page 4

Pattern shown at actual size

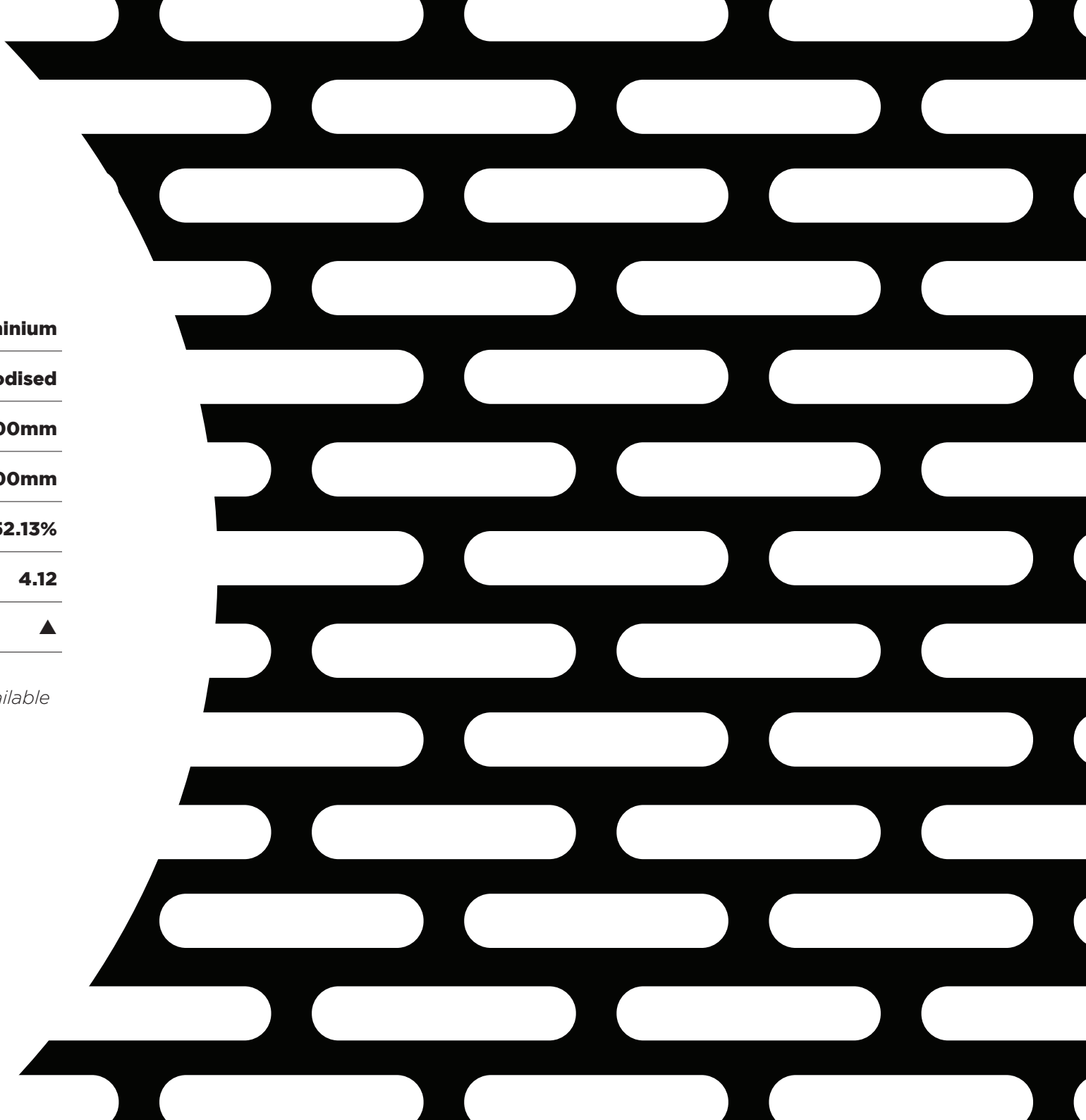

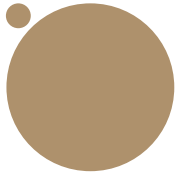

Light Glow

Specifications

Material	3mm 5005 grade Aluminium
Finishes available	Powdercoat or Anodised
Standard width*	1200mm
Standard length*	2400mm
Open Area	58.46%
Weight Kg/m ²	3.38
Wind noise rating†	▲

** Larger custom widths and lengths available*

† See page 4

Pattern shown at actual size

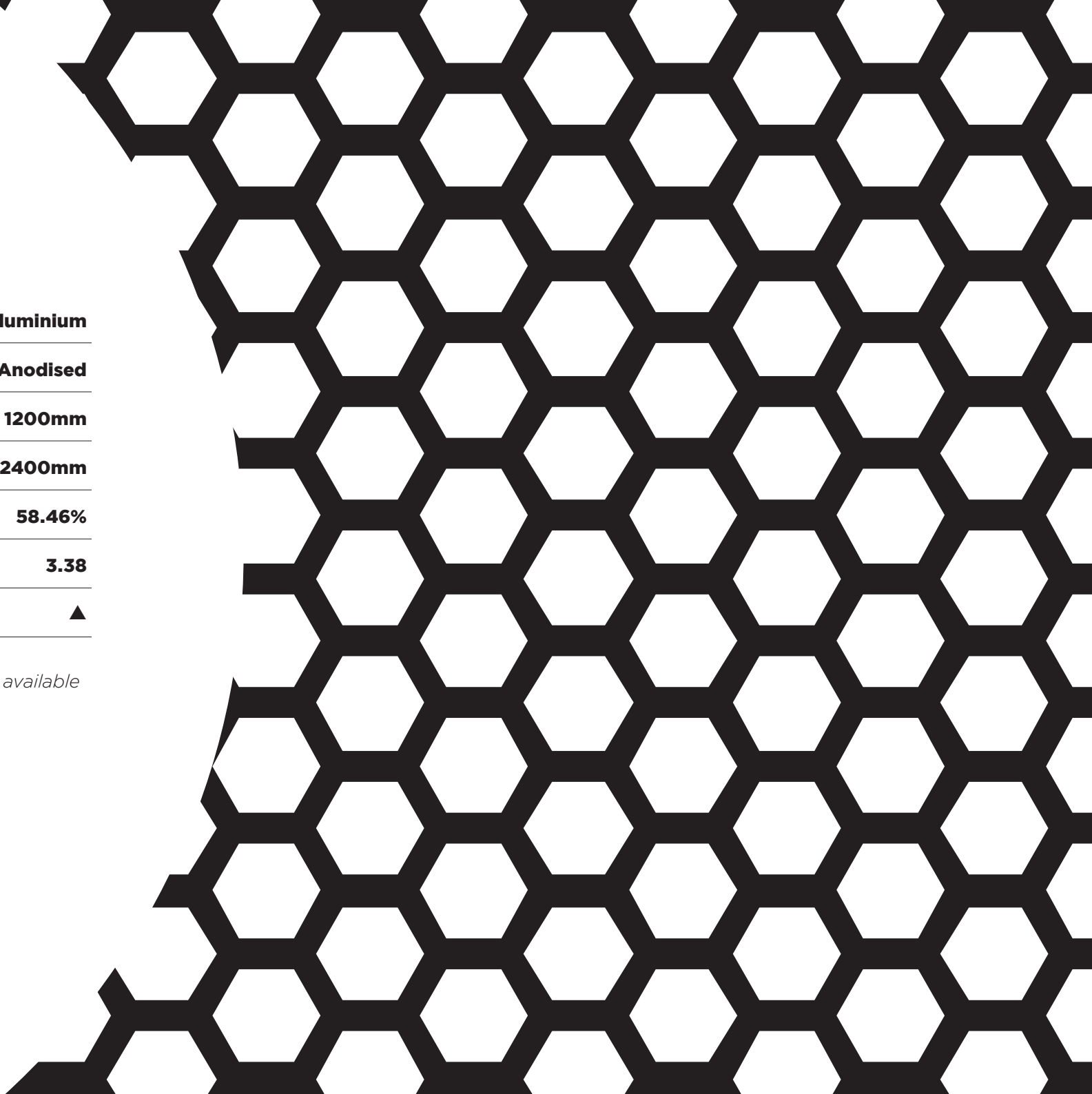

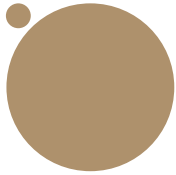

Light Beam

Specifications

Material	3mm 5005 grade Aluminium
Finishes available	Powdercoat or Anodised
Standard width*	1200mm
Standard length*	2400mm
Open Area	62.07%
Weight Kg/m ²	3.08
Wind noise rating†	●

* Larger custom widths and lengths available

† See page 4

Pattern shown at actual size

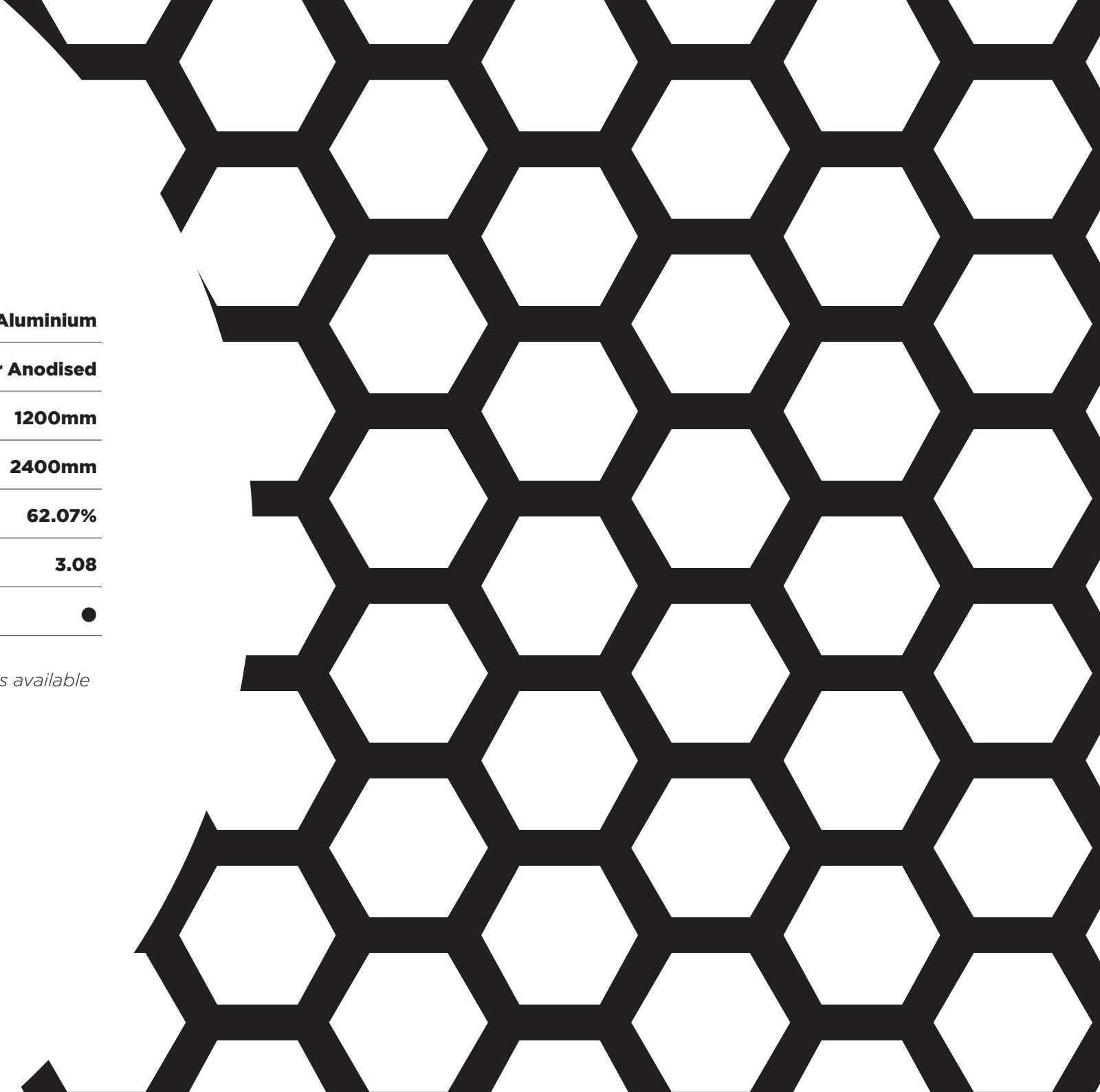



Starlight

Specifications

Material	3mm 5005 grade Aluminium
Finishes available	Powdercoat or Anodised
Standard width*	1200mm
Standard length*	2400mm
Open Area	55.65%
Weight Kg/m ²	3.61
Wind noise rating†	▲

* Larger custom widths and lengths available

† See page 4

Pattern shown at actual size

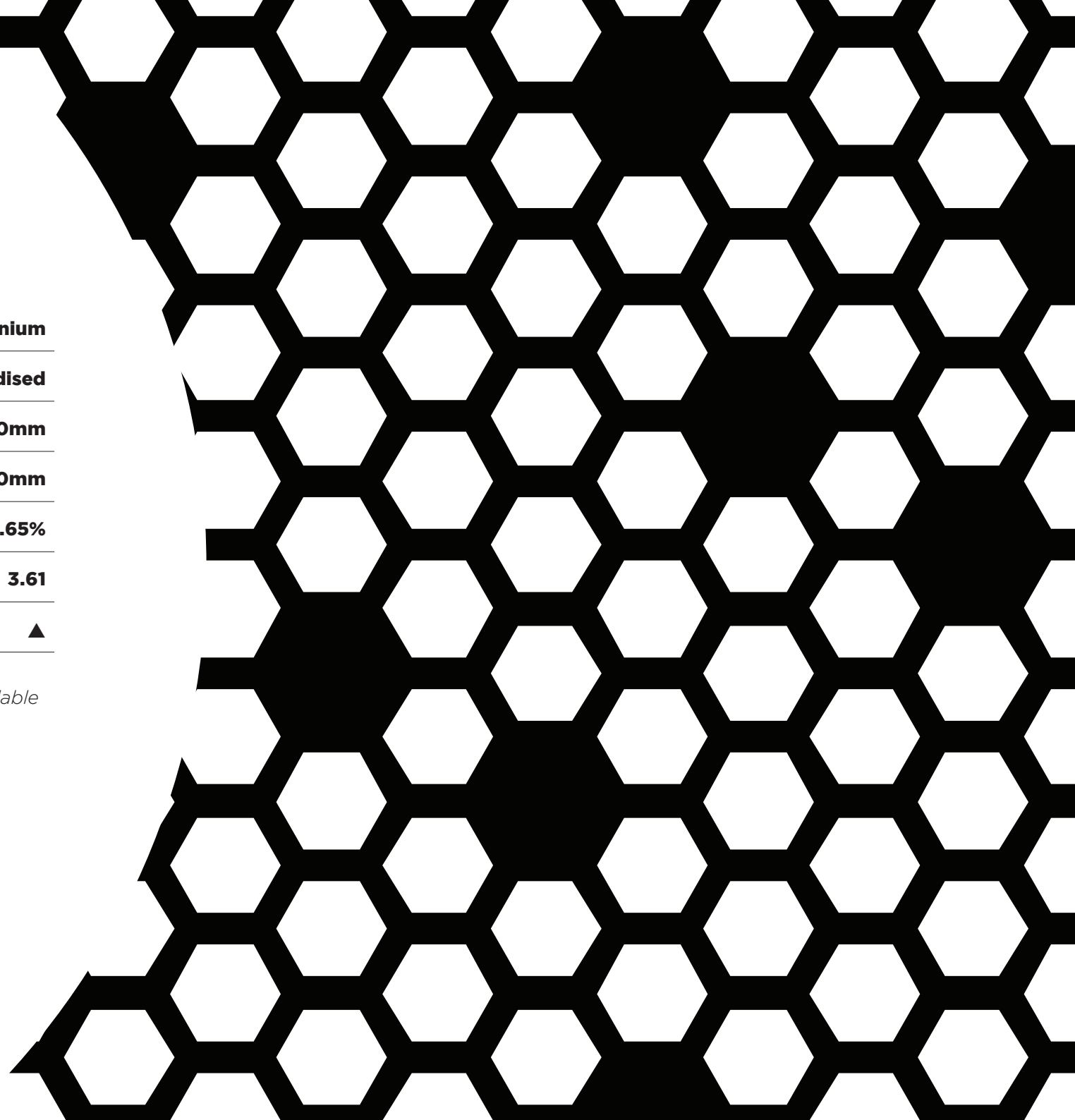



Les Mills Car Park, Auckland

Architect Warren & Mahoney

Contractor Leighs Construction

Details A three-dimensional diamond pattern, interspersed with bronze tinted vision panels, looks different from every angle. At night, the light shines through to create a facade that sparkles like a clear night sky.

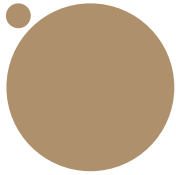

Lamp Light

Specifications

Material	3mm 5005 grade Aluminium
Finishes available	Powdercoat or Anodised
Standard width*	1200mm
Standard length*	2400mm
Open Area	57.40%
Weight Kg/m ²	3.46
Wind noise rating†	▲

* Larger custom widths and lengths available

† See page 4

Pattern shown at actual size

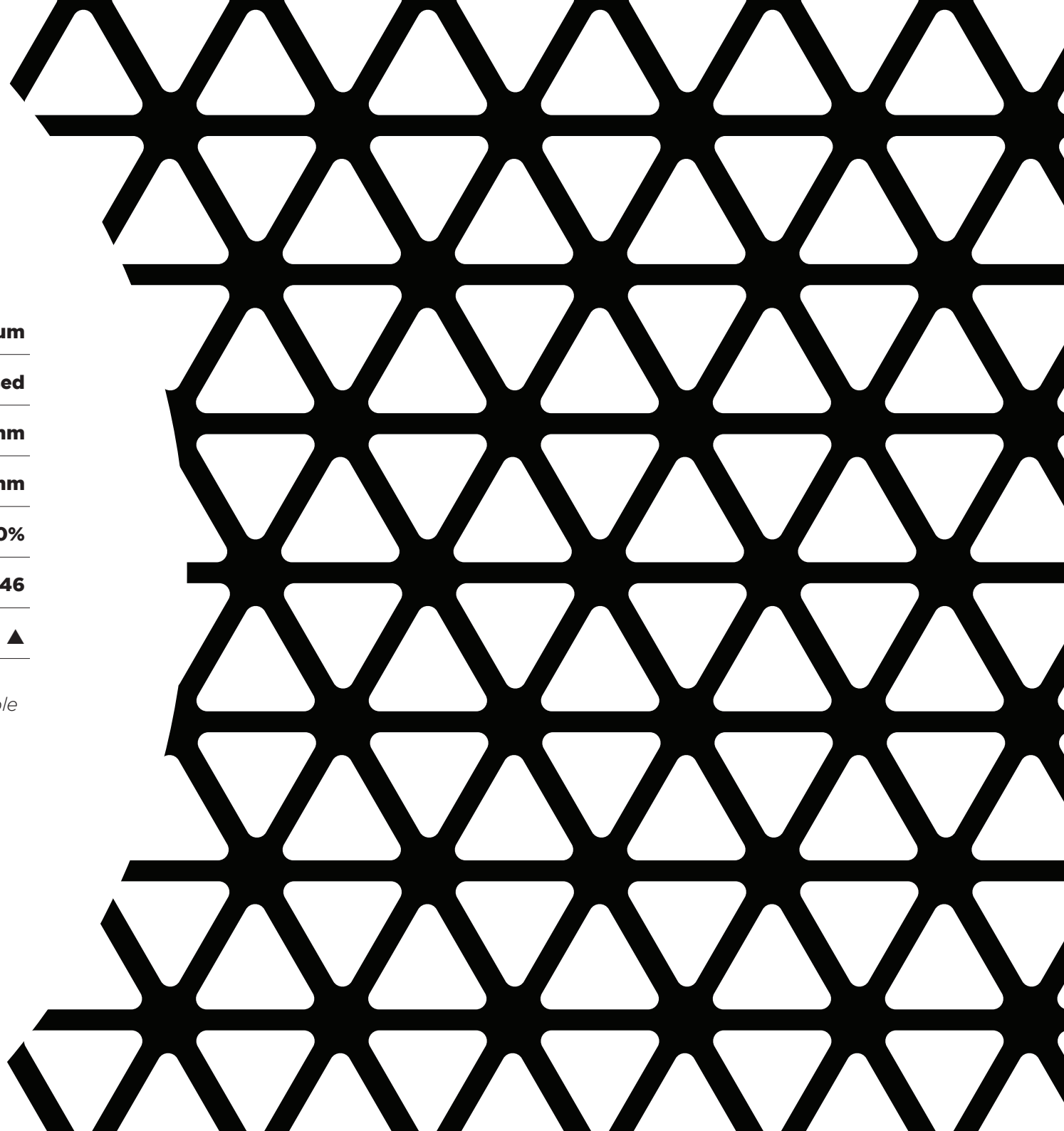

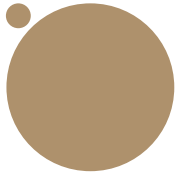

Limelight

Specifications

Material	3mm 5005 grade Aluminium
Finishes available	Powdercoat or Anodised
Standard width*	1200mm
Standard length*	2400mm
Open Area	50.26%
Weight Kg/m ²	4.04
Wind noise rating†	▲

** Larger custom widths and lengths available*

† See page 4

Pattern shown at actual size

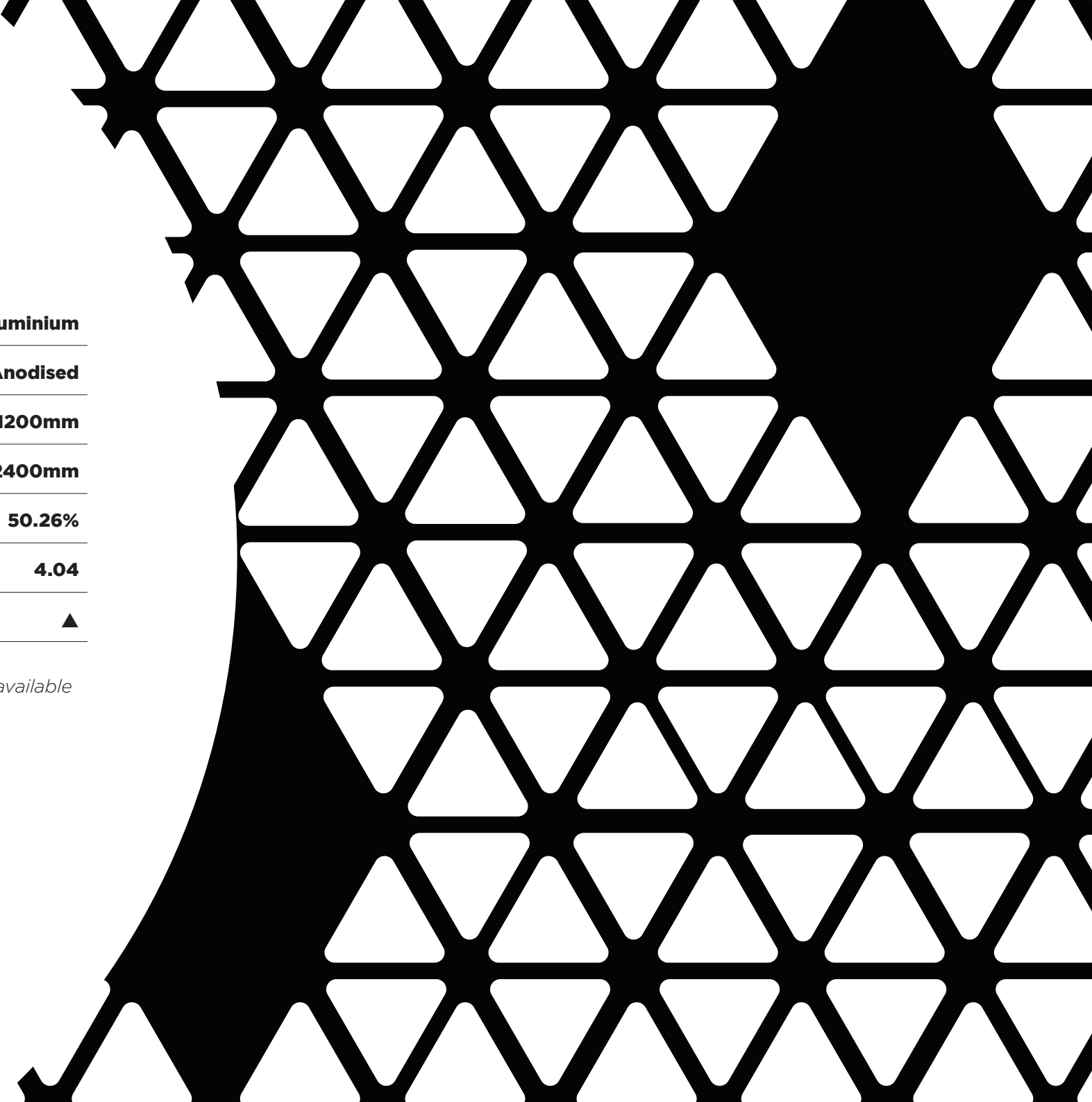

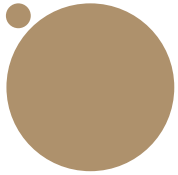

Moonlight

Specifications

Material	3mm 5005 grade Aluminium
Finishes available	Powdercoat or Anodised
Standard width*	1200mm
Standard length*	2400mm
Open Area	52.05%
Weight Kg/m ²	3.90
Wind noise rating†	▲

* Larger custom widths and lengths available

† See page 4

Pattern shown at actual size

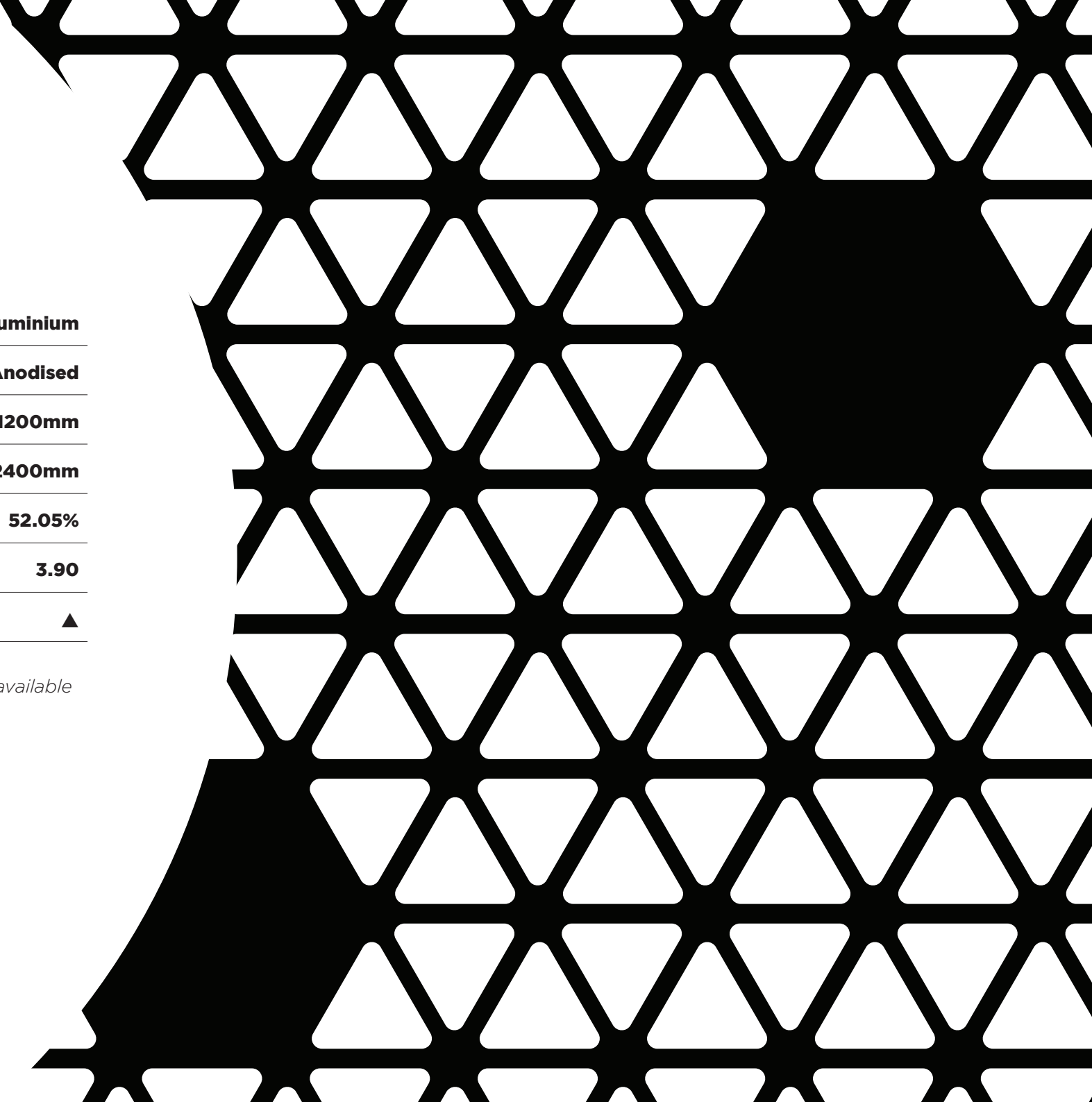

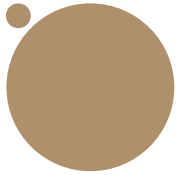

Moonspell

Specifications

Material	3mm 5005 grade Aluminium
Finishes available	Powdercoat or Anodised
Standard width*	1200mm
Standard length*	2400mm
Open Area	60.60%
Weight Kg/m ²	5.67
Wind noise rating†	▲

** Larger custom widths and lengths available*

† See page 4

Pattern shown at actual size

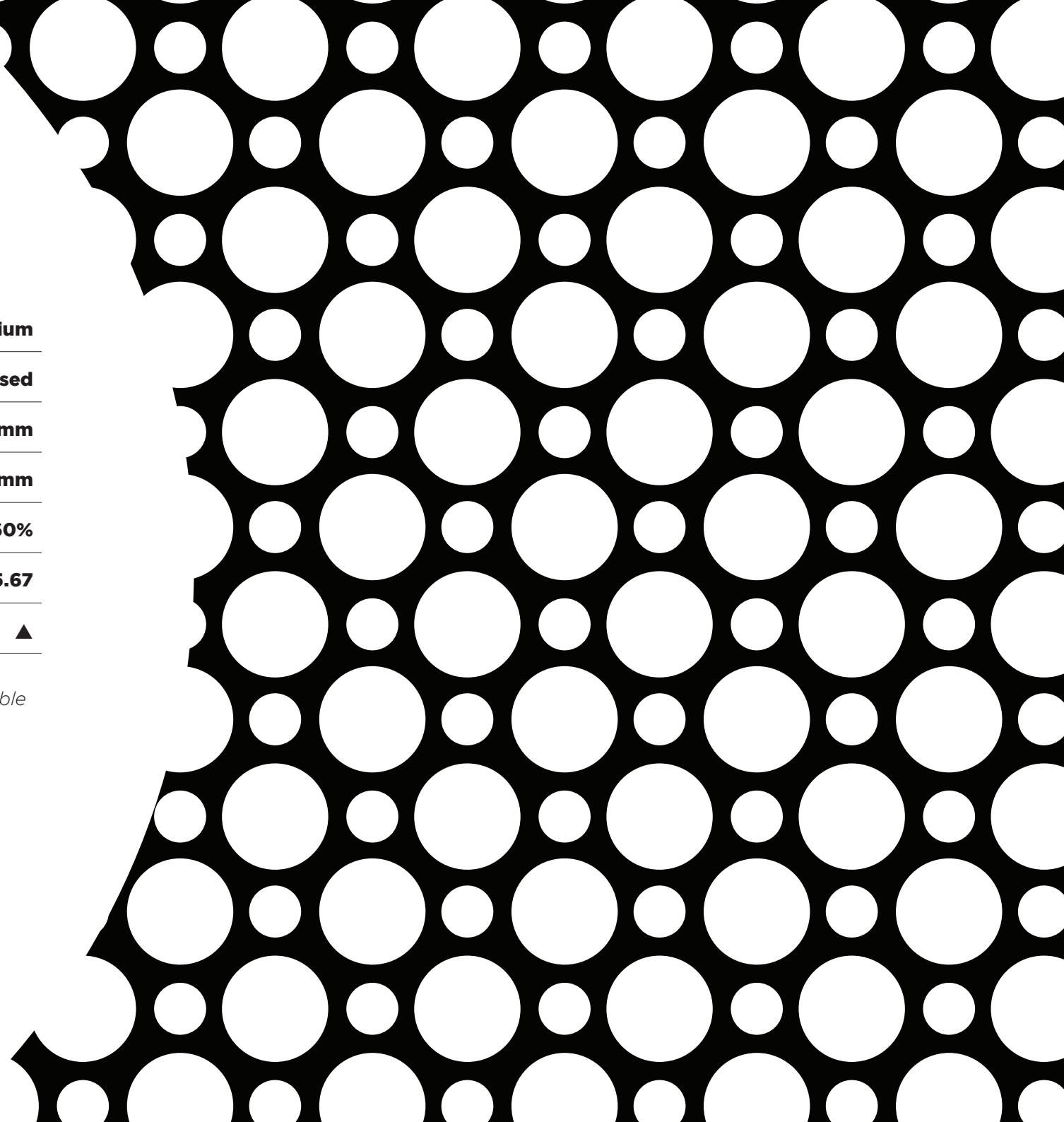



Crave Cafe, Auckland

Architect Colab Construction

Construction Colab Construction

Details Perforated metal is used to upscale the appearance of a tired 1980's design, adding appeal and value by capturing light and attention in equal measure.

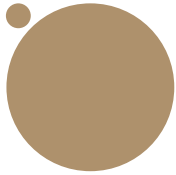

Moonscape

Specifications

Material	3mm 5005 grade Aluminium
Finishes available	Powdercoat or Anodised
Standard width*	1200mm
Standard length*	2400mm
Open Area	30.20%
Weight Kg/m ²	3.46
Wind noise rating†	●

* Larger custom widths and lengths available

† See page 4

Pattern shown at actual size



Light Speck

Specifications

Material	3mm 5005 grade Aluminium
Finishes available	Powdercoat or Anodised
Standard width*	1200mm
Standard length*	2400mm
Open Area	35.43%
Weight Kg/m ²	5.64
Wind noise rating†	◆

* Larger custom widths and lengths available

† See page 4

Pattern shown at actual size



Light Touch

Specifications

Material	3mm 5005 grade Aluminium
Finishes available	Powdercoat or Anodised
Standard width*	1200mm
Standard length*	2400mm
Open Area	35.00%
Weight Kg/m ²	5.67
Wind noise rating†	▲

** Larger custom widths and lengths available*

† See page 4

Pattern shown at actual size

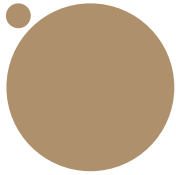

Light Rain

Specifications

Material	3mm 5005 grade Aluminium
Finishes available	Powdercoat or Anodised
Standard width*	1200mm
Standard length*	2400mm
Open Area	49.05%
Weight Kg/m ²	4.68
Wind noise rating†	▲

* Larger custom widths and lengths available

† See page 4

Pattern shown at actual size

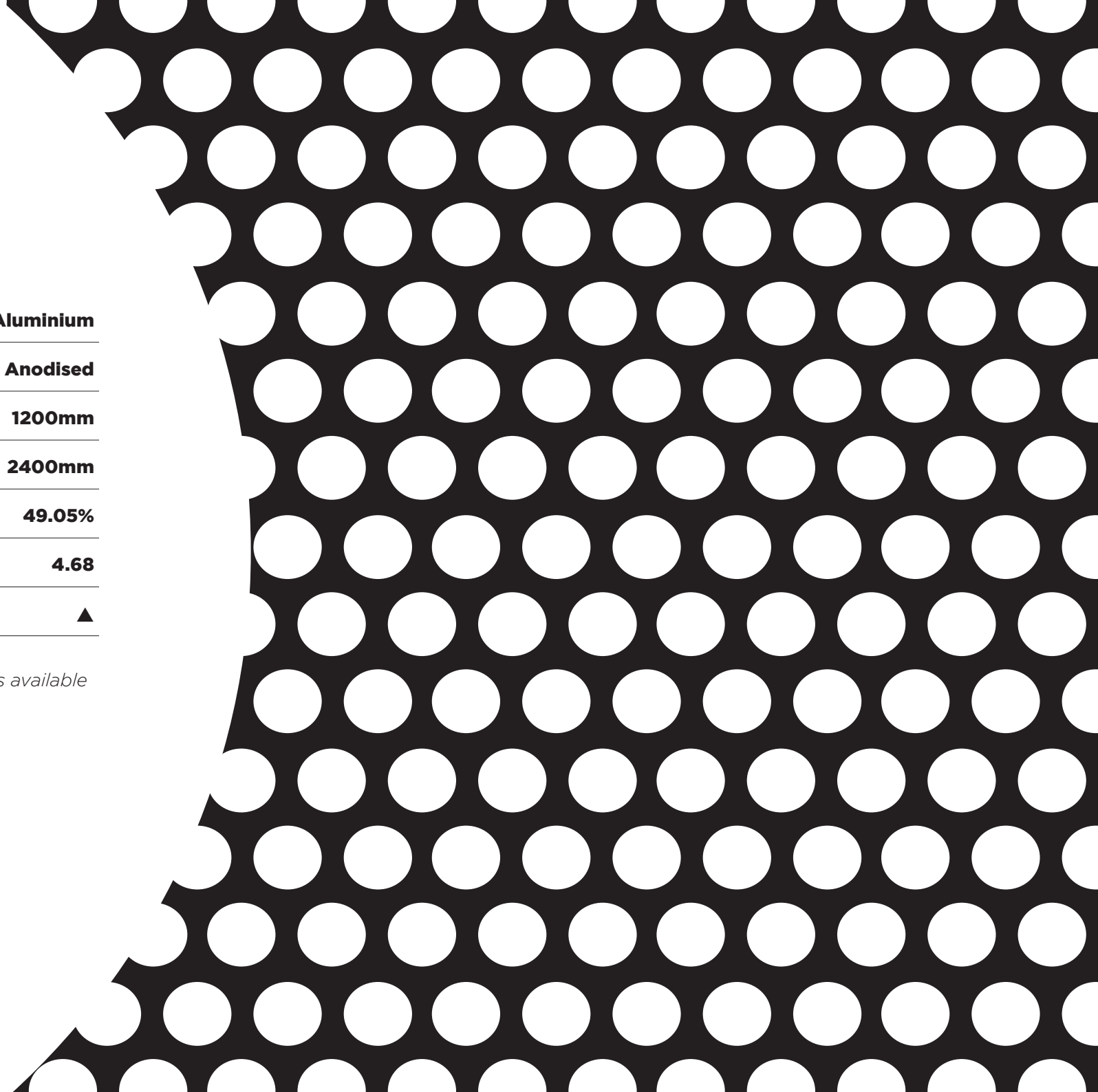



Langdons Road, Christchurch

Architect Babbage Consultants

Construction Westmore Construction

Details A custom dapple pattern of organic forms creates a spreading growth of light and shadows, adding life and a moving canvas on the building exterior.



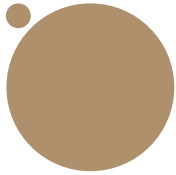

Light Burst

Specifications

Material	3mm 5005 grade Aluminium
Finishes available	Powdercoat or Anodised
Standard width*	1200mm
Standard length*	2400mm
Open Area	51.01%
Weight Kg/m ²	4.54
Wind noise rating†	▲

* Larger custom widths and lengths available

† See page 4

Pattern shown at actual size

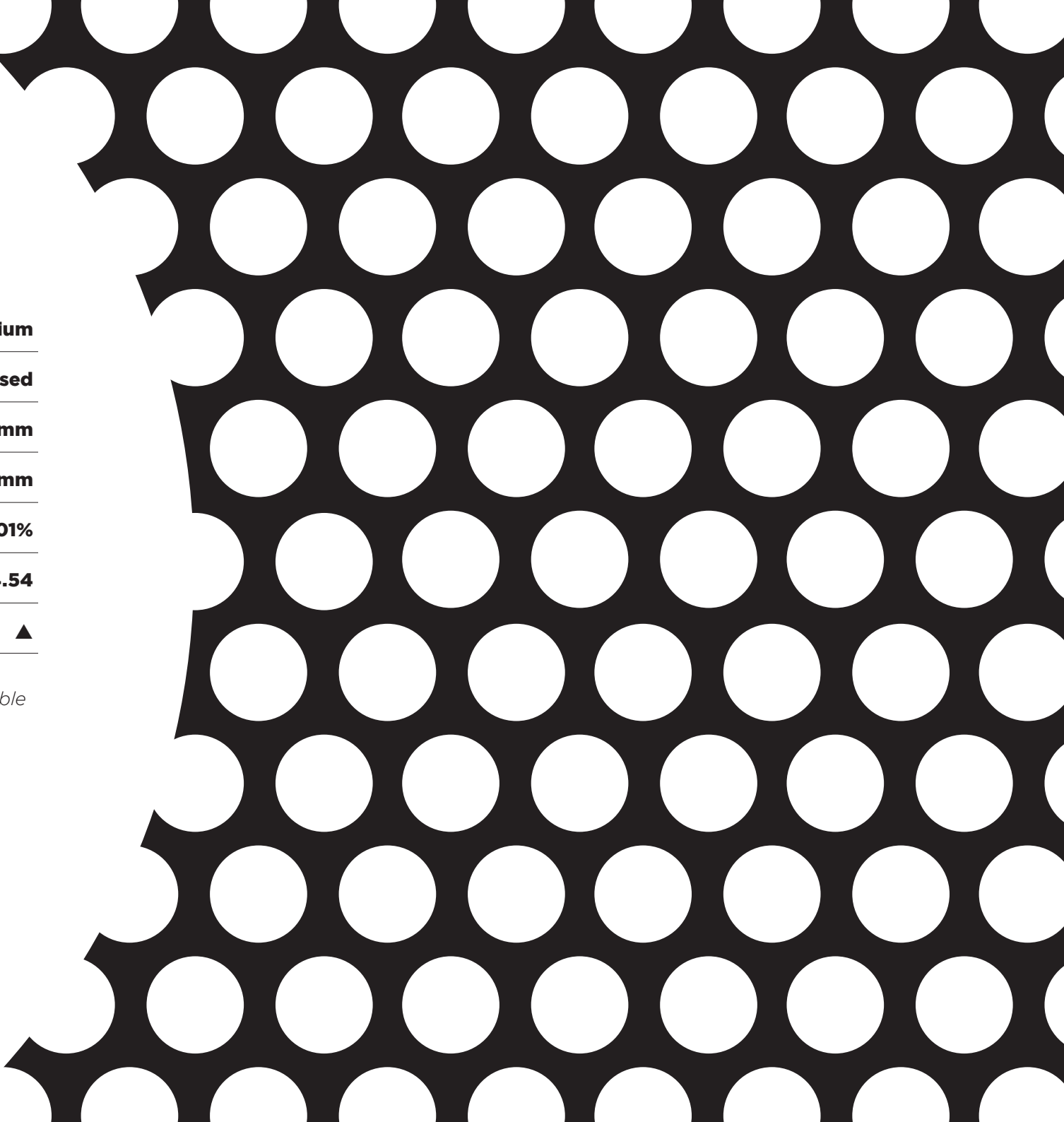

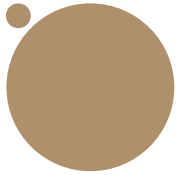

Light Wash

Specifications

Material	3mm 5005 grade Aluminium
Finishes available	Powdercoat or Anodised
Standard width*	1200mm
Standard length*	2400mm
Open Area	53.66%
Weight Kg/m ²	4.35
Wind noise rating†	●

* Larger custom widths and lengths available

† See page 4

Pattern shown at actual size

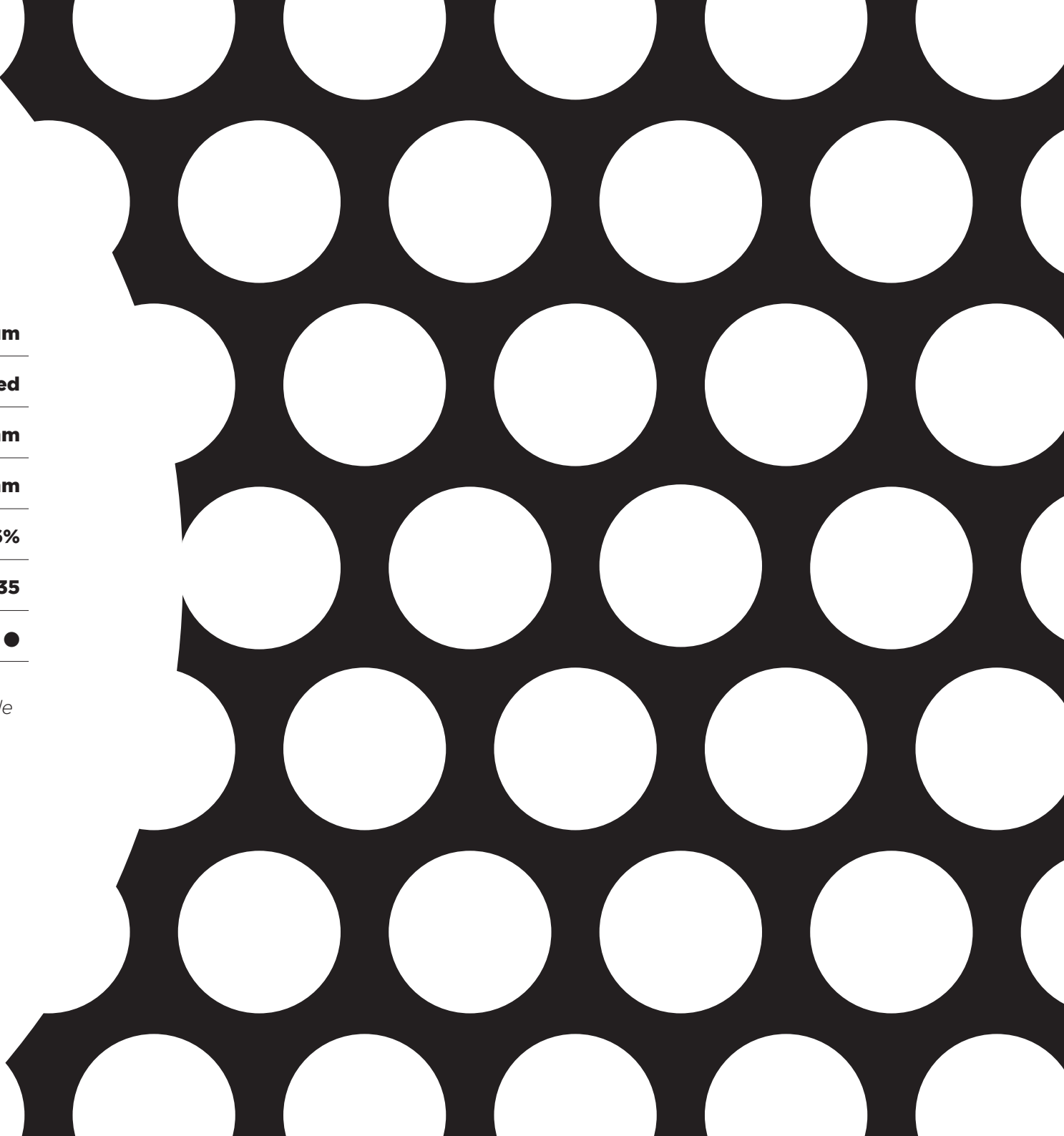

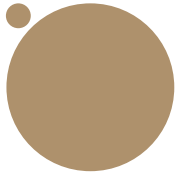

Light Shade

Specifications

Material	3mm 5005 grade Aluminium
Finishes available	Powdercoat or Anodised
Standard width*	1200mm
Standard length*	2400mm
Open Area	54.86%
Weight Kg/m ²	4.27
Wind noise rating†	●

* Larger custom widths and lengths available

† See page 4

Pattern shown at actual size



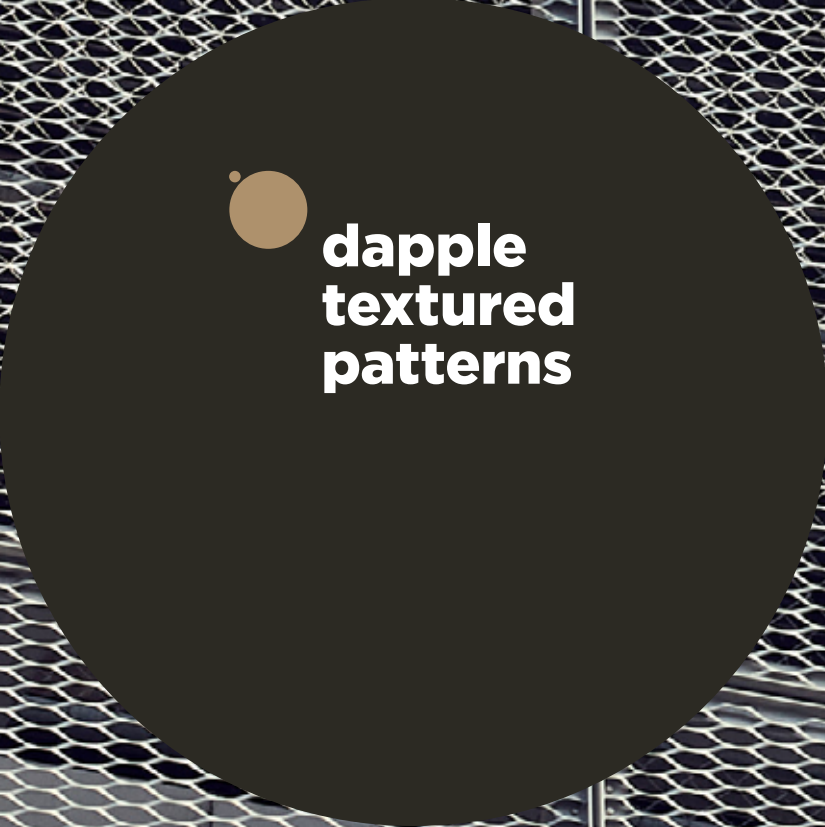

daple textured patterns

A distinctive woven, three-dimensional appearance for adding depth and texture.

Daple textured patterns are created when sheet metal is slit and formed in one motion. No material is removed.

Every textured pattern is designed, developed and wind tested by Insol, in New Zealand.

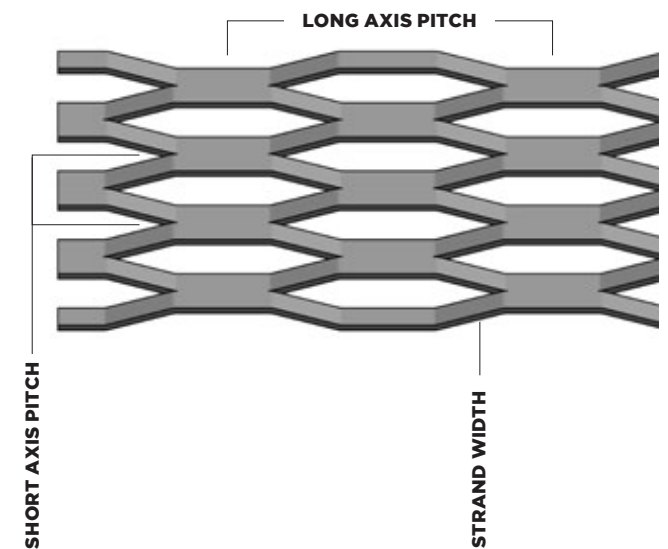



Flicker

Specifications

Material	3mm 5005 grade Aluminium
Finishes available	Powdercoat or Anodised
Standard width*	1200mm
Standard length*	3600mm
Open Area	48.52%
Weight Kg/m ²	3.17
Wind noise rating†	●
Short axis pitch	20.5
Long axis pitch	38
Strand width	4

** Larger custom widths and lengths available*

† See page 4

Pattern shown at actual size

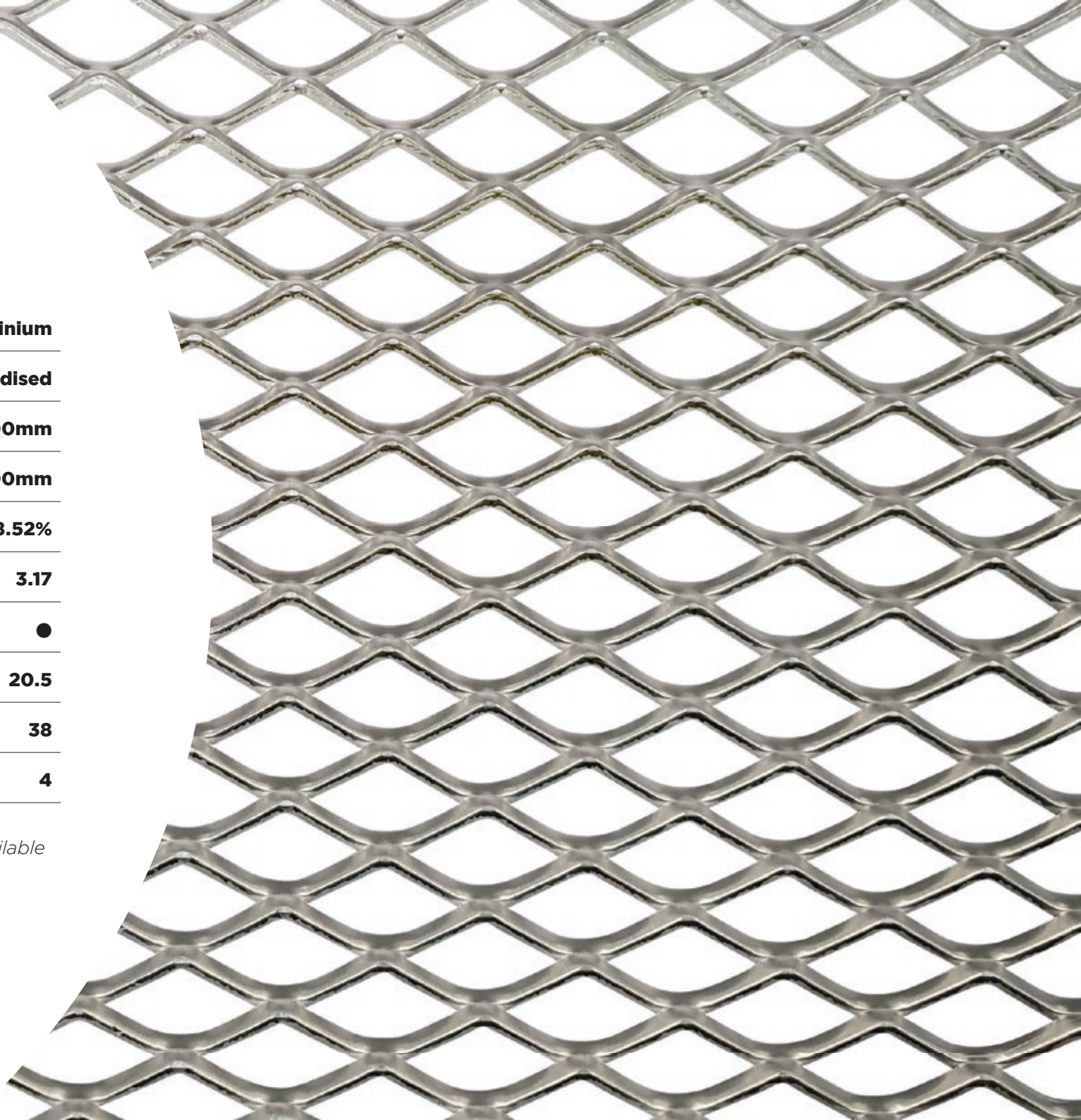



Twinkle

Specifications

Material	3mm 5005 grade Aluminium
Finishes available	Powdercoat or Anodised
Standard width*	1200mm
Standard length*	3600mm
Open Area	45.77%
Weight Kg/m ²	4.07
Wind noise rating†	●
Short axis pitch	20
Long axis pitch	52
Strand width	5

** Larger custom widths and lengths available*

† See page 4

Pattern shown at actual size

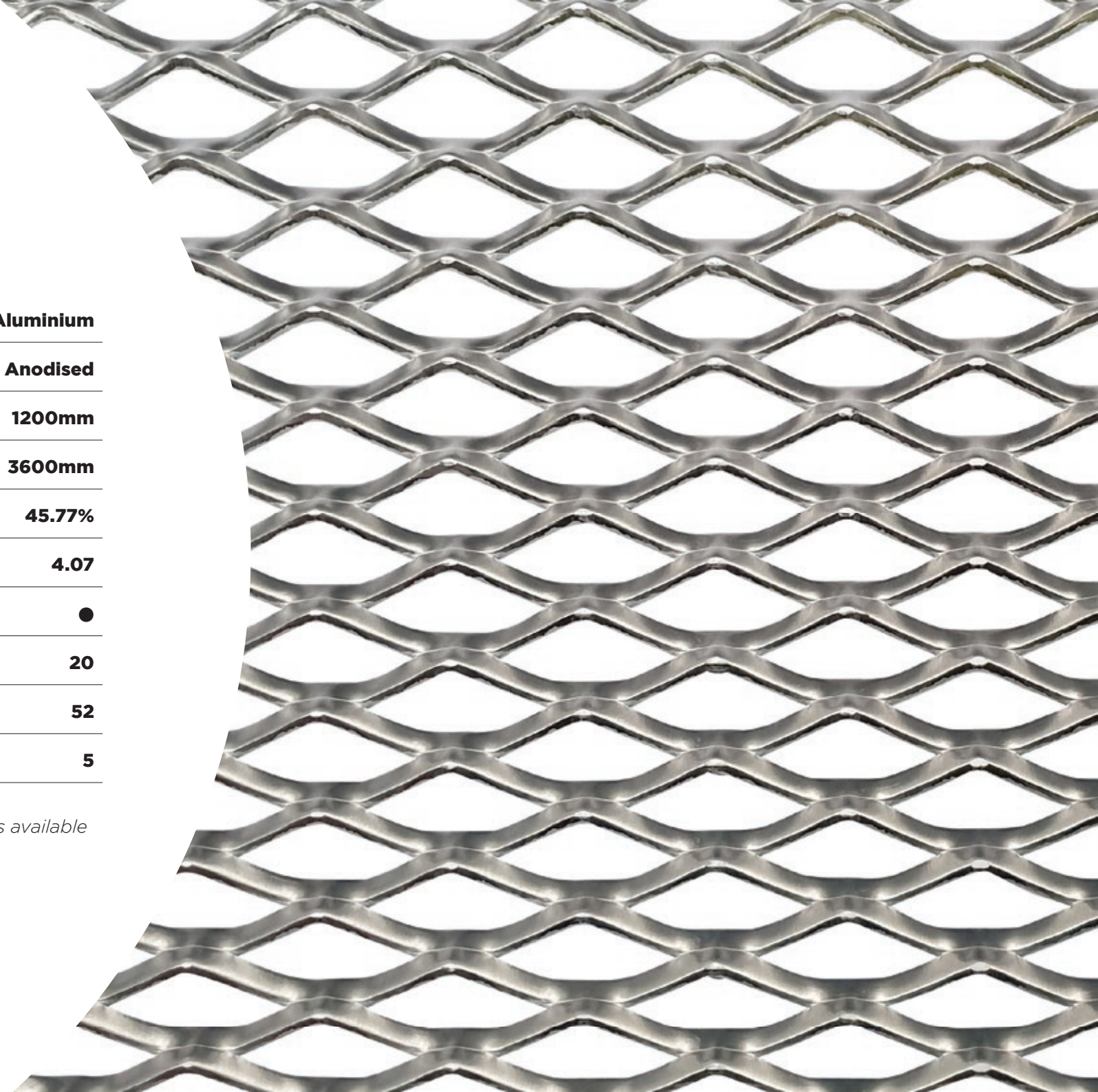

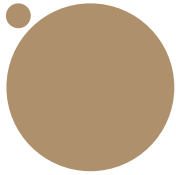

Sparkle

Specifications

Material	3mm 5005 grade Aluminium
Finishes available	Powdercoat or Anodised
Standard width*	1200mm
Standard length*	3600mm
Open Area	47.95%
Weight Kg/m ²	4.38
Wind noise rating†	●
Short axis pitch	26
Long axis pitch	75
Strand width	7

* Larger custom widths and lengths available

† See page 4

Pattern shown at actual size

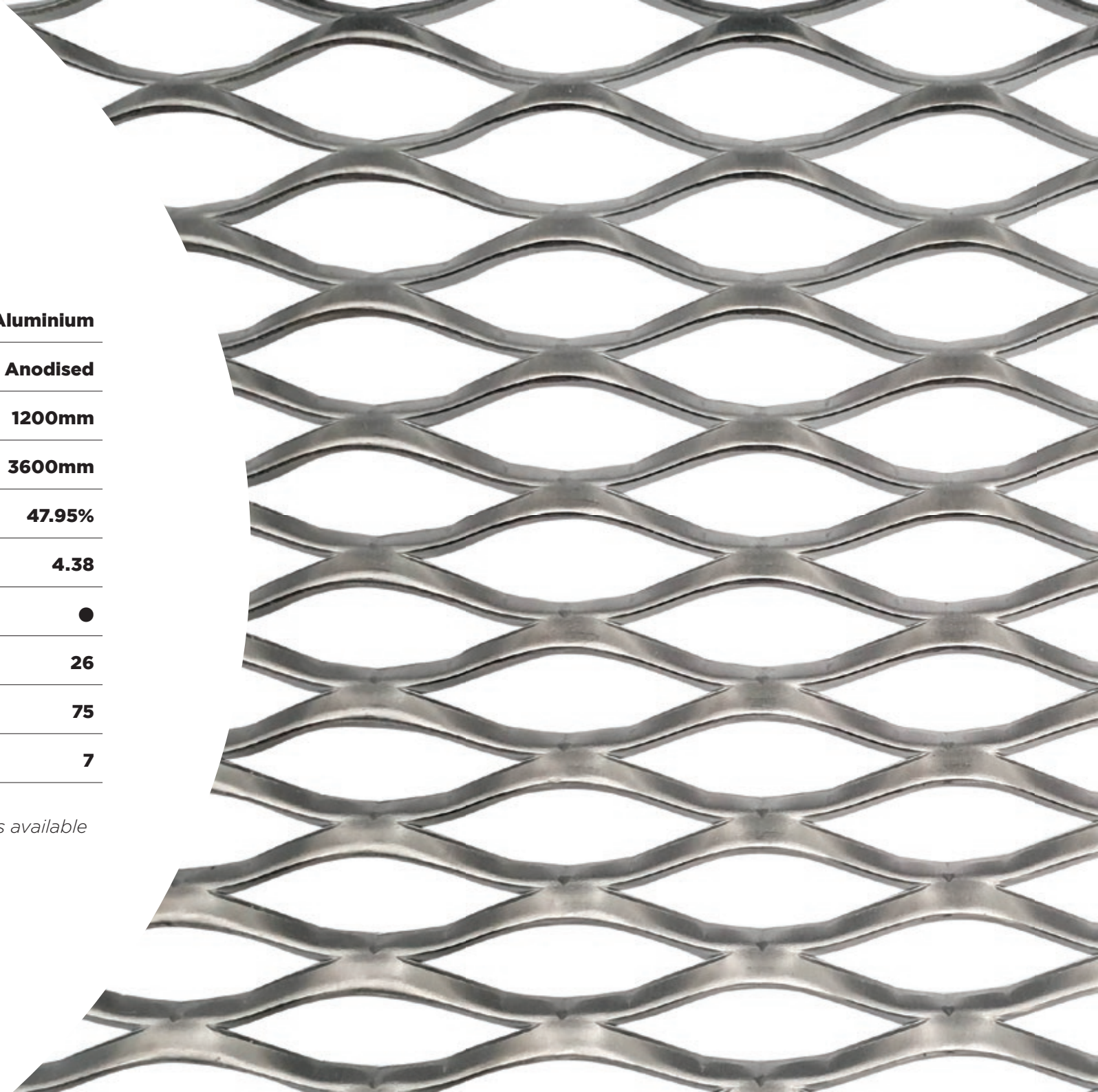

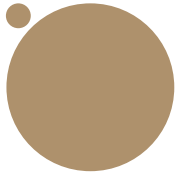

Gleam

Specifications

Material	3mm 5005 grade Aluminium
Finishes available	Powdercoat or Anodised
Standard width*	1200mm
Standard length*	3600mm
Open Area	32.75%
Weight Kg/m ²	5.71
Wind noise rating†	●
Short axis pitch	28.5
Long axis pitch	75
Strand width	10

* Larger custom widths and lengths available

† See page 4

Pattern shown at actual size

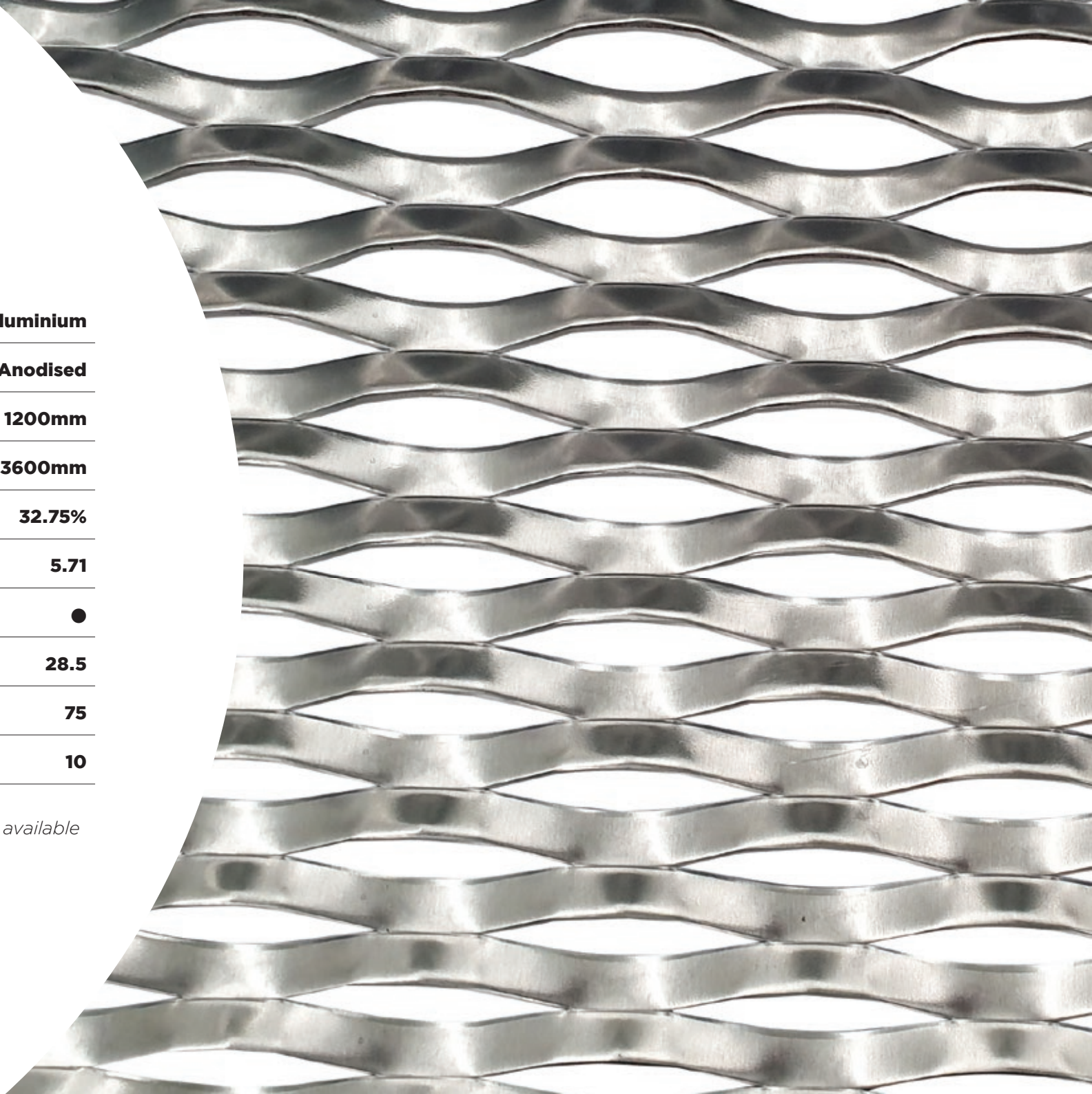

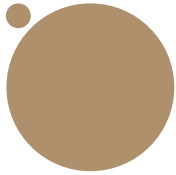

Shimmer

Specifications

Material	3mm 5005 grade Aluminium
Finishes available	Powdercoat or Anodised
Standard width*	1200mm
Standard length*	3600mm
Open Area	71.16%
Weight Kg/m ²	4.36
Wind noise rating†	●
Short axis pitch	41
Long axis pitch	136
Strand width	11

** Larger custom widths and lengths available*

† See page 4

Pattern shown at actual size

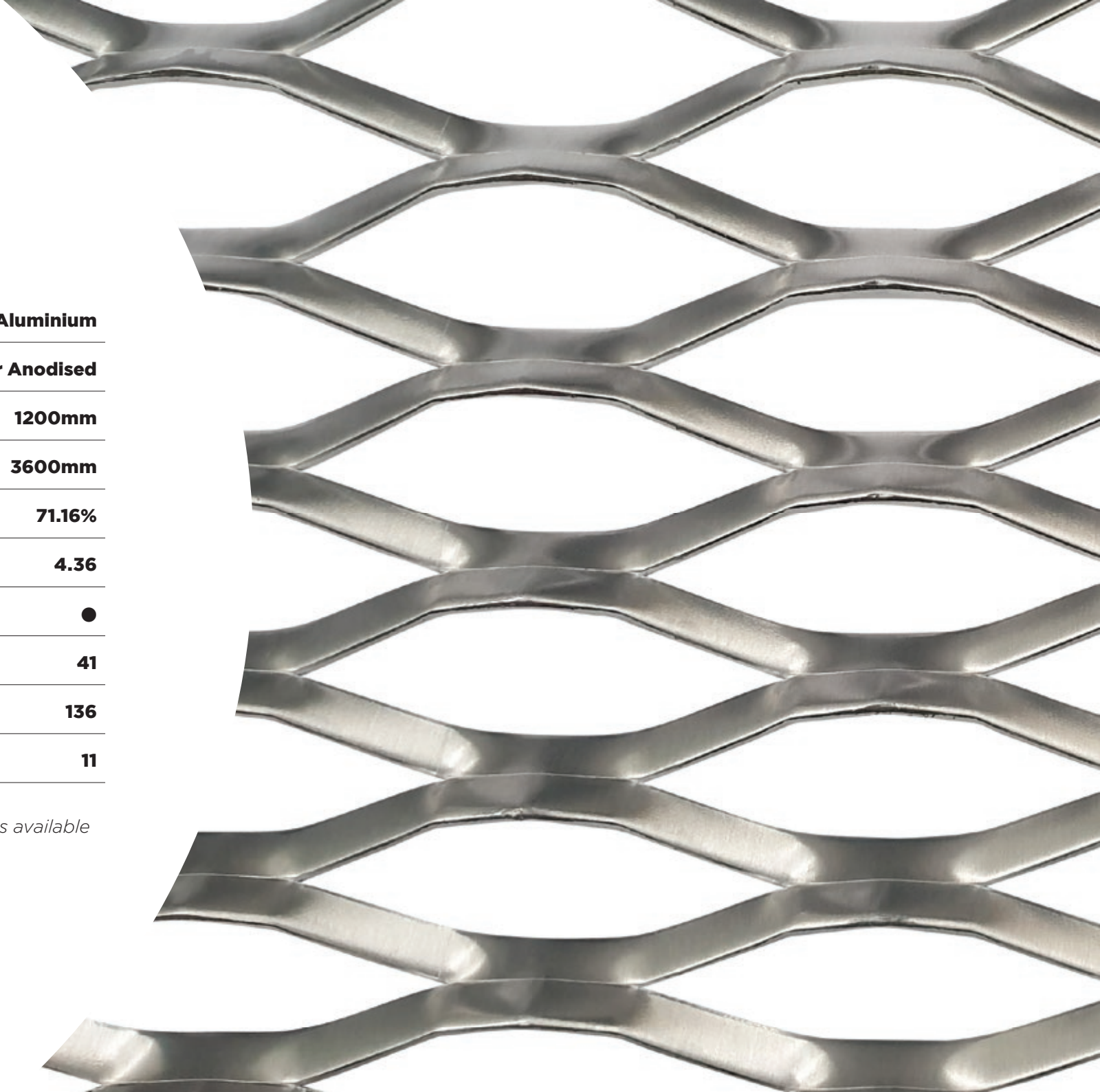

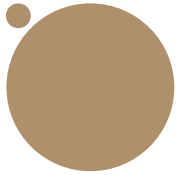

Beacon

Specifications

Material	3mm 5005 grade Aluminium
Finishes available	Powdercoat or Anodised
Standard width*	1200mm
Standard length*	3600mm
Open Area	75.12%
Weight Kg/m ²	3.52
Wind noise rating†	●
Short axis pitch	37
Long axis pitch	136
Strand width	8

** Larger custom widths and lengths available*

† See page 4

Pattern shown at actual size

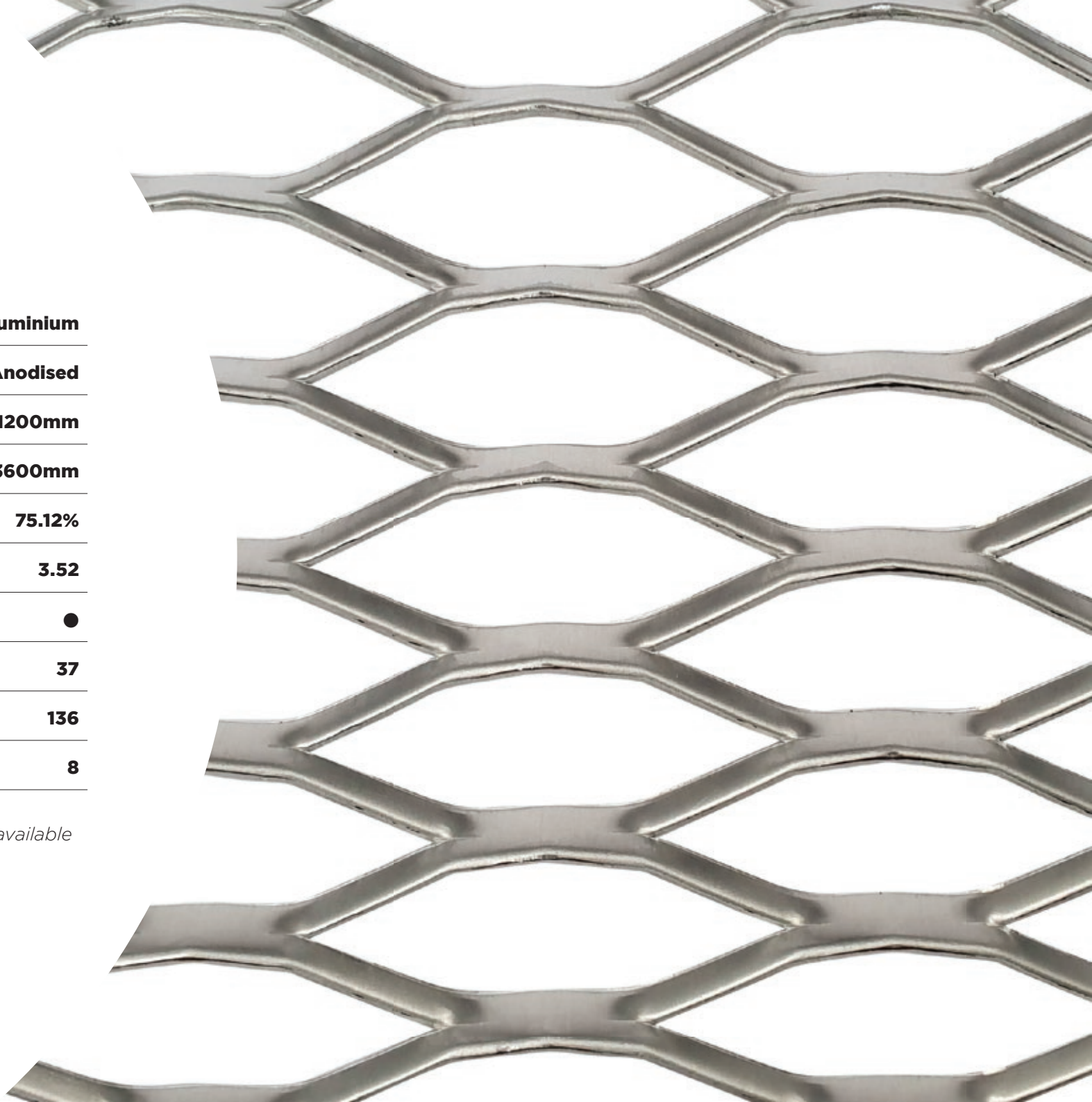



Holiday Inn Express, Queenstown

Architect McAuliffe Stevens

Construction Naylor Love

Details Customised dapple, consisting of both flat and textured panels act as a rainscreen whilst meeting architectural intent by covering the building in a glacier like appearance.

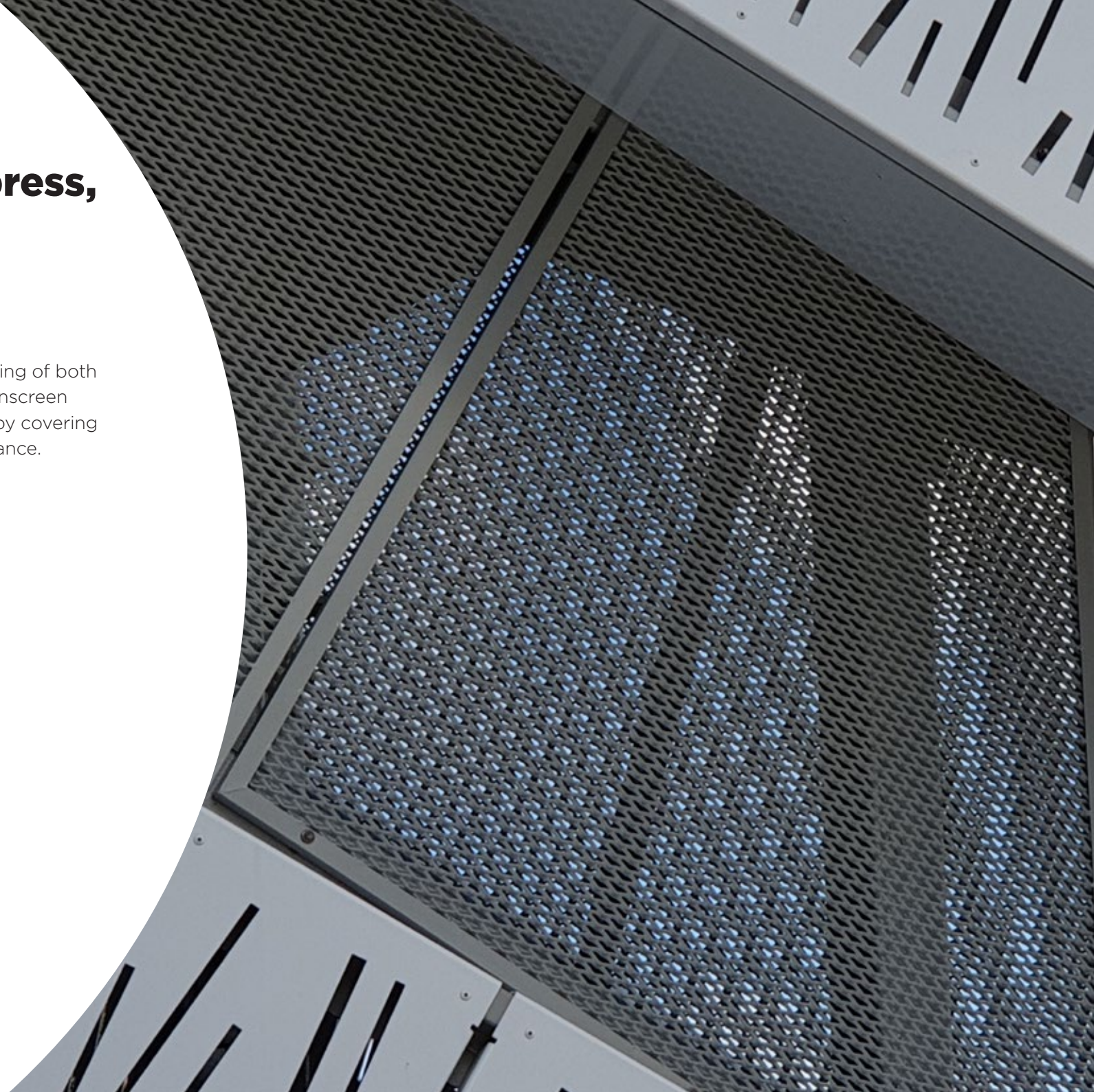



Customizing dapple

The only limitation with dapple is your imagination.

We can work with you on a customised perforated design that is completely bespoke.

For a highly differentiated aesthetic, picture perf can be developed to produce recognizable, photograph-like images through a unique arrangement of hole size and density.

And of course, we can wind test and rate the custom pattern.



Typical fixing details

Typical fixing details

A standard range of fixing details provides discreet and lasting fixing for most uses, with varying degrees of concealment available.

For specific design requirements and to meet architectural intent, bespoke solutions can be developed and engineered, adapting *dapple* to any surface and placement.

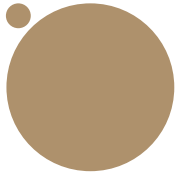

Face Fix

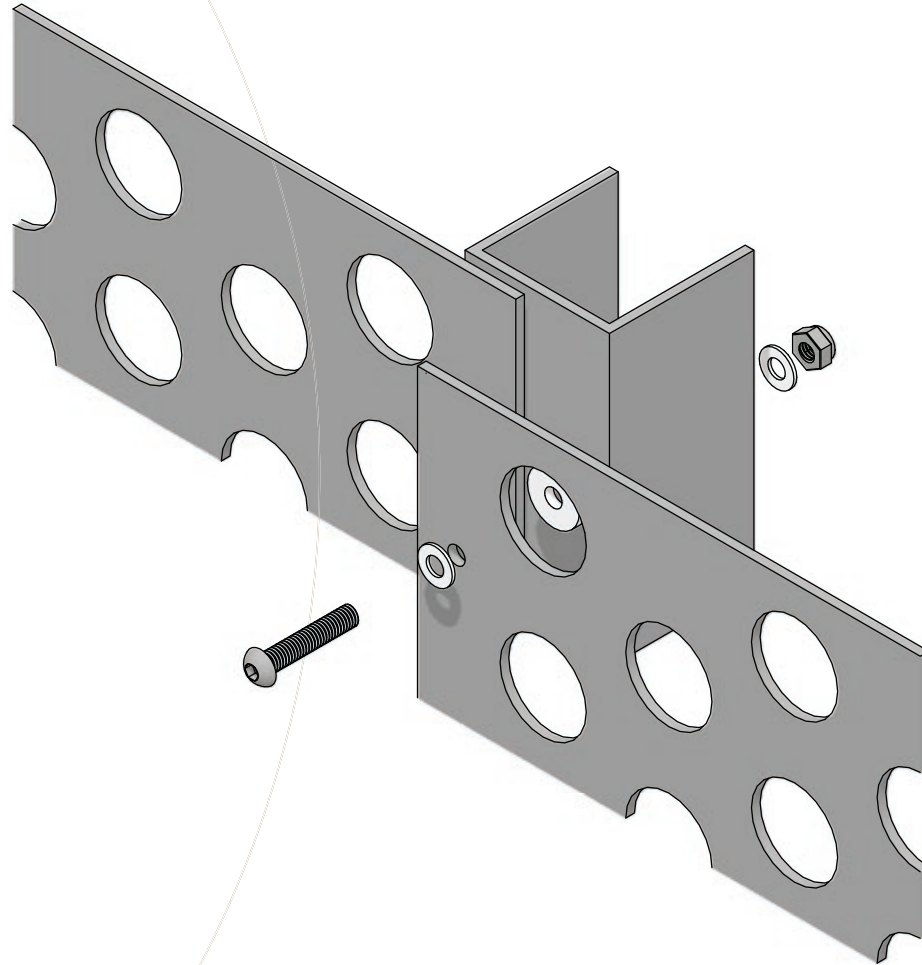

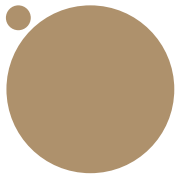

C Fold

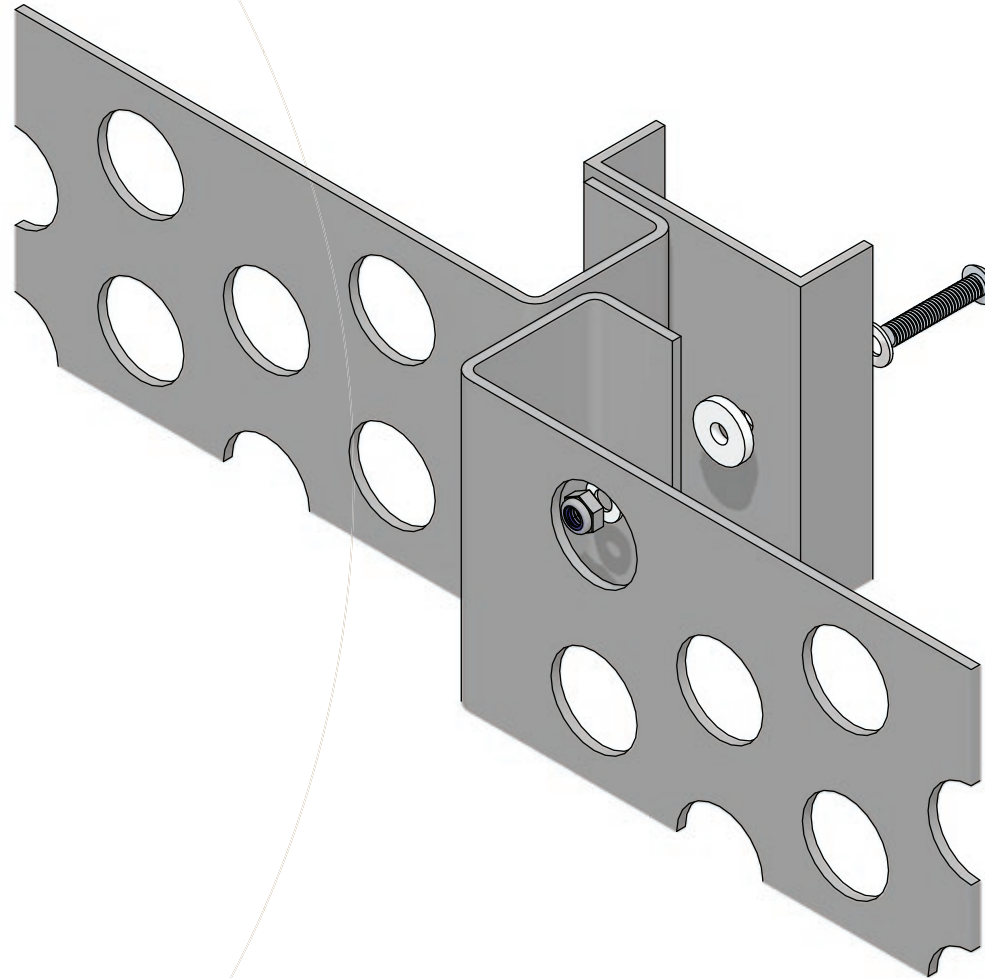

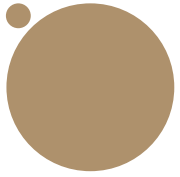

Hook and Rail

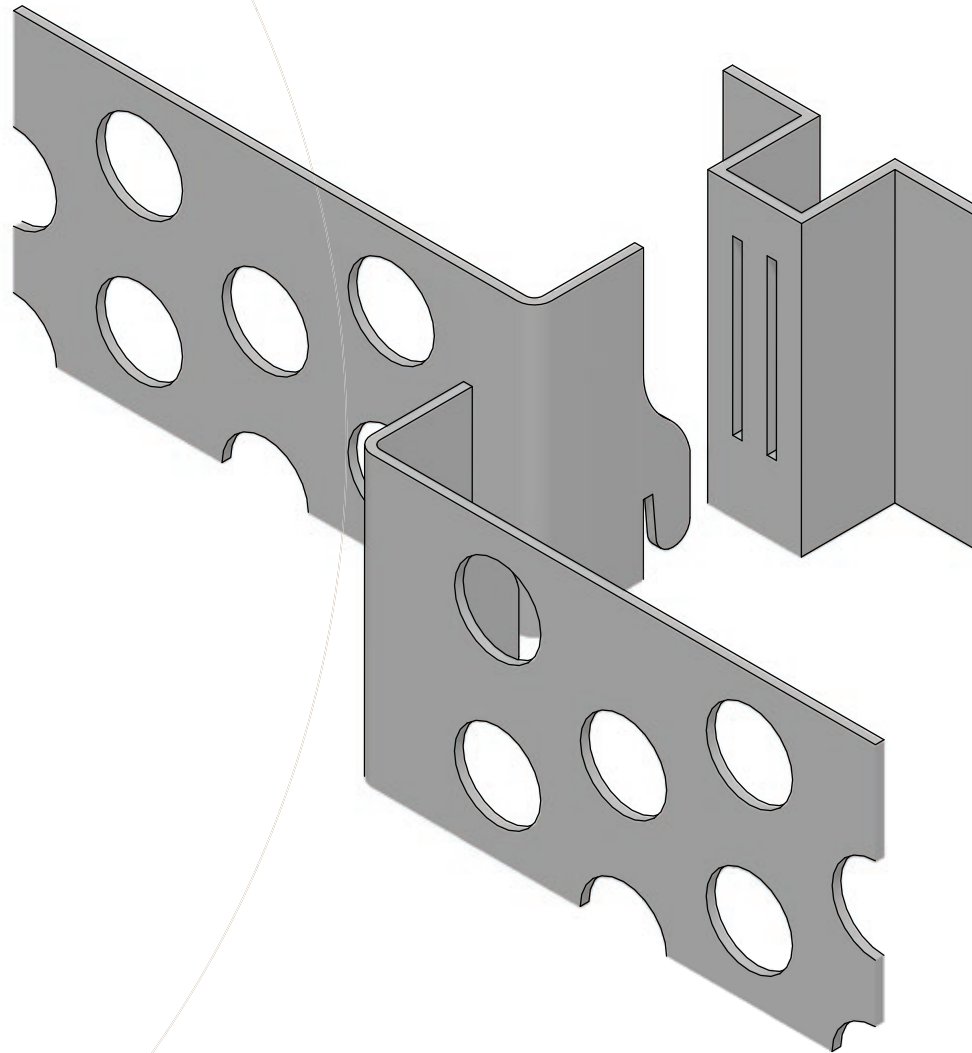

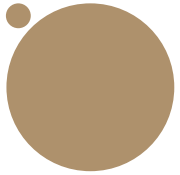

L Fold

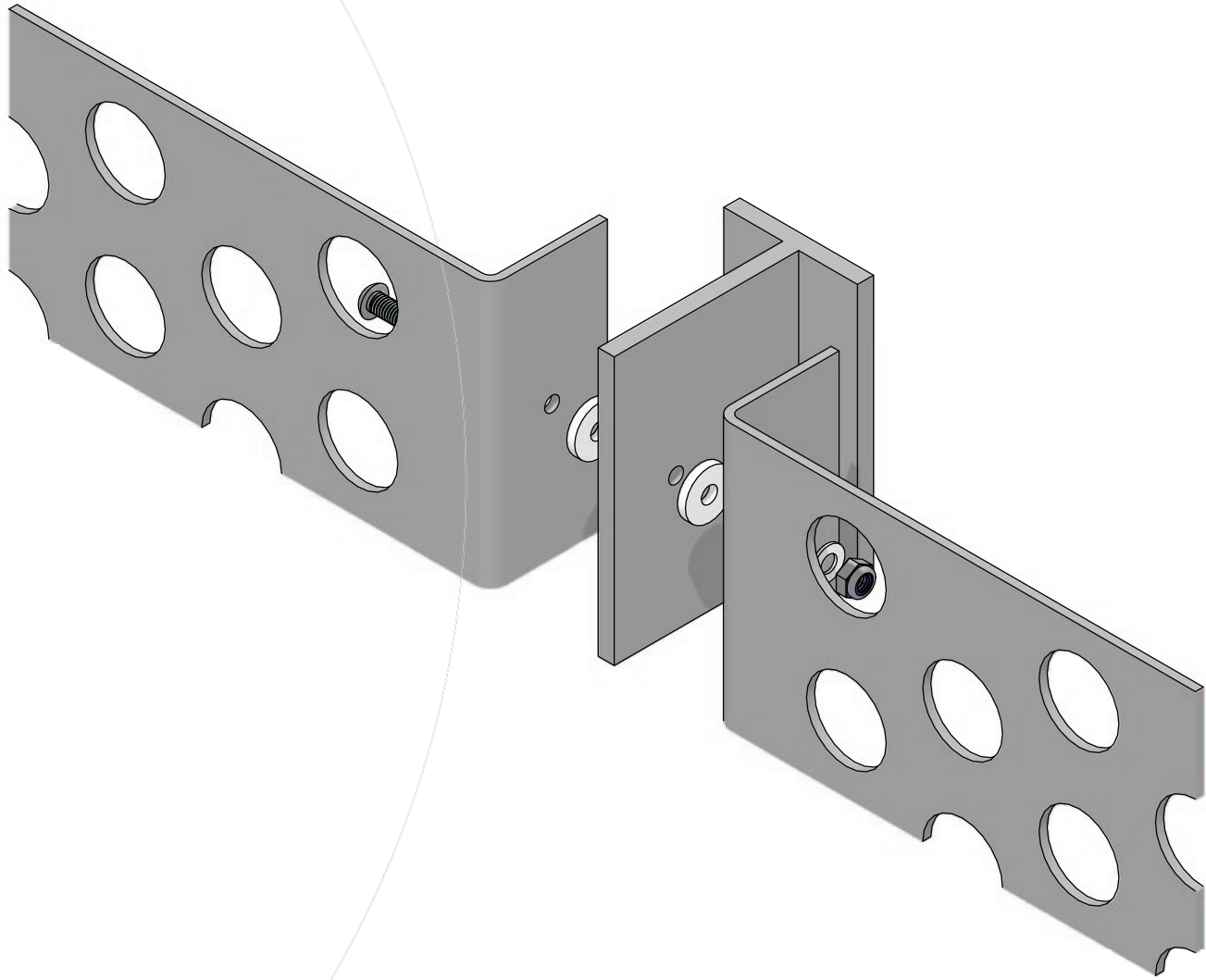

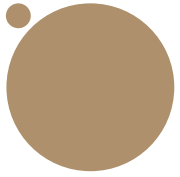

Riveted Channel Frame

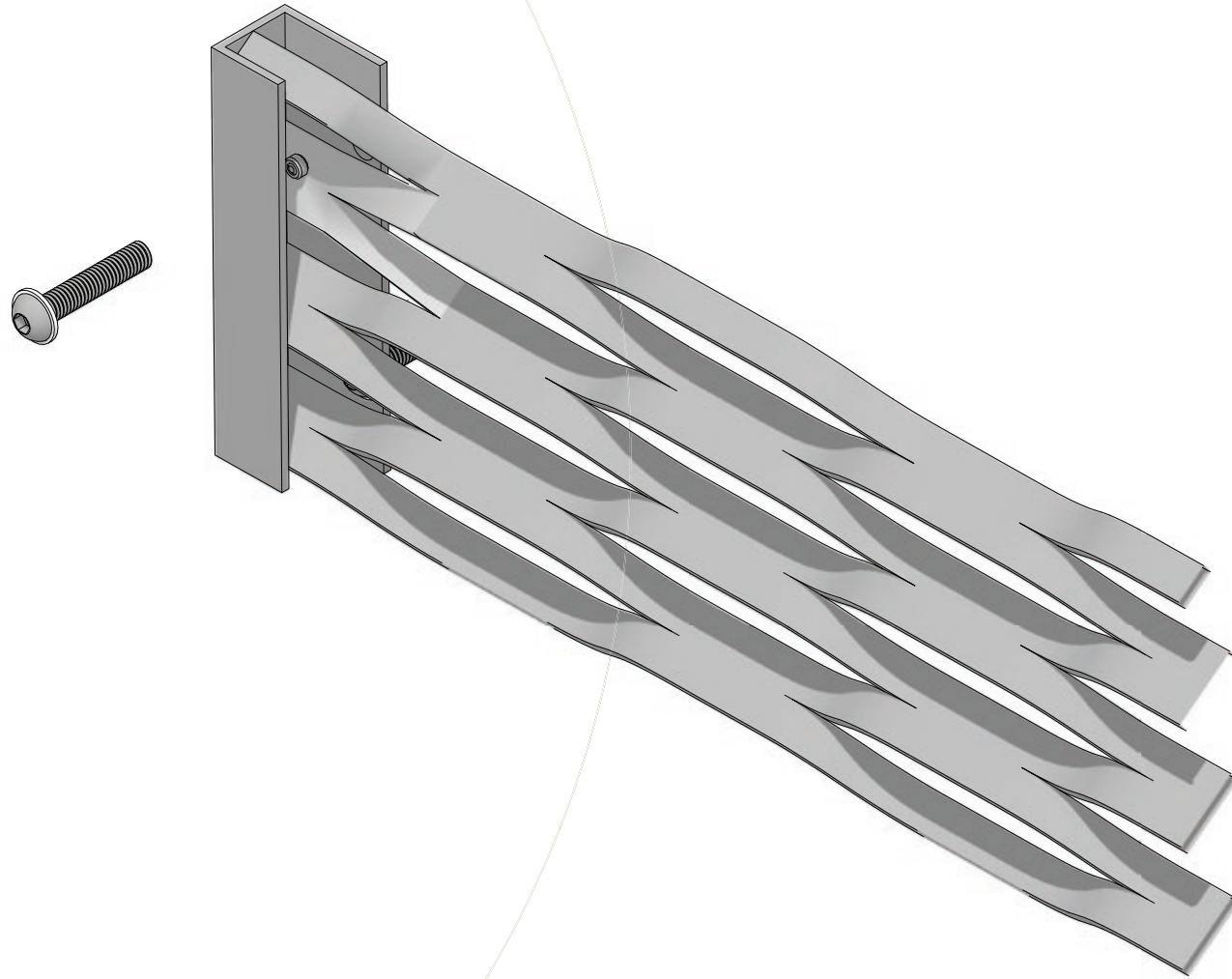

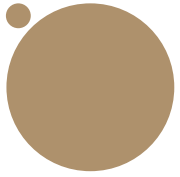

Welded Angle Frame

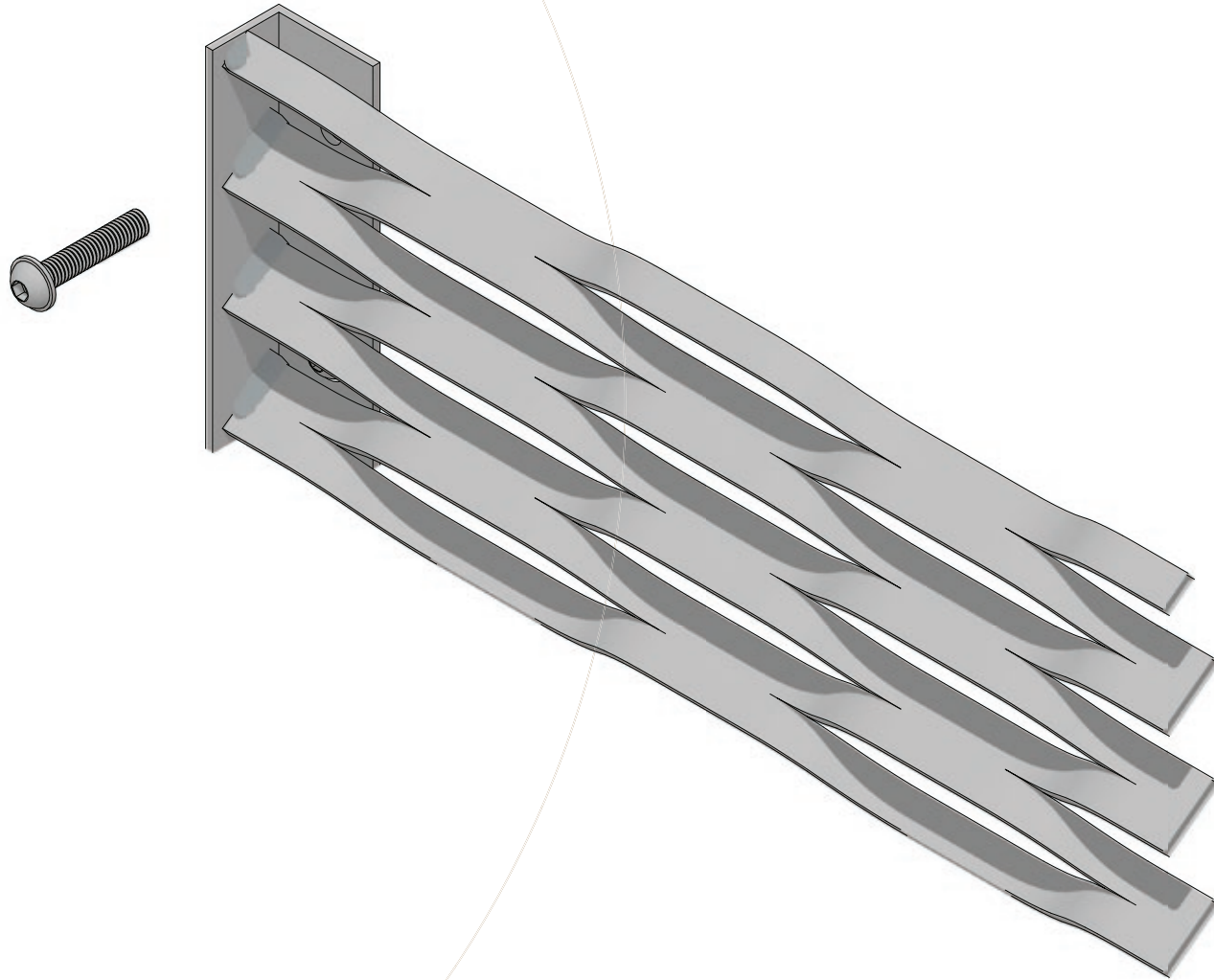

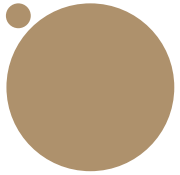

Clamp and Rail

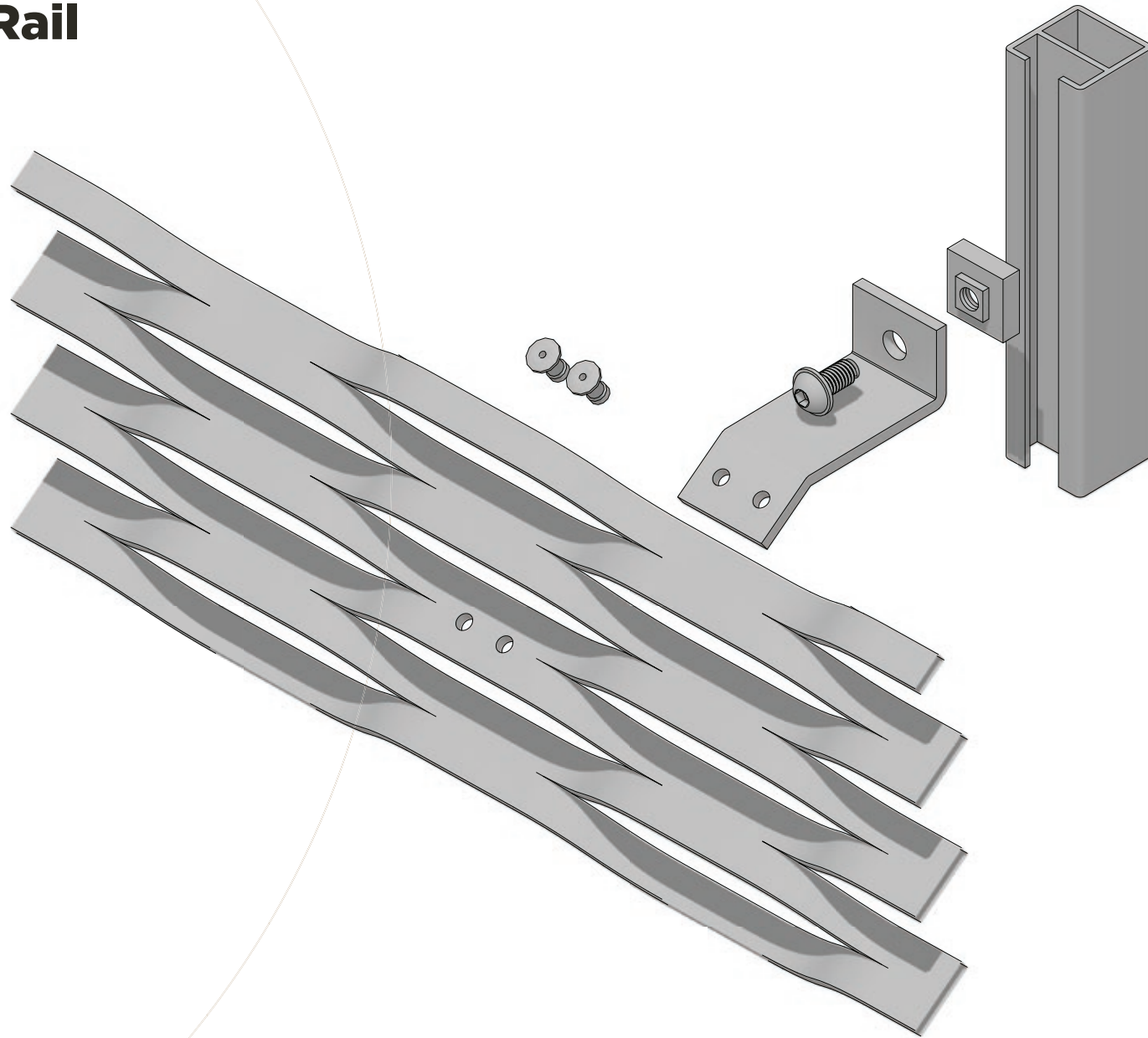



www.dapple.nz

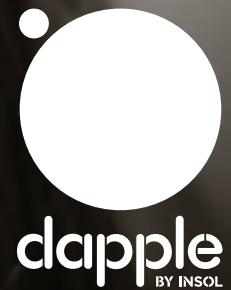

Invercargill 34 Onslow Street, PO Box 231, Invercargill. Ph: 03 216 3287 enquiries@dapple.nz

Auckland 7 Waokauri Place, Mangere, Auckland. Ph: 09 276 9735 enquiries@dapple.nz

