



*Clearing The Airway Is Our #1 Priority*

## Operating Instructions & Maintenance Manual



**SSCOR** VX-2<sup>®</sup>

Model 2310 Series

**SSCOR** INC.  
11064 Randall Street  
Sun Valley, CA 91352 USA

www.sscor.com  
shop.sscor.com  
Email: marketing@sscor.com  
techsupport@sscor.com



Tel 1+818-504-4054



**Intertek**



*Clearing The Airway Is Our #1 Priority*

## Caution Notice

---

1. SSCOR suction units are not designed or intended for use in extended procedures that require prolonged high vacuum/low airflow applications, as is the case in wound drainage or endoscopic use or in any other procedure that produces high vacuum levels within an occluded system for an extended period of time. Turn the suction unit off when it is not in use.
2. Federal law restricts this device to sale, distribution, and use by, or on the order of a physician, emergency medical technician, or other medical practitioner. For use by medical personnel trained in suctioning techniques and in the use of medical suction equipment.
3. Operator should be thoroughly familiar with these operating instructions before this device is used.
4. Do not use in the presence of flammable agents or anesthetics.
5. Before testing for vacuum over -300mmHg look for an expiration date on the canister (where applicable) and change the canister if the canister has passed the expiration date to minimize the possibility of implosion, which can occur when a canister is aged or damaged.
6. External equipment intended for connection to signal input, signal output or other connectors, shall comply with relevant IEC standard (e.g. IEC 60950 for IT equipment and the IEC 60601 series for medical electrical equipment). In addition, all such combinations–systems – shall comply with the standard IEC 60601-1-1, safety requirements for medical electrical systems. Equipment not complying with IEC 60601 shall be kept outside the patient environment, as defined in the standard. Any person who connects external equipment to signal input, signal output or other connectors has formed a system and is therefore responsible for the system to comply with the requirements of IEC 60601-1-1. If in doubt, contact qualified technician or your local representative.
7. A blinking LED on the control panel indicates low battery capacity. This means the battery has been subjected to irreparable damage. REPLACE THE BATTERY! Replacement battery may be purchased at [shop.sscor.com](http://shop.sscor.com).
8. This device is not intended for suctioning neonates (newborn child), for Pediatric and Adult use only.
9. Dispose of device according to local / regional / national requirements for the disposal of electronic waste at the end of the expected service life.
10. Dispose of single use accessories according to local / regional / national requirements for the disposal of hazardous waste.
11. When running the device from an external AC power converter do not position the device in a way that makes it difficult to unplug the barrel connector from the device.
12. SSCOR aspirators are intended for use in various electromagnetic environments typified by hospital and EMS situations and public establishments that use standard mains power. It is recommended that the user test SSCOR aspirators in conjunction with other devices that may be in operation at the time of use. SSCOR aspirators have very low RF emissions and are not likely to cause interference in nearby electronic equipment. SSCOR also recommends the other devices in the environment at the time of use also meet IEC 60601EMC/RF requirements.

SSCOR VX-2® Model 2310 Series - New Generation Suction for Pre-Hospital Care ©2015 HI-D and Big Stick are registered trademarks of SSCOR, Inc.



Clearing The Airway Is Our #1 Priority

## Table of Contents

---

Caution-Notice	Page 2
General Description	Page 3
Warranty	Page 3
Description of Symbols	Page 4
Getting Acquainted	Page 5
Battery Test & Trouble Shooting	Page 6
General Specification	Page 7
Internal Access for Electrical and Pneumatics	Page 8
Maintenance, Sanitation and Disinfection Instructions	Page 9
Retention Bracket Mounting Instructions	Page 10

## General Description

---

SSCOR suction units are designed for hospital crash carts, patient transport and emergency medical service. Battery condition is automatically monitored and visualized by indicator lights on the control panel. The battery should be charged to a dependable working charge in 6 to 8 hours when connected to the charging source. Suction power can be regulated when full power may be considered harmful to the patient. SSCOR suction units are designed to provide instant, effective suctioning, independent of external sources of power and can be pre-set to be activated immediately upon reaching the distressed patient. All controls are clearly labeled and easily accessible.

The SSCOR VX-2 is a portable, 12V DC battery operated suction device for resuscitation emergencies in prehospital care. The battery is recharged by an internal, DC dual mode battery charger which is activated by the AC-DC converter or direct connection to the vehicle electrical system. The charger monitors the battery, charges the battery only when necessary, shuts down the unit if the battery is low and signals battery condition. A fully charged battery at full capacity will power the unit for 45 minutes ( $\pm 10\%$ ).

## Warranty

---











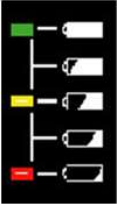

SSCOR warrants that each new product is free from defects in material and workmanship under normal use and service for a period of one year from date of purchase. This warranty gives you specific legal rights and you may also have other rights that vary from jurisdiction to jurisdiction. For countries where minimum warranty terms are determined by statute, the warranty term is the longer of the statutory period or the term listed above. Batteries, disposable items including collection canisters, patient tubing and catheters are excluded from this warranty.

See the SSCOR Warranty for terms and conditions, available on [www.sscor.com](http://www.sscor.com)

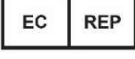
### **SSCOR VX-2® with Charging / Retention Bracket Battery Replacement Policy**

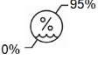
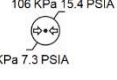
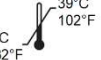
If the SSCOR VX-2 is purchased with the Charging / Retention Bracket, SSCOR will replace the battery if the battery fails to operate the pump to specifications for a period of three years from the date of purchase. Verify the condition of the battery per the battery test on Page 6 in this Operations Manual.

## Description of Symbols

SYMBOL	LOCATION	MEANING
	Control Panel	Battery Level of Charge Green LED = Full Green / Yellow LED = High Yellow LED = Half Yellow / Red = Low Red LED = Battery Depleted Put device back on charge!
	Control Panel	Push On / Push Off
	Serialized Label	Attention—Consult Accompanying Documents
	Serialized Label	Separate collection for electronic equipment
	Serialized Label	Type BF Equipment
	Shipping Carton	Manufacturer
	Shipping Carton	Date of Manufacture
	Shipping Carton	Authorized Representative in the European Community
	Shipping Carton	Transport Storage Range
	Shipping Carton	Humidity
	Shipping Carton	Atmospheric Pressure
	Serialized Label	Operating Temperature Range
<b>IP34</b>	Serialized Label	The degree of protection provided by the chassis according to IP34
	Front of Device	Suction
	Control Panel	Pump is On
	Control Panel	Power Source Connected

## Getting Acquainted

---

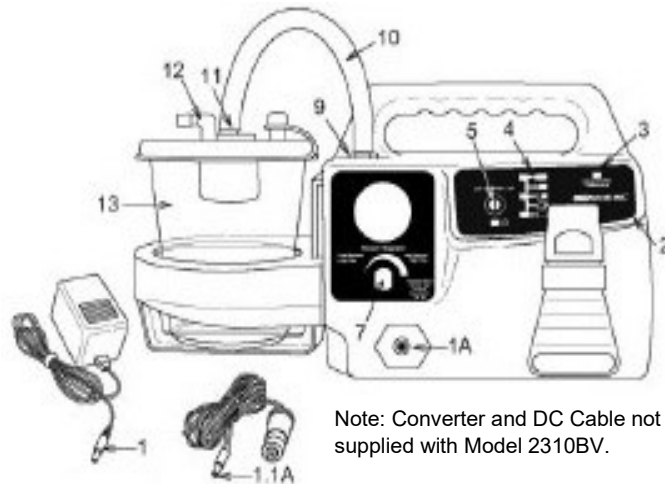

### Running the unit from DC power

1. Disconnect the power cord (1) and press the ON/OFF switch (5) on the control panel to start the vacuum pump.
2. Check battery condition indicators (4)

### Adjusting the vacuum level

- Occlude the patient tube and turn the vacuum regulator (7) clockwise to the stop.
- Observe gauge (located above the vacuum regulator). The vacuum reading should rise to -300mmHg from zero in 3 seconds. It should max out at approximately  $\geq -525\text{mmHg}$ . Lower levels of negative pressure will be observed at altitude.

### DC Battery Charging from AC Power Using AC-DC Converter

The 80521-100 AC Converter will not run the pump. If battery charging from AC power is required, connect the SSCOR AC-DC converter (1) to an AC outlet. The converter connects to the unit through the receptacle (1A) on the front panel. Do not attempt to run the pump with the AC converter attached to the pump.

**Remove the AC converter connection from the pump prior to any suction procedure.**

### DC Battery Charging from Vehicle

Connect the DC power cord to the cigarette lighter receptacle in the vehicle or hard wire the DC power cord to the DC electrical system of the vehicle on a properly fused line in front of the master switch. Connect the electrical line cord to the suction unit by securely attaching the charging plug (1.1A) into the receptacle (1A). This charging method is designed to keep the battery charging at all times. If the suction unit is operated while it is hooked up to the vehicle it will utilize the vehicle power and save its own battery for emergency use. All SSCOR suction units have a diode to prevent drawdown from the pump to the vehicle electrical system and a fuse to protect the pump from vehicle electrical surges. If your suction unit is wired to the vehicle battery via an automatic load switch power supply, be sure to use a filter in order to eliminate any voltage spikes.

### Battery Charging Verification

Once the unit is connected to the charging source, check the control panel (2). The "power source connected" LED (3), when lit, shows a good connection and indicates the battery is charging.

### Charging the Battery Using the 8310 Charging / Retention Bracket Model 2310BV Only):

Hard wire the Model 8310 Charging / Retention Bracket to the hot DC circuit (in front of the master switch). Make certain the circuit is properly fused according to appropriate vehicle standards. The vehicle electrical system will furnish power to both run the pump and charge the battery. See page 10 for additional information.

## Battery Test

Run the following test whenever poor battery quality is suspected to ensure proper performance of the device.

1. Check that the power source connected LED on the control panel (3) and the green battery condition LED are lit.
2. Remove the power cord and run the unit from its internal DC battery.
3. Check for vacuum by occluding the patient tube and set the vacuum regulator (7) to the maximum vacuum setting.
4. Observe the regulator gauge (8). The vacuum reading should rise to -300mmHg from zero in less than 3 seconds. It should max out at  $\geq -525\text{mmHg}$ . Un-occlude the patient tubing.
5. Allow the unit to run for 15 minutes on DC power. If the unit stops or slows during the 15 minutes, or if the battery condition indicators (4) begin to blink, it is possible the battery capacity has been depleted. It is time to replace the battery.
6. If the unit is still running at full power after 15 minutes, adjust the regulator to the desired setting, turn the device off and put it back on charge.

**SSCOR recommends replacement of the battery after 3 years.**  
**Replacement battery may be purchased at [shop.sscor.com](http://shop.sscor.com).**

## Environmental Conditions

Operating Temperature Range:	0 °C (+32 °F) – +39 °C (+102 °F)
Operating Relative Humidity:	0 - 93% (non condensing)
Operating Atmospheric Pressure:	8.9 Psi (62 kPA) – 15.4 Psi (106 kPA)
Operating Altitude:	<2000m
Storage & Transport Temperature:	-40 °C (-40 °F) – +70 °C (+158 °F)
Storage & Transport Relative Humidity:	0 - 95% (non condensing)
Storage & Transport Atmospheric Pressure:	7.3 Psi (50 kPA) – 15.4 Psi (106 kPA)
Transient Operating Temperature Range:	-20 °C (-4 °F) – +50 °C (+122 °F)
Transient Humidity Range:	15% - 93% (non condensing)
Time to warm from minimum storage temperature to operating temperature: 30 minutes	
Time to cool from maximum storage temperature to operating temperature: 30 minutes	

## Troubleshooting



**WARNING: DO NOT ATTEMPT TO SERVICE THIS EQUIPMENT IF YOU ARE NOT A QUALIFIED MEDICAL REPAIR TECHNICIAN**

PROBLEM	POSSIBLE CAUSE	CORRECTIVE ACTION
Power Source Connected LED not lit	Molex connections disconnected Power cord disconnected	Reconnect Molex Reconnect cord
Does not function when switch is turned on	Battery discharged Molex connections disconnected	Reconnect to charging source Open unit and re-connect Molex connections
Blinking LED	Low battery capacity	Replace battery
No suction when pump is running	Vacuum line (10) loose Canister (13) defective Canister lid (13) loose Catheter thumb vent is open Debris has collected in the pump	Inspect pneumatic connections Replace canister Re-secure canister lid Occlude thumb vent on suction tip Replace pump



Clearing The Airway Is Our #1 Priority

## General Specifications

CHARACTERISTICS	SPECIFICATIONS
Size	17"L x 9"H x 5.25"W (43.18cm L x 22.86cm H x 13.33cm W)
Weight	10.15lbs (device only) 4.6 kgs (device only)
Vacuum Pump	12V DC. Clinical Airflow $\geq$ 30LPM Exceeds 525mmHg
Variable Regulator (7)	Controls negative pressure
Regulator Gauge (8)	Calibrated in mmHg. Color-coded
Power Source: Battery (DC Power)	Rechargeable Sealed Lead Acid. SSCOR part # 80635
Switch (5)	Off/Standby/On membrane switch
Collection Canister (13)	1200cc/ml SSCOR part #48041
Patient tubing	Vinyl tubing 9/32"ID x 72"L (7.1mm ID x 182.88 cm L) SSCOR part #43200
Suction Tip	HI-D® "Big Stick®" SSCOR part #44241C



For replacement parts and accessories, please visit [shop.sscor.com](http://shop.sscor.com)

## Internal Access



**WARNING:** Do not attempt to service this equipment if you are not a qualified medical repair technician. Take appropriate ESD abatement measures when handling all internal components.

To open or close the unit, first remove the canister holder:  
Remove the set screws on the canister bracket.  
Lift the canister holder up and out of the main chassis.

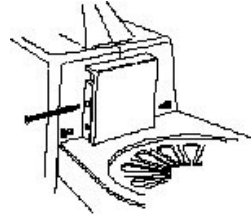

The clamshell design enables access to internal components. All 6-32 Phillips head fastening screws are located in back of the unit.

### REMOVE MAIN CHASSIS SCREWS

- (A) 1 screw under the canister holder
- (B) 2 screws in the back of the handle
- (B) 3 screws in the back of the main chassis.
- (C) It should not be necessary to open the exhaust door unless fluids have entered the system

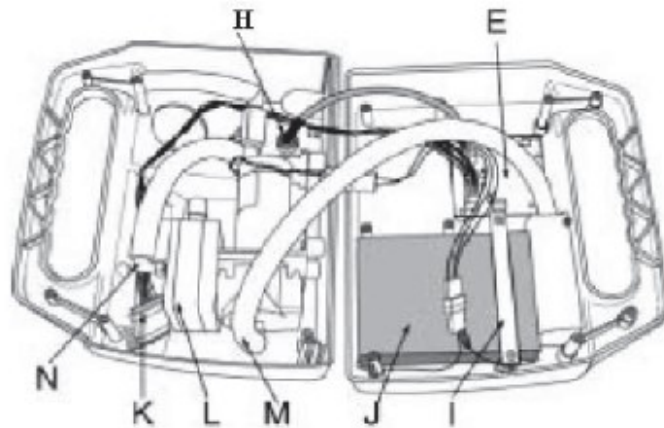
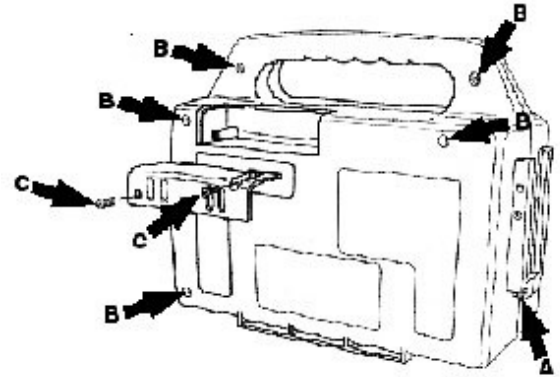

(D) PC Board-Electrical Circuits (Internal Dual Mode Battery Charger). Do not attempt to service the PC Board. Return to SSCOR or authorized service center for service.

(E) N/A

(F) N/A

(G) DC receptacle

(H) Battery Bracket

(I) Battery, 12V, Sealed Lead Acid

(J) Wiring connection to the control panel

(K) Vacuum pump. Return to SSCOR or authorized service center for service. Do not attempt to service the vacuum pump.

(L) Exhaust barb

(M) Vacuum barb





Clearing The Airway Is Our #1 Priority

## Maintenance

### Preventive Care

Observe the following maintenance routine to ensure readiness at any time:

1. When the SSCOR aspirator is not in use, keep batteries on continuous charge.
2. Test the SSCOR aspirator at regular intervals; See page 6.
3. Make sure the SSCOR aspirator is always clean and ready for use.
4. If the procedure produced an excessive quantity of fluids, check the vacuum line (7) for evidence of moisture. If the vacuum line between the pump and canister is moist, it is possible that fluids have reached the vacuum pump. See Disinfection Instructions below.

For technical assistance, call (800) 434-5211 or international +1 818-504-4054. For replacement parts and accessories, please visit [shop.sscor.com](http://shop.sscor.com).

Note: No part requires lubrication and lubricants should not be used.

### Sanitation

As soon as possible after use, the single use disposable canister, patient tubing and catheter should be discarded according to local / regional / national requirements for the disposal of hazardous waste materials. Clean using a mild detergent and if necessary, disinfect with a mild disinfectant such as 10 to 1 bleach and rinse using clear water to remove any residue.

If the exhaust filter is soiled, remove the two screws holding the filter door in place (see page 8), remove the soiled filter and replace with new filter (SSCOR part number 90160).

Do not reuse any single use disposable parts; do not submerge the device into any liquid, this will void the warranty and cause the device to malfunction.

### Disinfection

Use personal protective equipment such as gloves, a smock, and face and eye protection when handling units that are suspected to be contaminated.

**Caution:** Disconnect the unit from any power source prior to cleaning the unit. When cleaning the interior of the chassis, disconnect the battery from the PC Board to prevent damaging the PC Board.

Part	Cleaning and Disinfecting
Collection Canister	Disposable item, re-use not permitted. Use new canister for each patient.
Patient Tubing	Disposable item, re-use not permitted. Use new patient tubing for each patient.
HI-D® Stick	Disposable item, re-use not permitted. Use new HI-D Stick for each patient.
Vacuum Pump	Wipe with damp cloth or disinfectant wipe. Sterilization not permitted. Vacuum pump should be replaced if contaminated
PC Board	Sterilization not permitted. PC Board should be replaced if contaminated
Plastic Chassis	Wipe with damp cloth or disinfectant wipe. Sterilization not permitted.



*Clearing The Airway Is Our #1 Priority*

## **Retention Bracket Mounting Instructions**

---

The Model 8310 Charging/Retention bracket can be mounted by the base or mounted vertically in order to hold the SSCOR VX-2 portable suction unit. Mount the retention bracket to a suitable safe mounting surface so the indicator lights on the control panel are visible to the user. The unit is shipped ready to be mounted vertically, but if that does not fit your requirements, you can easily modify the unit to mount it by the base. Note: the mounting bracket will hold the VX-2 in place to a force of 25G. Select and prepare a mounting surface, and take care in the mounting procedure, so the bracket and pump will be secure at a force equal to, or greater than, 25G.

### **Vertical Mount**

Remove the four ¼-20 x 1-1/2" hex head screws from hardware packet. Mark the hole placement for a vertical mount and use a 5/16" drill to drill the holes. Coat the screws with Loctite (not supplied) before securing the Charging/Retention Bracket. Put the four 1-1/2" screws through the holes in the charging bracket (Model 8323). Reattach the washers and nuts to the screws to secure the Charging/Retention bracket in place.

### **Base Mount (Using part #8314-7)**

Mark the hole placement for a base mount and use a 5/16" drill to drill the holes. Remove the hardware from the hardware packet. Coat the screws with Loctite (not supplied) and place the screws through the bottom of the Bracket, Retention - Counter Mount (#8314-7) and through the holes you have drilled. Re-attach the washers and nuts to secure the Bracket, Retention – Counter Mount (#8314-7) in place. Mount the charging bracket (Model 8323) to the base mount (#8314-7) using the hardware in the hardware packet. Coat the screws with Loctite (not supplied) before securing the Charging/Retention Bracket to the base mount bracket (#8314-7).

### **Electrical**

Hard wire the Charging / Retention Bracket to the DC Electrical System of the vehicle in front of the master switch. Make certain that the circuit is properly fused according to appropriate vehicle standards.