

Count	Description
1	<p data-bbox="225 338 427 360">NBS 040-095/7.72</p>  <p data-bbox="619 636 1061 658">Product photo could vary from the actual product</p> <p data-bbox="225 667 488 689">Product No.: 92560328</p> <p data-bbox="225 757 1426 808">The pumps are non-self-priming, single-stage, centrifugal volute pumps with axial inlet port, radial outlet port and horizontal shaft.</p> <p data-bbox="225 815 1377 866">The pump has a back pull-out design enabling removal of the motor, motor stool, cover and impeller without disturbing the pump housing or pipework.</p> <p data-bbox="225 873 1386 902">All pumps are according to ISO 5199 standards, adjusted for American dimensions on pump and its flanges.</p> <p data-bbox="225 931 1417 983">Inlet and outlet flanges are according to ASME 16.1/16.42. Dimensions and rated performance are according to 175/363 PSI (12/25 bar).</p> <p data-bbox="225 1019 940 1048">The mechanical shaft seal has dimensions according to EN 12756.</p> <p data-bbox="225 1079 1372 1131">Motors are with main dimensions to NEMA standards. The pumps can be equipped with an MLE motor with integrated frequency converter or connected to a Grundfos CUE external frequency converter.</p>



Company name:

Created by:

Phone:

Date:

12/22/2021

92560328 NBS 040-095/7.72 AASG6S5ESBQQEVX2 60 Hz

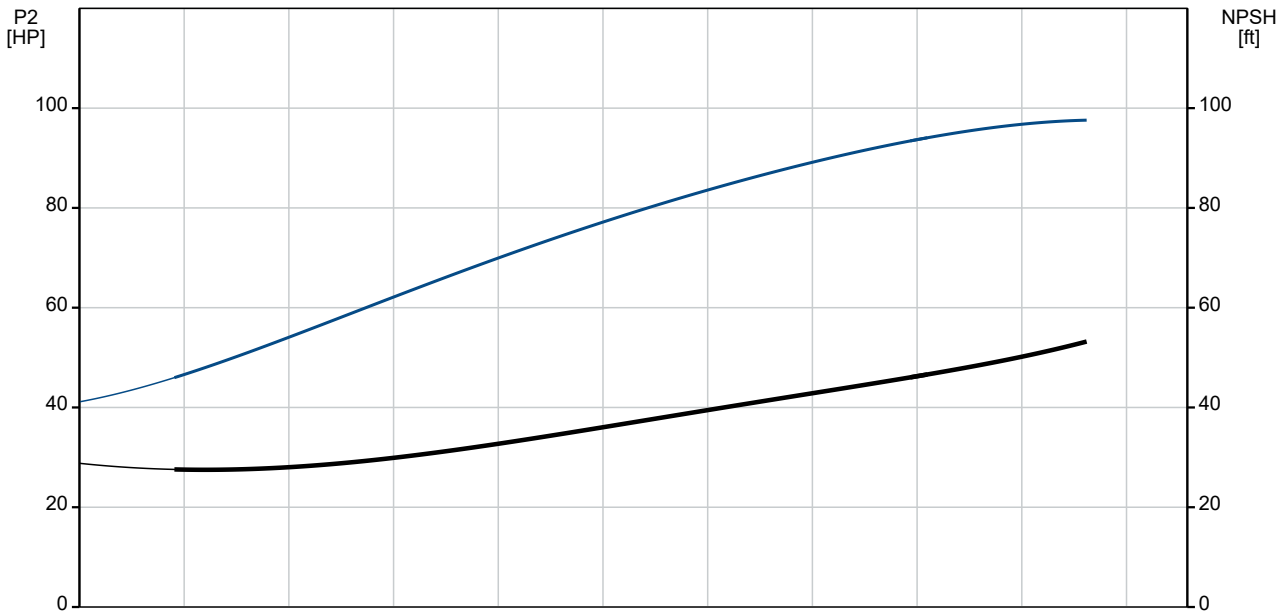
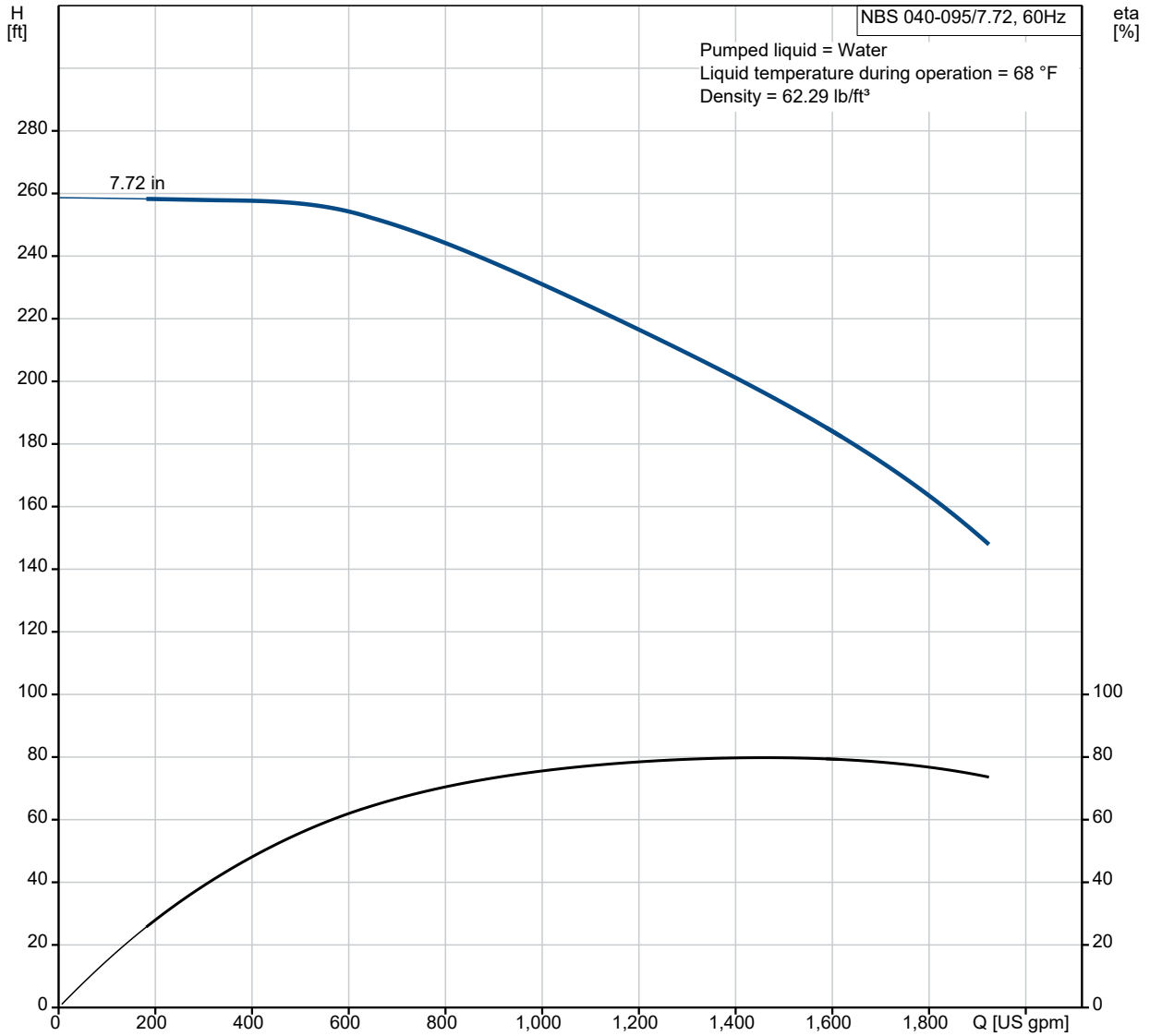

Description	Value
General information:	
Product name:	NBS 040-095/7.72 AASG6S5ESBQQEVX2
Product No.:	92560328
EAN:	5715116272078
Price:	
Technical:	
Rated pump speed:	3540 rpm
Rated flow:	1480 US gpm
Rated head:	194 ft
Actual impeller diameter:	7.72 in
Code for shaft seal:	BQQE
Curve tolerance:	2B HI 14.6:2016
Pump version:	A
Materials:	
Pump housing:	Cast iron
Pump housing:	EN-GJL-250
Pump housing:	ASTM A48-35
Impeller:	Stainless steel
Impeller:	EN 1.4308
Impeller:	AISI 304
Shaft:	Stainless steel
Shaft:	EN 1.4462
Shaft:	SAF 2205
Internal pump house coating:	No coating
Material code:	S5
Code for rubber:	E
Installation:	
t max amb:	104 °F
Maximum operating pressure:	174.05 psi
Type of connection:	ANSI
Size of inlet connection:	DN 125
Size of outlet connection:	DN 100
Pressure rating for connection:	Class 125
Mounting options design code:	C
Support block (Yes/No):	Y
Connect code:	G
Liquid:	
Pumped liquid:	Water
Liquid temperature range:	-13 .. 248 °F
Selected liquid temperature:	68 °F
Density:	62.29 lb/ft ³
Electrical data:	
Motor standard:	NEMA
IE efficiency class:	IE3 / NEMA Premium
Rated power - P2:	100 HP
Main frequency:	60 Hz
Rated voltage:	3 x 460 V
Rated current:	110 A
Rated speed:	3540 rpm
Number of poles:	2
Enclosure class (IEC 34-5):	TEFC
Mounting designation (IEC 34-7, Code I):	NEMA type C / foot
Others:	
DOE Pump Energy Index CL:	0.96
Net weight:	1520 lb
Gross weight:	1530 lb
Shipping volume:	26.6 ft ³

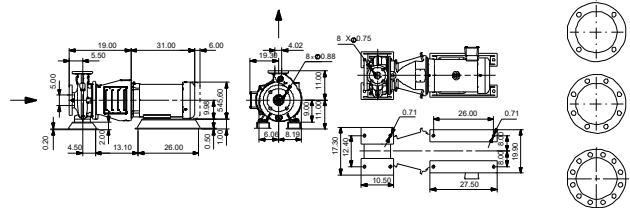
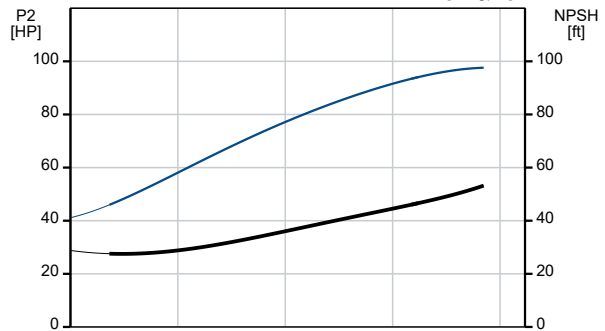
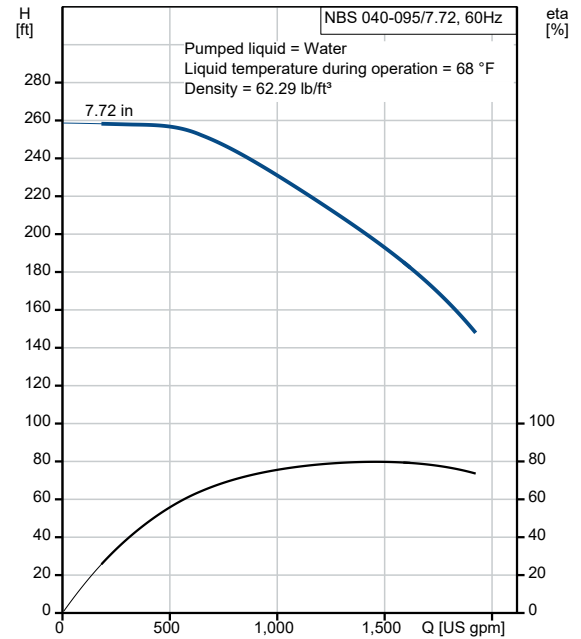



Company name:

Created by:

Phone:

Date:

12/22/2021

Description	Value
Country of origin:	US

92560328 NBS 040-095/7.72 AASG6S5ESBQQEVX2 60 Hz

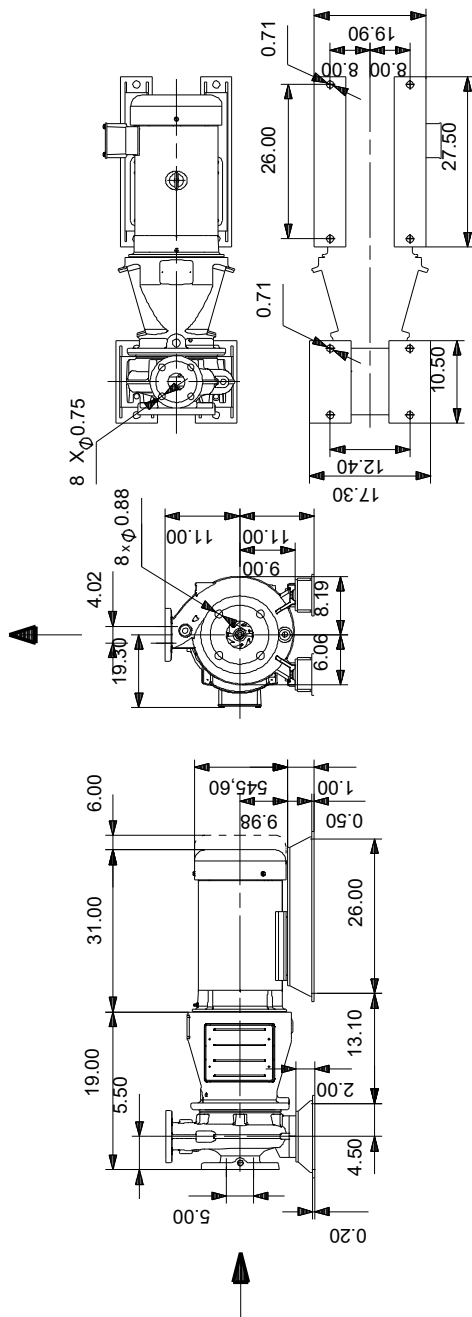
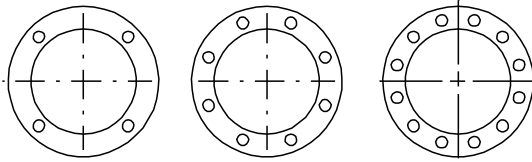

Note! All units are in [in] unless otherwise stated.
 Disclaimer: This simplified dimensional drawing does not show all details.