

Count	Description
1	<p data-bbox="225 338 427 365"><b>NBS 030-070/5.83</b></p>  <p data-bbox="619 636 1061 663">Product photo could vary from the actual product</p> <p data-bbox="225 669 488 696">Product No.: <a href="#">92560302</a></p> <p data-bbox="225 757 1428 808">The pumps are non-self-priming, single-stage, centrifugal volute pumps with axial inlet port, radial outlet port and horizontal shaft.</p> <p data-bbox="225 815 1377 866">The pump has a back pull-out design enabling removal of the motor, motor stool, cover and impeller without disturbing the pump housing or pipework.</p> <p data-bbox="225 873 1386 900">All pumps are according to ISO 5199 standards, adjusted for American dimensions on pump and its flanges.</p> <p data-bbox="225 931 1417 983">Inlet and outlet flanges are according to ASME 16.1/16.42. Dimensions and rated performance are according to 175/363 PSI (12/25 bar).</p> <p data-bbox="225 1019 940 1046">The mechanical shaft seal has dimensions according to EN 12756.</p> <p data-bbox="225 1077 1372 1128">Motors are with main dimensions to NEMA standards. The pumps can be equipped with an MLE motor with integrated frequency converter or connected to a Grundfos CUE external frequency converter.</p>



Company name:

Created by:

Phone:

Date:

1/2/2022

### 92560302 NBS 030-070/5.83 AASG6S2ESBQQEPX2 60 Hz

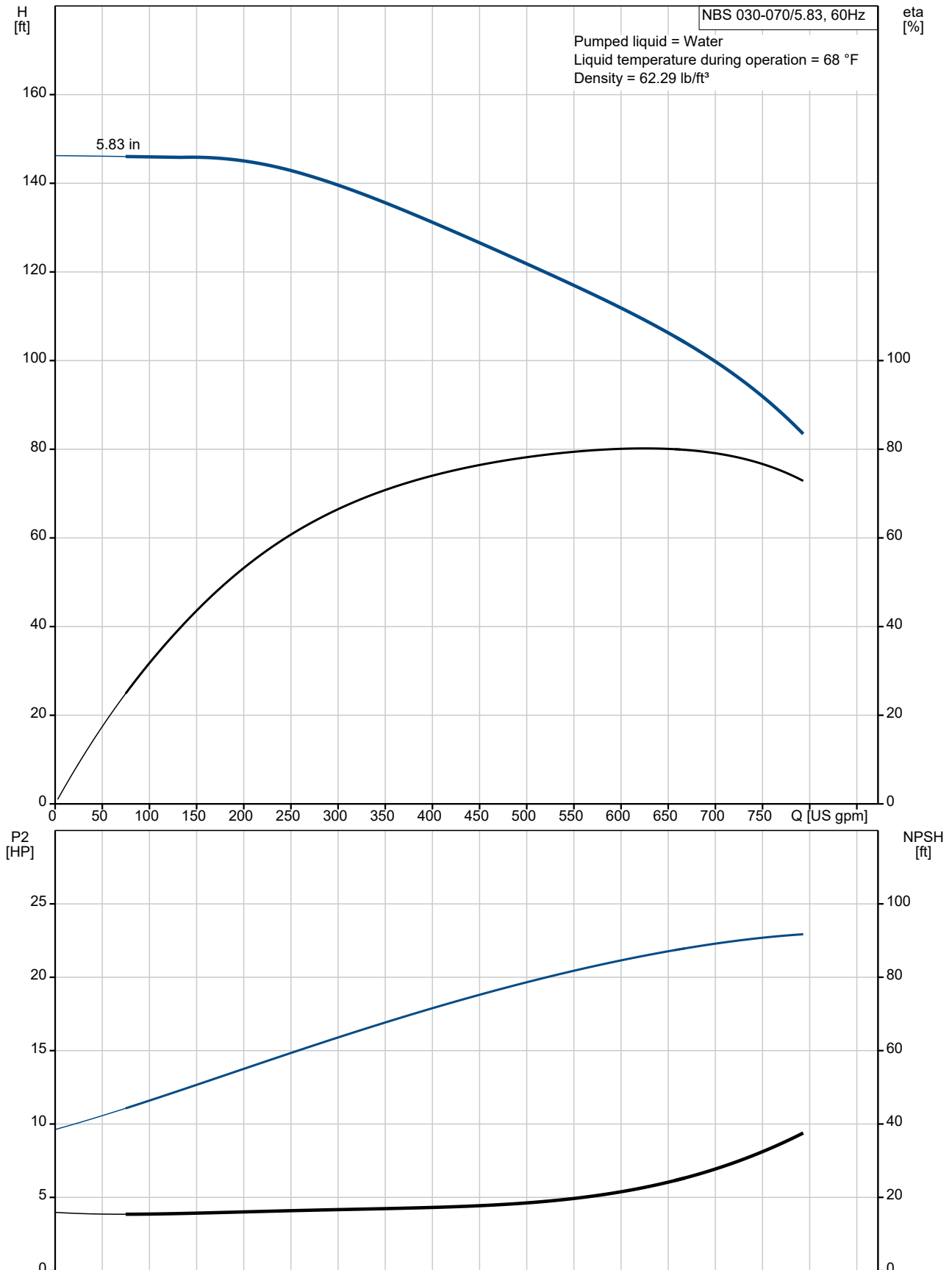

Description	Value
<b>General information:</b>	
Product name:	NBS 030-070/5.83 AASG6S2ESBQQEPX2
Product No.:	92560302
EAN:	5715116271651
Price:	
<b>Technical:</b>	
Rated pump speed:	3515 rpm
Rated flow:	624 US gpm
Rated head:	108.6 ft
Actual impeller diameter:	5.83 in
Code for shaft seal:	BQQE
Curve tolerance:	2B HI 14.6:2016
Pump version:	A
<b>Materials:</b>	
Pump housing:	Cast iron
Pump housing:	EN-GJL-250
Pump housing:	ASTM A48-35
Impeller:	Stainless steel
Impeller:	EN 1.4308
Impeller:	AISI 304
Shaft:	Stainless steel
Shaft:	EN 1.4201/1.4034
Shaft:	AISI 420
Internal pump house coating:	No coating
Material code:	S2
Code for rubber:	E
<b>Installation:</b>	
t max amb:	104 °F
Maximum operating pressure:	174.05 psi
Type of connection:	ANSI
Size of inlet connection:	DN 100
Size of outlet connection:	DN 80
Pressure rating for connection:	Class 125
Mounting options design code:	C
Support block (Yes/No):	Y
Connect code:	G
<b>Liquid:</b>	
Pumped liquid:	Water
Liquid temperature range:	-13 .. 248 °F
Selected liquid temperature:	68 °F
Density:	62.29 lb/ft <sup>3</sup>
<b>Electrical data:</b>	
Motor standard:	NEMA
IE efficiency class:	IE3 / NEMA Premium
Rated power - P2:	25 HP
Main frequency:	60 Hz
Rated voltage:	3 x 230/460 V
Rated current:	58-29 A
Rated speed:	3515 rpm
Number of poles:	2
Enclosure class (IEC 34-5):	TEFC
Mounting designation (IEC 34-7, Code I):	NEMA type C / foot
<b>Others:</b>	
DOE Pump Energy Index CL:	0.92
Net weight:	603 lb
Gross weight:	605 lb
Shipping volume:	10.6 ft <sup>3</sup>

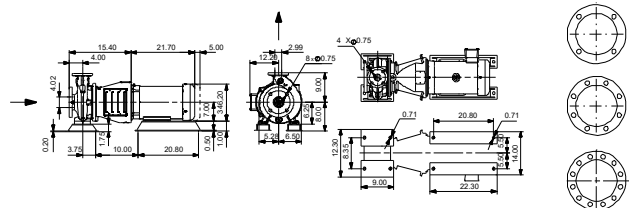
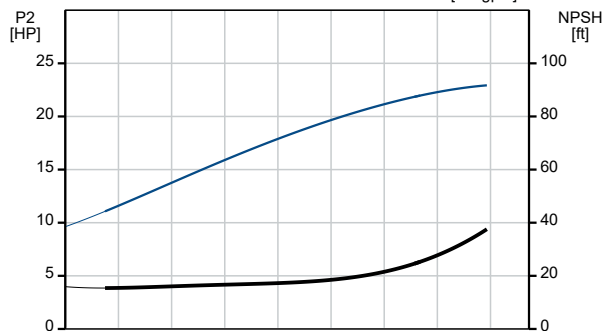
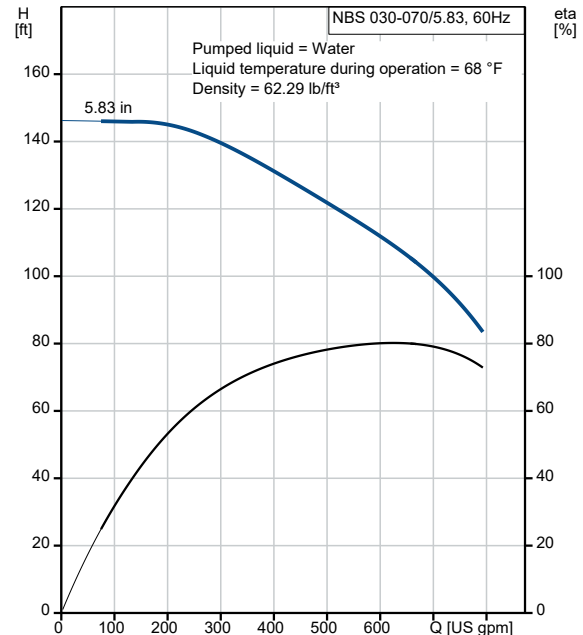



Company name:

Created by:

Phone:

Date:

1/2/2022

Description	Value
Country of origin:	US

## 92560302 NBS 030-070/5.83 AASG6S2ESBQQEPX2 60 Hz

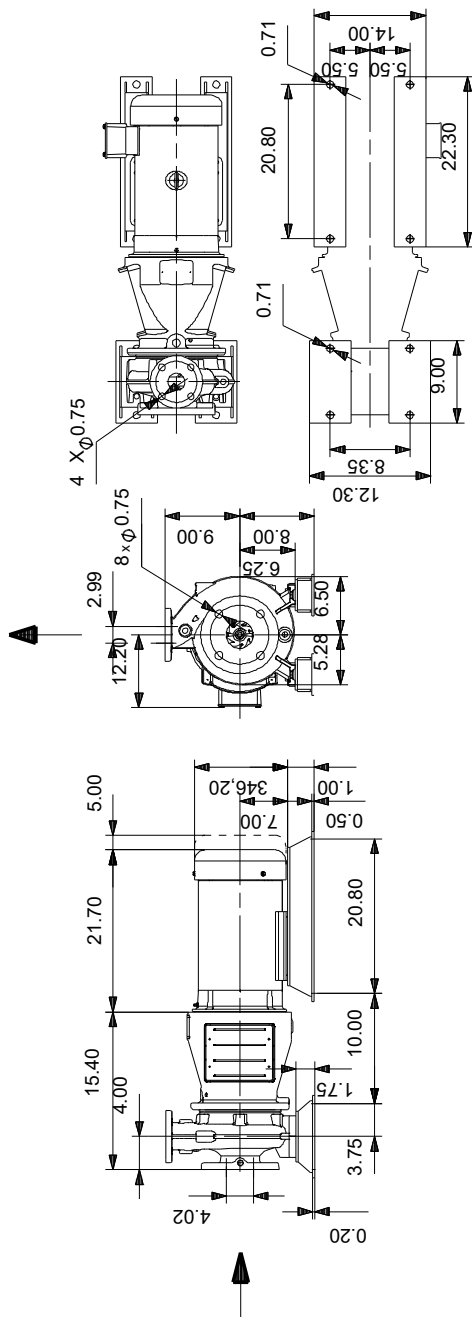
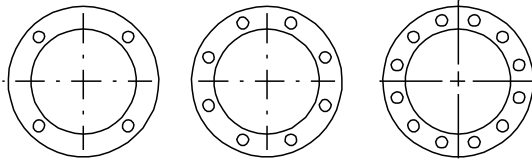

Note! All units are in [in] unless otherwise stated.  
Disclaimer: This simplified dimensional drawing does not show all details.