

Count	Description
1	<p data-bbox="225 338 427 360">NBS 030-135/9.92</p>  <p data-bbox="619 636 1061 658">Product photo could vary from the actual product</p> <p data-bbox="225 667 486 689">Product No.: 92559694</p> <p data-bbox="225 757 1428 808">The pumps are non-self-priming, single-stage, centrifugal volute pumps with axial inlet port, radial outlet port and horizontal shaft.</p> <p data-bbox="225 815 1380 866">The pump has a back pull-out design enabling removal of the motor, motor stool, cover and impeller without disturbing the pump housing or pipework.</p> <p data-bbox="225 873 1388 902">All pumps are according to ISO 5199 standards, adjusted for American dimensions on pump and its flanges.</p> <p data-bbox="225 931 1417 983">Inlet and outlet flanges are according to ASME 16.1/16.42. Dimensions and rated performance are according to 175/363 PSI (12/25 bar).</p> <p data-bbox="225 1019 938 1048">The mechanical shaft seal has dimensions according to EN 12756.</p> <p data-bbox="225 1079 1372 1131">Motors are with main dimensions to NEMA standards. The pumps can be equipped with an MLE motor with integrated frequency converter or connected to a Grundfos CUE external frequency converter.</p>



Company name:

Created by:

Phone:

Date:

12/22/2021

92559694 NBS 030-135/9.92 AASG6S2ESBQQEOX4 60 Hz

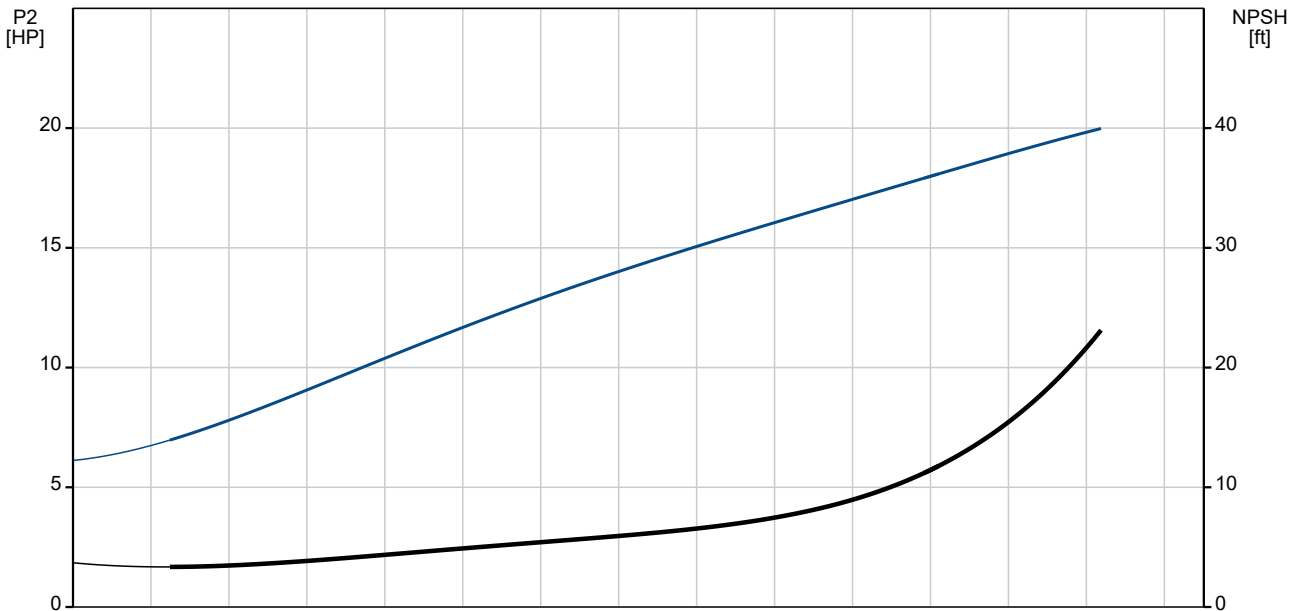
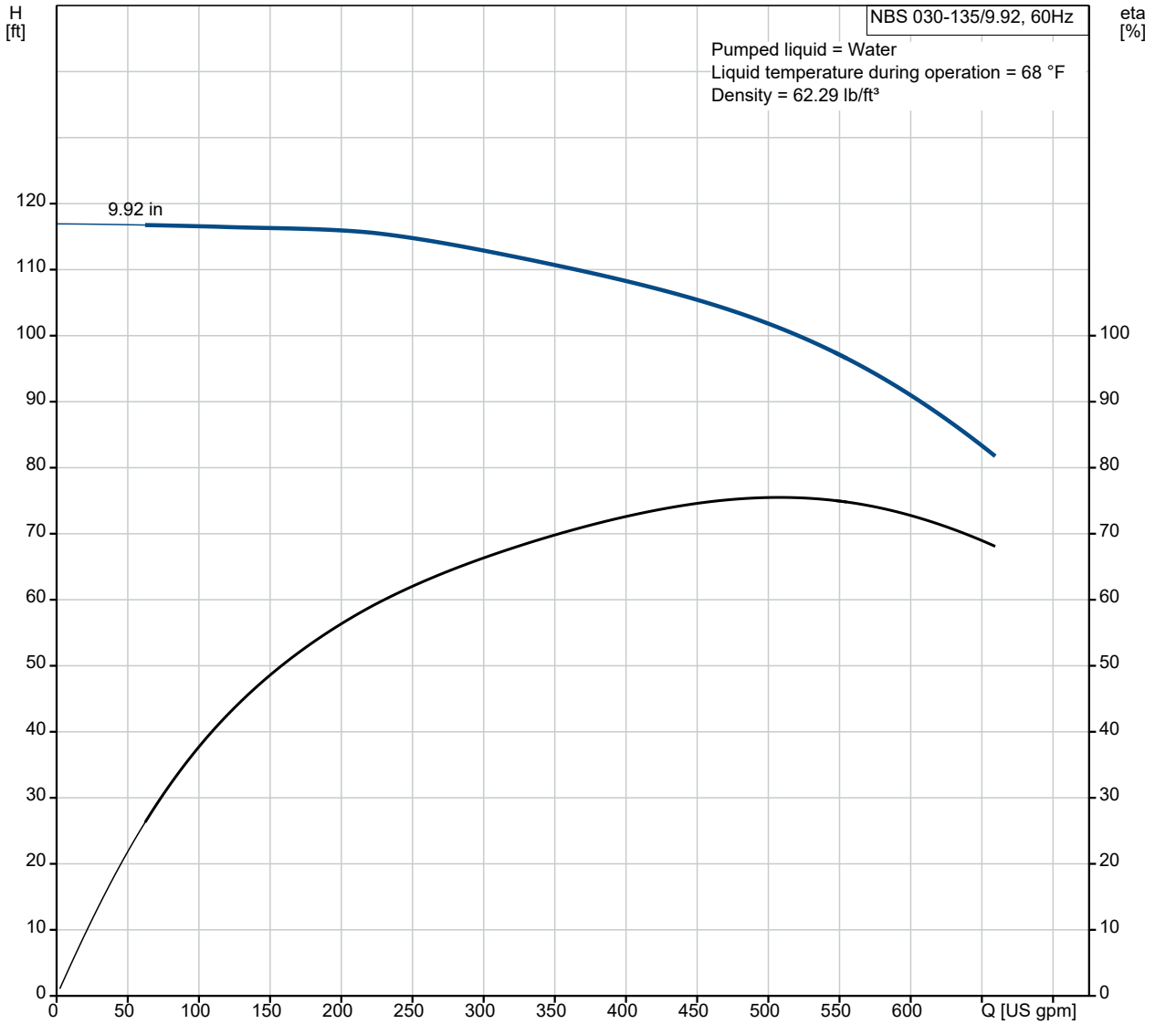



Company name:

Created by:

Phone:

Date:

12/22/2021

Description	Value
Country of origin:	US

92559694 NBS 030-135/9.92 AASG6S2ESBQQEOX4 60 Hz

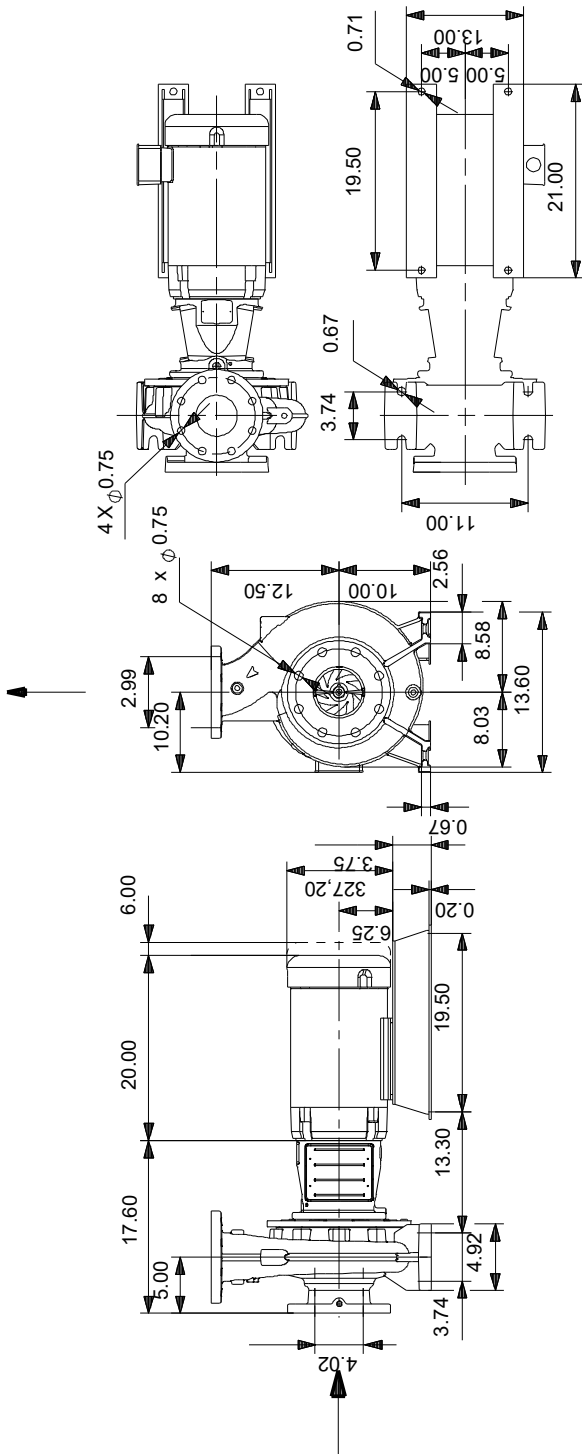

Note! All units are in [in] unless otherwise stated.
 Disclaimer: This simplified dimensional drawing does not show all details.