

Count	Description
1	<p data-bbox="225 338 427 365">NBS 012-070/4.69</p>  <p data-bbox="619 629 1062 656">Product photo could vary from the actual product</p> <p data-bbox="225 663 502 689">Product No.: On request</p> <p data-bbox="225 750 1428 801">The pumps are non-self-priming, single-stage, centrifugal volute pumps with axial inlet port, radial outlet port and horizontal shaft.</p> <p data-bbox="225 808 1377 860">The pump has a back pull-out design enabling removal of the motor, motor stool, cover and impeller without disturbing the pump housing or pipework.</p> <p data-bbox="225 866 1386 896">All pumps are according to ISO 5199 standards, adjusted for American dimensions on pump and its flanges.</p> <p data-bbox="225 925 1417 976">Inlet and outlet flanges are according to ASME 16.1/16.42. Dimensions and rated performance are according to 175/363 PSI (12/25 bar).</p> <p data-bbox="225 1014 940 1041">The mechanical shaft seal has dimensions according to EN 12756.</p> <p data-bbox="225 1070 1372 1122">Motors are with main dimensions to NEMA standards. The pumps can be equipped with an MLE motor with integrated frequency converter or connected to a Grundfos CUE external frequency converter.</p>



Company name:

Created by:

Phone:

Date:

12/18/2021

On request NBS 012-070/4.69 AASG6S2ESBQQEIX2 60 Hz

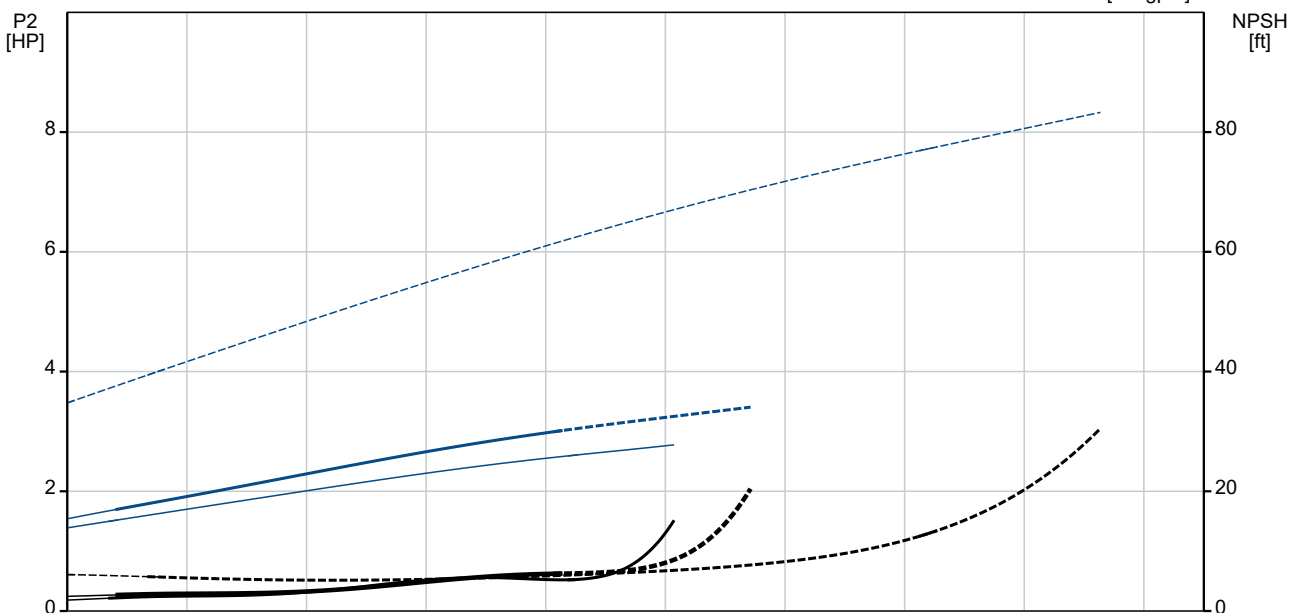
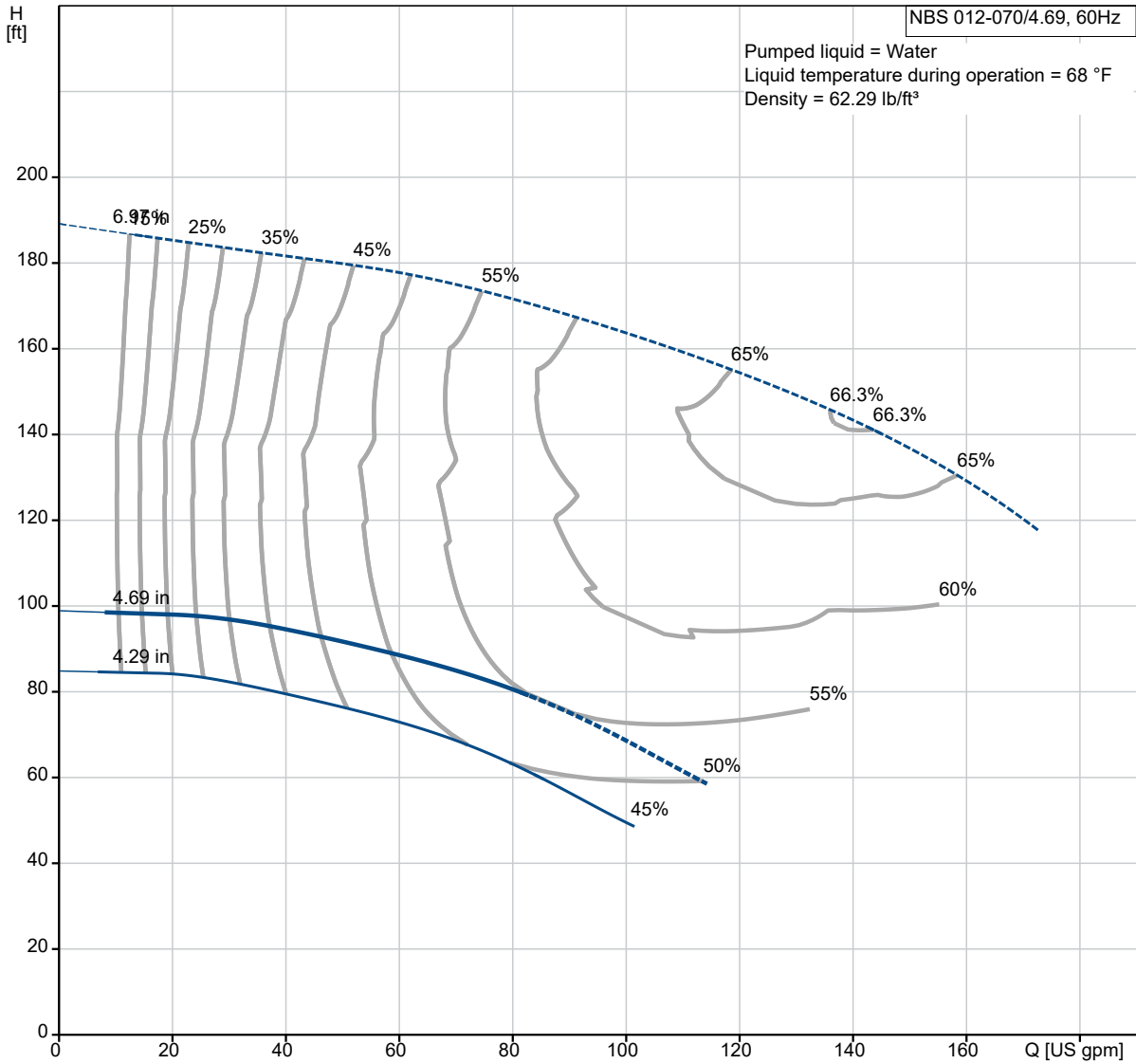

Description	Value
General information:	
Product name:	NBS 012-070/4.69 AASG6S2ESBQQEIX2
Product No.:	On request
EAN:	On request
Price:	
Technical:	
Rated pump speed:	3450 rpm
Rated flow:	88.2 US gpm
Rated head:	72.71 ft
Actual impeller diameter:	4.69 in
Code for shaft seal:	BQQE
Curve tolerance:	2B HI 14.6:2016
Pump version:	A
Materials:	
Pump housing:	Cast iron
Pump housing:	EN-GJL-250
Pump housing:	ASTM A48-35
Impeller:	Stainless steel
Impeller:	EN 1.4308
Impeller:	AISI 304
Shaft:	Stainless steel
Shaft:	EN 1.4201/1.4034
Shaft:	AISI 420
Internal pump house coating:	No coating
Material code:	S2
Code for rubber:	E
Installation:	
t max amb:	104 °F
Maximum operating pressure:	174.05 psi
Type of connection:	ANSI
Size of inlet connection:	DN 50
Size of outlet connection:	DN 32
Pressure rating for connection:	Class 125
Mounting options design code:	C
Support block (Yes/No):	Y
Connect code:	G
Liquid:	
Pumped liquid:	Water
Liquid temperature range:	-13 .. 248 °F
Selected liquid temperature:	68 °F
Density:	62.29 lb/ft ³
Electrical data:	
Motor standard:	NEMA
IE efficiency class:	IE3 / NEMA Premium
Rated power - P2:	3 HP
Main frequency:	60 Hz
Rated voltage:	3 x 230/460 V
Rated current:	7.2-3.6 A
Rated speed:	3450 rpm
Number of poles:	2
Enclosure class (IEC 34-5):	TEFC
Mounting designation (IEC 34-7, Code I):	NEMA type C / foot
Others:	
DOE Pump Energy Index CL:	0.84
Net weight:	237 lb
Gross weight:	240 lb
Shipping volume:	4.56 ft ³

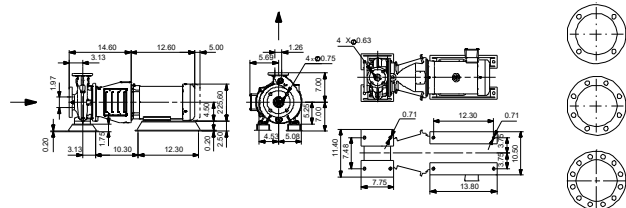
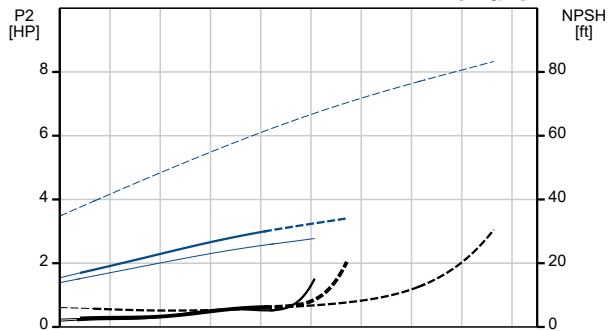
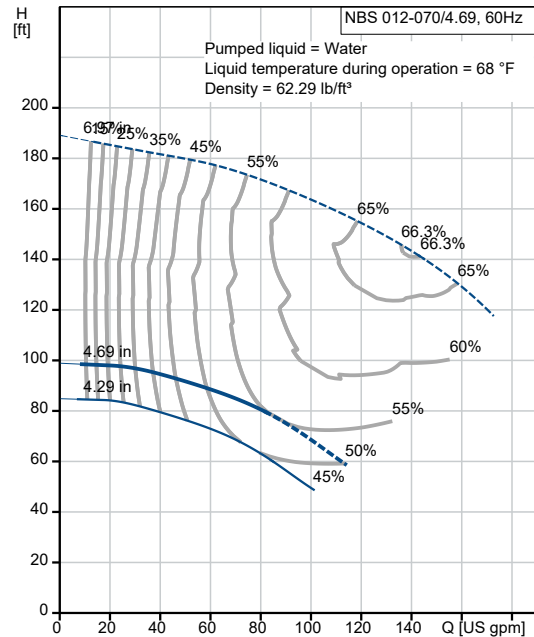



Company name:

Created by:

Phone:

Date:

12/18/2021

Description

Value

Country of origin:

US

On request NBS 012-070/4.69 AASG6S2ESBQQEIX2 60 Hz

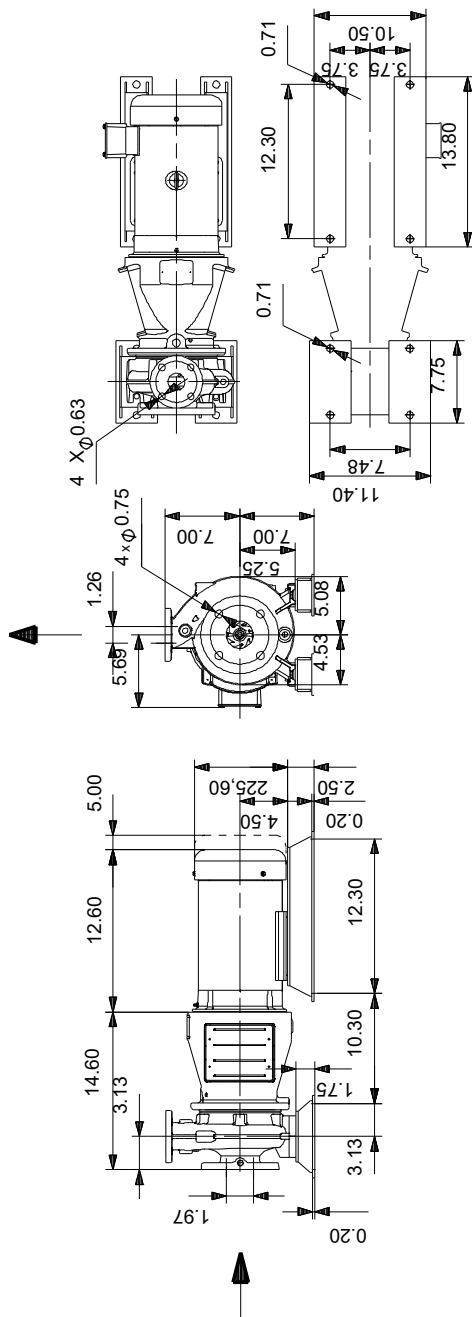
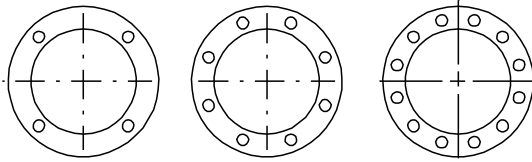

Note! All units are in [in] unless otherwise stated.
Disclaimer: This simplified dimensional drawing does not show all details.