

Qty.	Description
------	-------------

1	NBSE 012-070/5.00
---	--------------------------



Note! Product picture may differ from actual product

Product No.: [92617389](#)

The pumps are non-self-priming, single-stage, centrifugal volute pumps with axial inlet port, radial outlet port and horizontal shaft.

The pump has a back pull-out design enabling removal of the motor, motor stool, cover and impeller without disturbing the pump housing or pipework.

All pumps are according to ISO 5199 standards, adjusted for American dimensions on pump and its flanges.

Inlet and outlet flanges are according to ASME 16.1/16.42. Dimensions and rated performance are according to 175/363 PSI (12/25 bar).

The mechanical shaft seal has dimensions according to EN 12756.

Motors are with main dimensions to NEMA standards. The pumps can be equipped with an MLE motor with integrated frequency converter or connected to a Grundfos CUE external frequency converter.

92617389 NBSE 012-070/5.00 ASASG6S2ESBQQEKBB 60 Hz

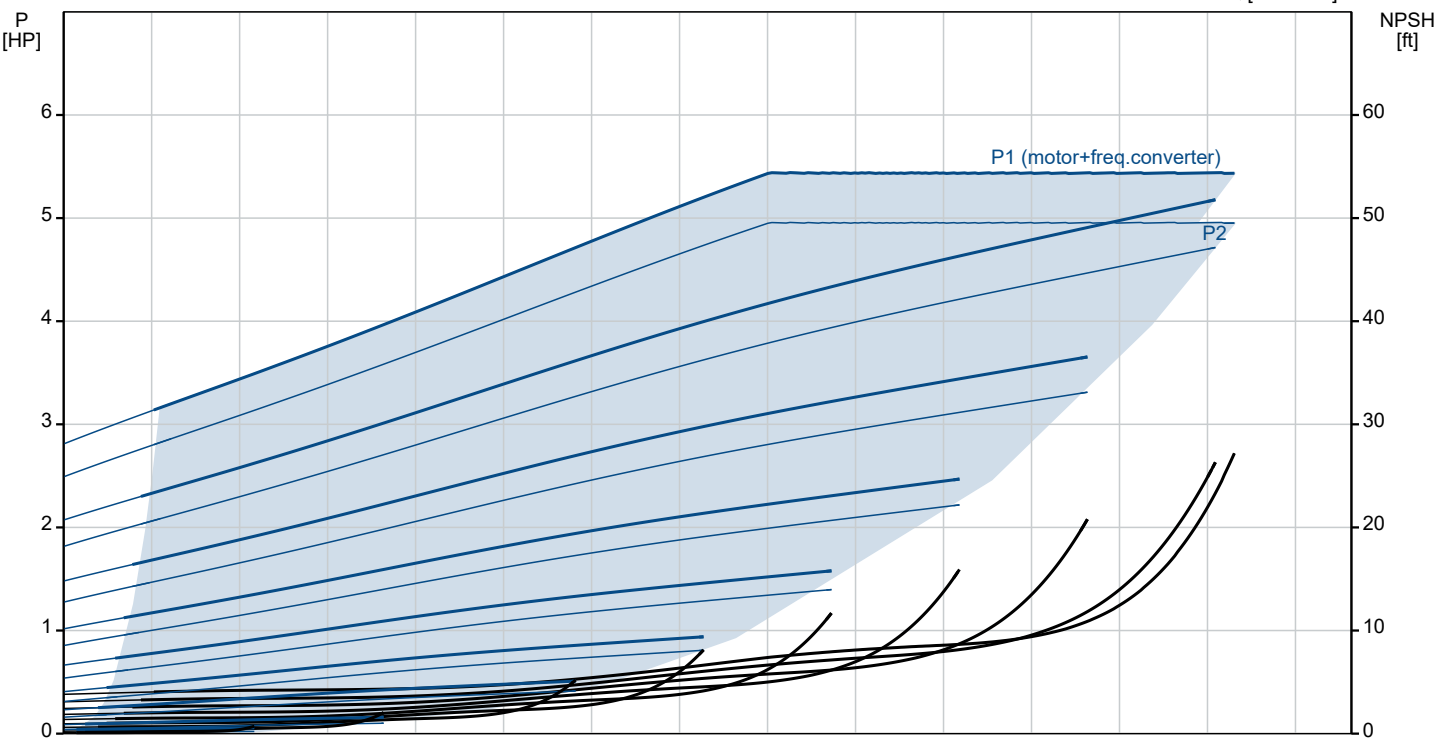
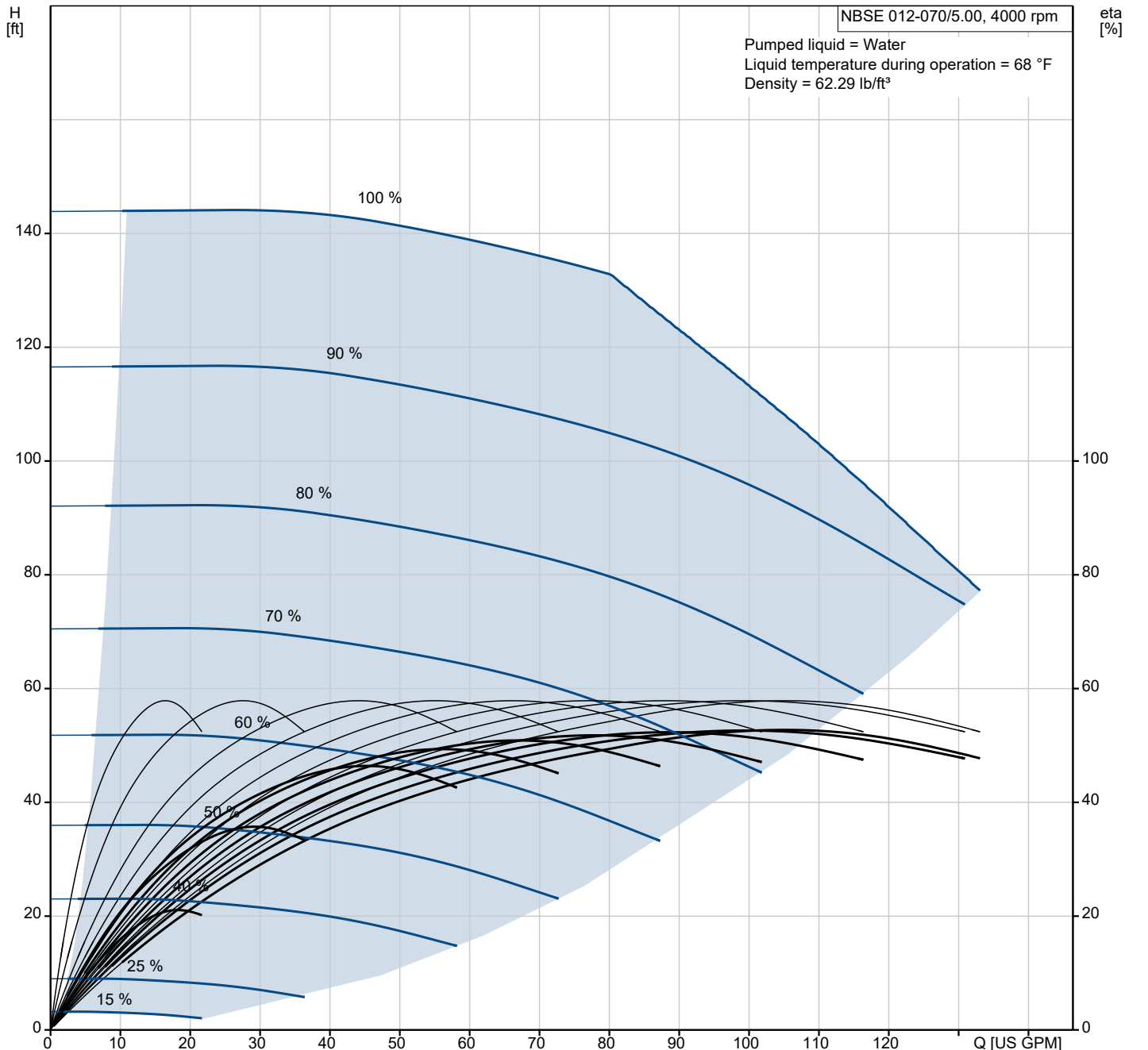

Description	Value
General information:	
Product name:	NBSE 012-070/5.00 ASAG6S2ESBQQEKBB
Product No:	92617389
EAN number:	5715117136089
Technical:	
Pump speed on which pump data are based:	4000 rpm
Rated flow:	112 US GPM
Rated head:	109.3 ft
Actual impeller diameter:	5 in
Code for shaft seal:	BQQE
Curve tolerance:	2B HI 14.6:2016
Pump version:	A
Materials:	
Pump housing:	Cast iron
Pump housing:	EN-GJL-250
Pump housing:	ASTM A48-35
Impeller:	Stainless steel
Impeller:	EN 1.4308
Impeller:	AISI 304
Internal pump house coating:	No coating
Material code:	S2
Code for rubber:	E
Shaft:	Stainless steel
Shaft:	EN 1.4201/1.4034
Shaft:	AISI 420
Installation:	
t max amb:	104 °F
Maximum operating pressure:	174.05 psi
Type of connection:	ANSI
Size of inlet connection:	DN 50
Size of outlet connection:	DN 32
Pressure rating for connection:	Class 125
Mounting options design code:	C
Support block (Yes/No):	Y
Connect code:	G
Liquid:	
Pumped liquid:	Water
Liquid temperature range:	-13 .. 248 °F
Selected liquid temperature:	68 °F
Density:	62.29 lb/ft³
Electrical data:	
Motor standard:	NEMA
Motor type:	112C
IE efficiency class:	IE5
Rated power - P2:	5 HP
Mains frequency:	60 Hz
Rated voltage:	3 x 200-240 V
Rated current:	13.2-10.9 A
Cos phi - power factor:	0.94
Rated speed:	360-4000 rpm
Efficiency:	90.9%
Motor efficiency at full load:	90.9 %
Number of poles:	2
Enclosure class (IEC 34-5):	IP55
Insulation class (IEC 85):	F
Built-in motor protection:	ELEC
Motor No:	99302133
Mounting designation (IEC 34-7, Code I):	NEMA type C / foot
Bearing insulation type N-end:	STEEL BEARING
Controls:	
Control panel:	HMI300 - Advanced
Function Module:	FM300 - Advanced
Others:	
DOE Pump Energy Index VL:	0.43
Net weight:	244 lb
Gross weight:	247 lb
Shipping volume:	4.8 ft³

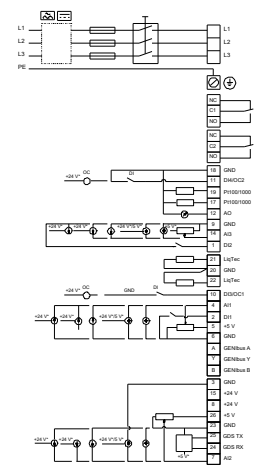
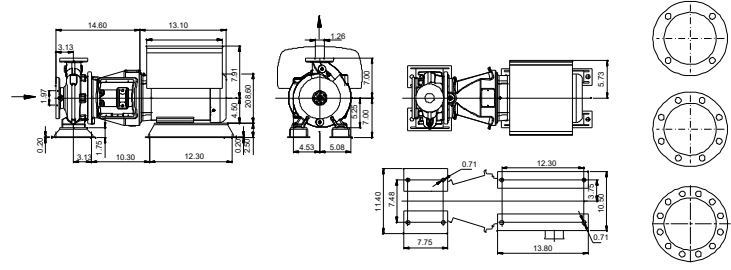
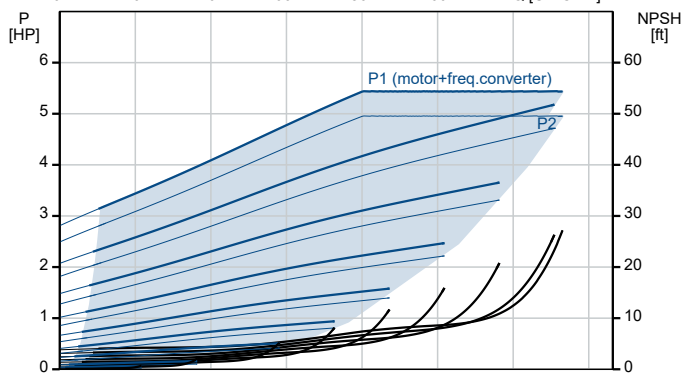
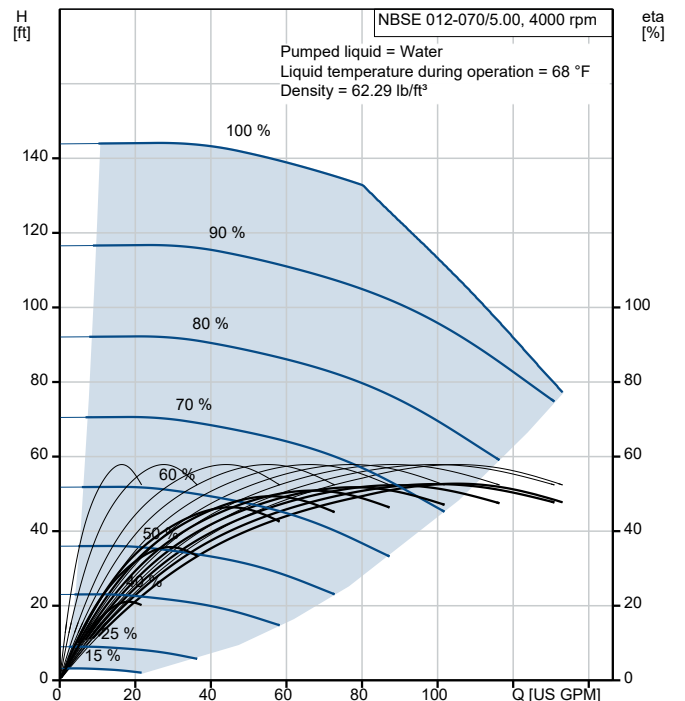

92617389 NBSE 012-070/5.00 ASASG6S2ESBQQEKBB 60 Hz

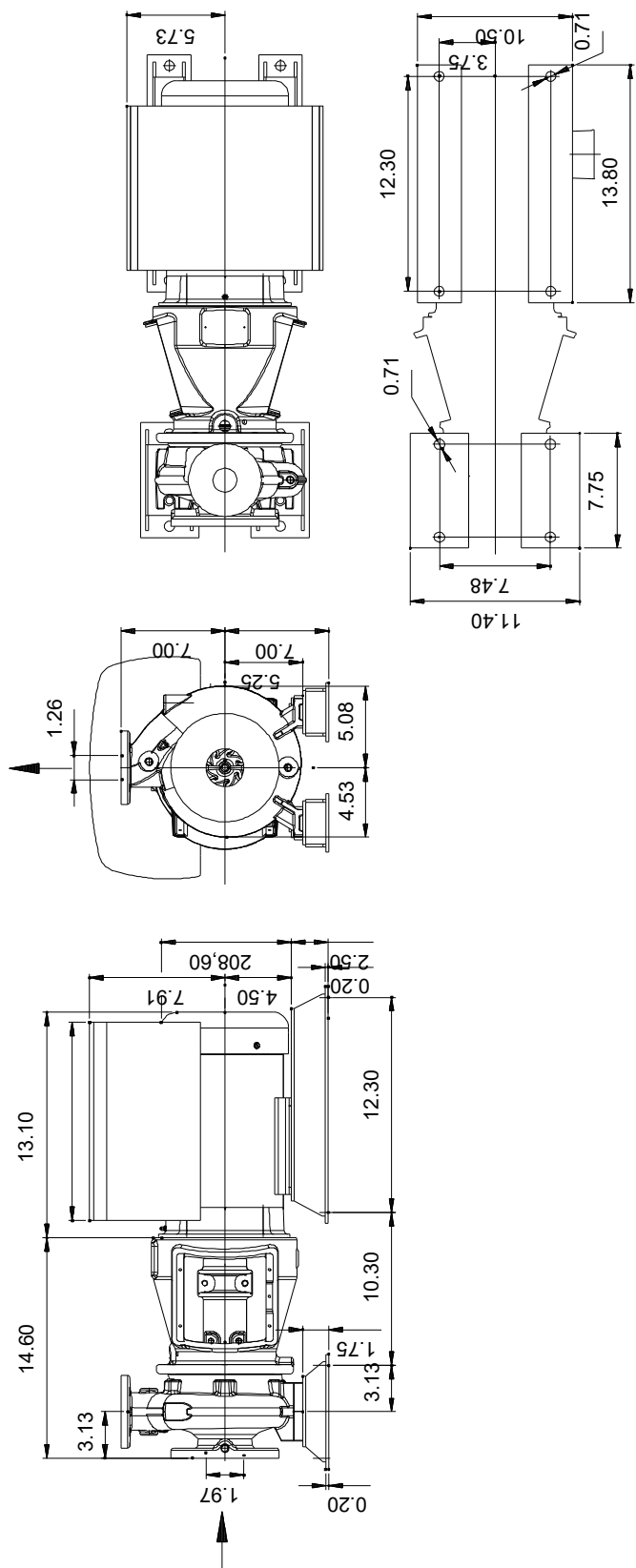
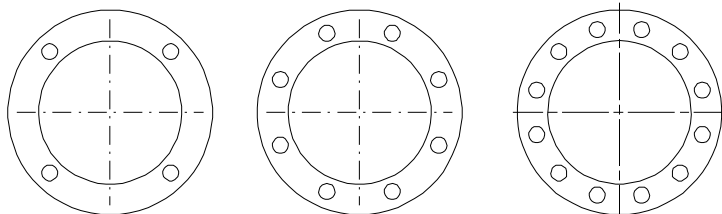

Note! All units are in [in] unless others are stated
 Disclaimer: This simplified dimensional drawing does not show all details.

92617389 NBSE 012-070/5.00 ASASG6S2ESBQQEKBB 60 Hz



Note! All units are in [in] unless others are stated.