

Qty.	Description
------	-------------

1	NBSE 025-070/6.61
---	--------------------------



Note! Product picture may differ from actual product

Product No.: [92613454](#)

The pumps are non-self-priming, single-stage, centrifugal volute pumps with axial inlet port, radial outlet port and horizontal shaft.

The pump has a back pull-out design enabling removal of the motor, motor stool, cover and impeller without disturbing the pump housing or pipework.

All pumps are according to ISO 5199 standards, adjusted for American dimensions on pump and its flanges.

Inlet and outlet flanges are according to ASME 16.1/16.42. Dimensions and rated performance are according to 175/363 PSI (12/25 bar).

The mechanical shaft seal has dimensions according to EN 12756.

Motors are with main dimensions to NEMA standards. The pumps can be equipped with an MLE motor with integrated frequency converter or connected to a Grundfos CUE external frequency converter.

92613454 NBSE 025-070/6.61 ASASG6S2ESBQQEICA 60 Hz

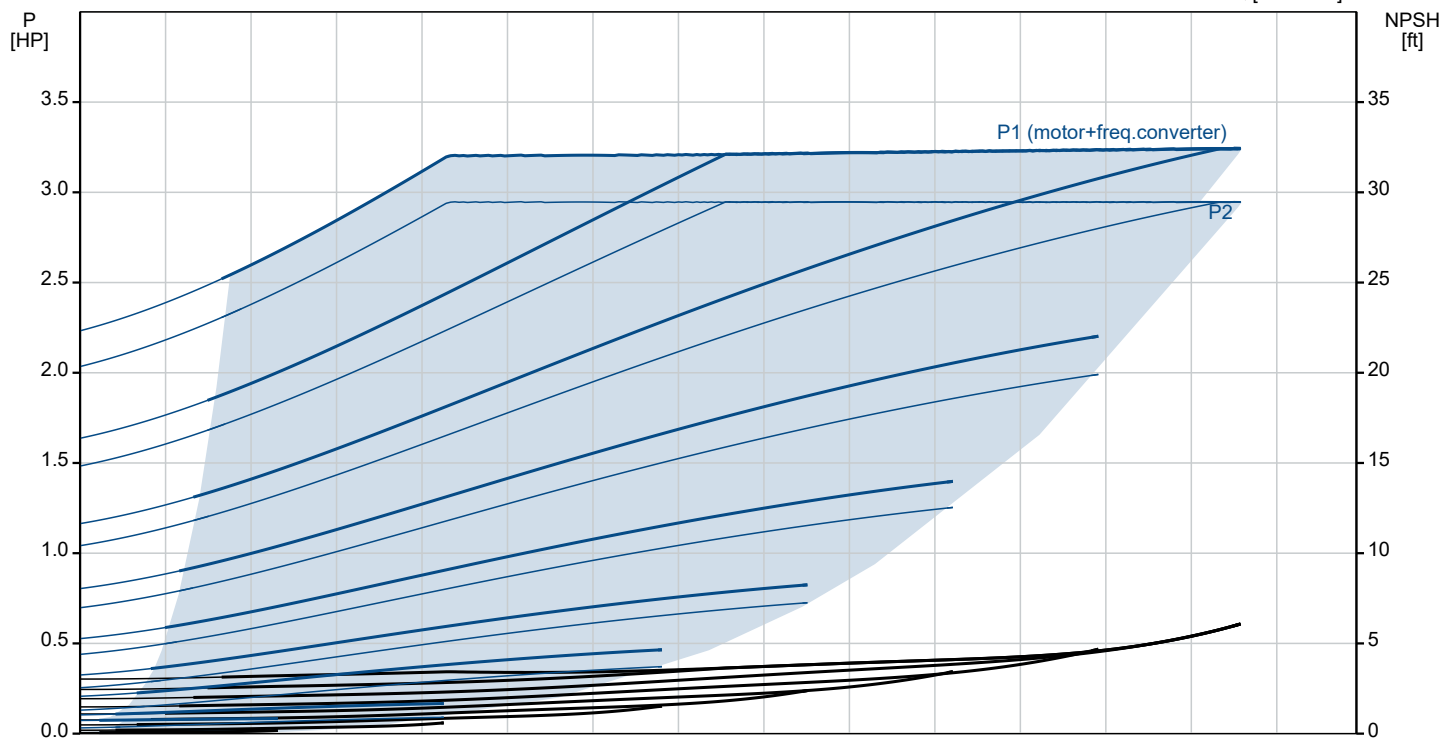
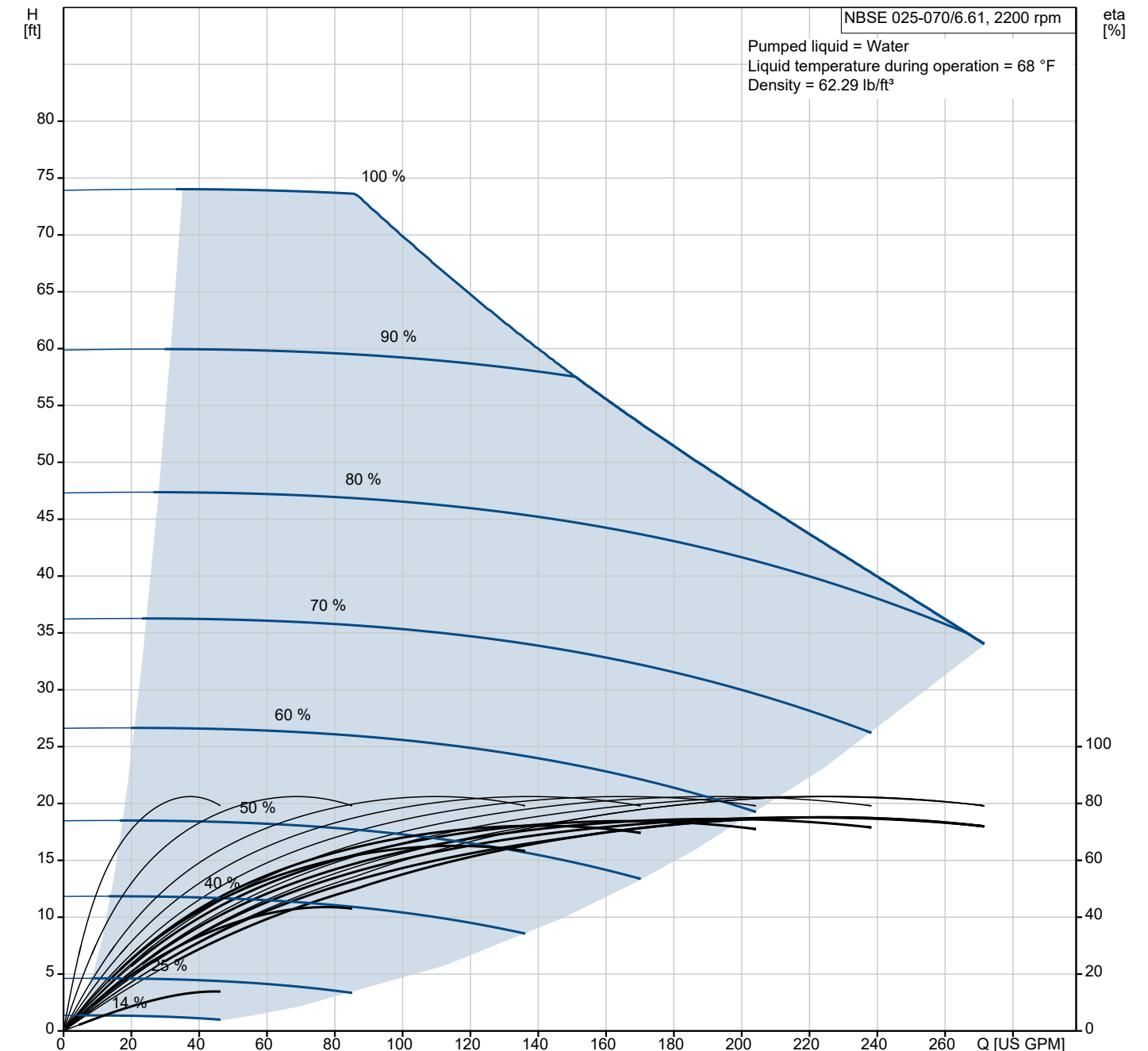

Description	Value
General information:	
Product name:	NBSE 025-070/6.61 ASAG6S2ESBQQEICA
Product No:	92613454
EAN number:	5715117077580
Technical:	
Pump speed on which pump data are based:	2200 rpm
Rated flow:	226 US GPM
Rated head:	42.69 ft
Actual impeller diameter:	6.61 in
Code for shaft seal:	BQQE
Curve tolerance:	2B HI 14.6:2016
Pump version:	A
Materials:	
Pump housing:	Cast iron
Pump housing:	EN-GJL-250
Pump housing:	ASTM A48-35
Impeller:	Stainless steel
Impeller:	EN 1.4308
Impeller:	AISI 304
Internal pump house coating:	No coating
Material code:	S2
Code for rubber:	E
Shaft:	Stainless steel
Shaft:	EN 1.4201/1.4034
Shaft:	AISI 420
Installation:	
t max amb:	122 °F
Maximum operating pressure:	174.05 psi
Type of connection:	ANSI
Size of inlet connection:	DN 80
Size of outlet connection:	DN 65
Pressure rating for connection:	Class 125
Mounting options design code:	C
Support block (Yes/No):	Y
Connect code:	G
Liquid:	
Pumped liquid:	Water
Liquid temperature range:	-13 .. 248 °F
Selected liquid temperature:	68 °F
Density:	62.29 lb/ft ³
Electrical data:	
Motor standard:	NEMA
Motor type:	100B
IE efficiency class:	IE5
Rated power - P2:	3 HP
Mains frequency:	60 Hz
Rated voltage:	3 x 440-480 V
Rated current:	3.90-3.70 A
Cos phi - power factor:	0.87-0.83
Rated speed:	180-2200 rpm
Efficiency:	91.1%
Motor efficiency at full load:	91.1 %
Number of poles:	4
Enclosure class (IEC 34-5):	IP55
Insulation class (IEC 85):	F
Built-in motor protection:	ELEC
Motor No:	99198279
Mounting designation (IEC 34-7, Code I):	NEMA type C / foot
Bearing insulation type N-end:	STEEL BEARING
Controls:	
Control panel:	HMI300 - Advanced
Function Module:	FM300 - Advanced
Others:	
DOE Pump Energy Index VL:	0.41
Net weight:	252 lb
Gross weight:	254 lb
Shipping volume:	5.12 ft ³

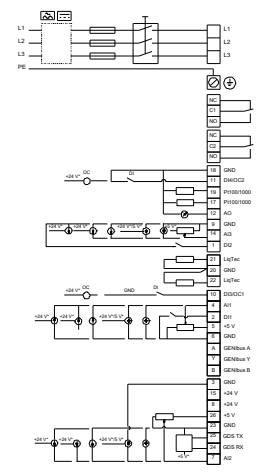
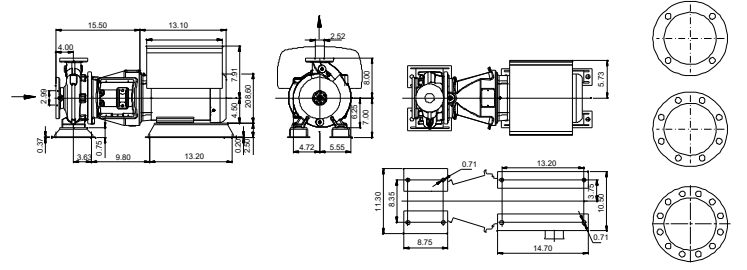
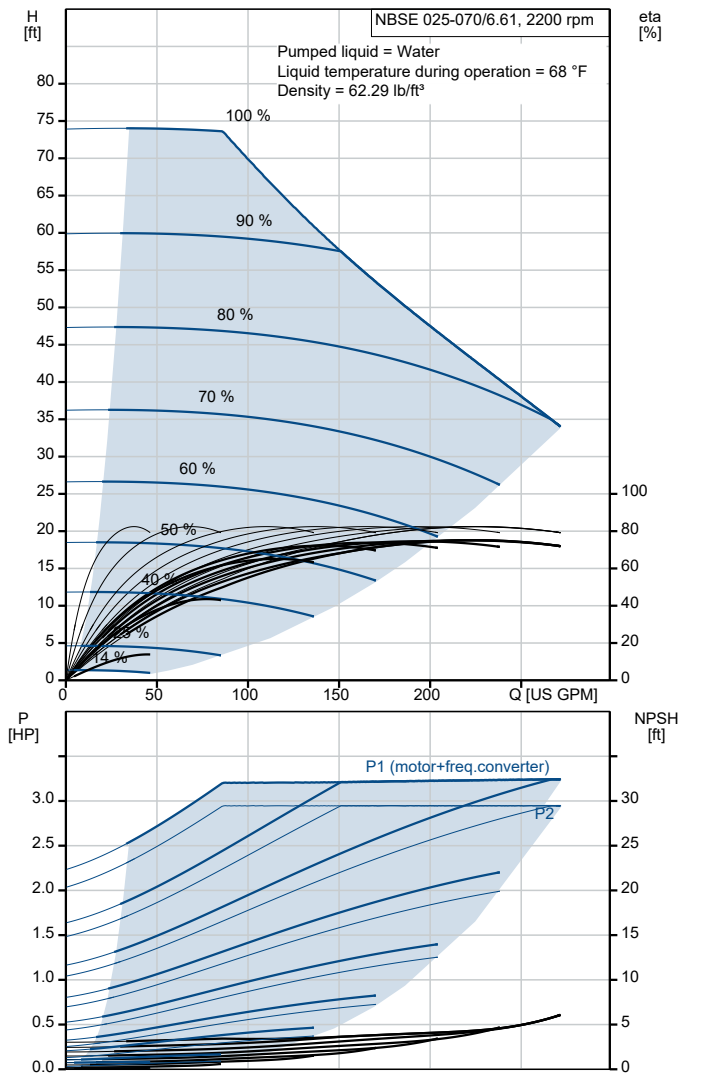

92613454 NBSE 025-070/6.61 ASASG6S2ESBQQEICA 60 Hz

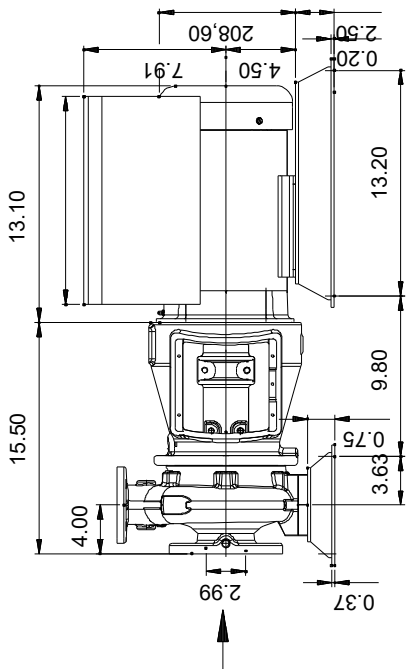
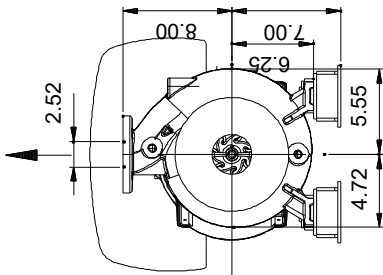
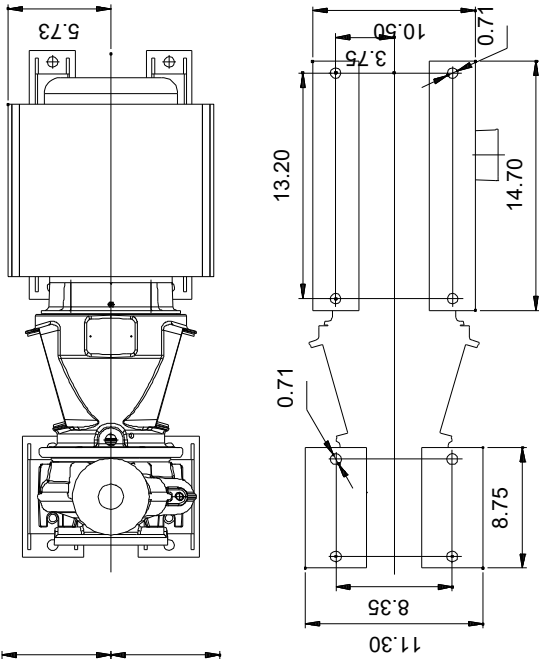
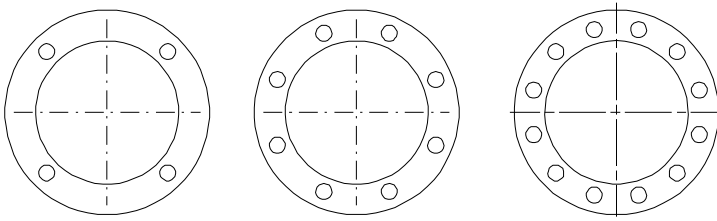

Note! All units are in [in] unless others are stated
 Disclaimer: This simplified dimensional drawing does not show all details.

92613454 NBSE 025-070/6.61 ASASG6S2ESBQQEICA 60 Hz



Note! All units are in [in] unless others are stated.