

Count	Description
1	<p data-bbox="225 338 435 360">MAGNA3 65-150 F</p>  <p data-bbox="225 658 488 680">Product No.: 98126852</p> <p data-bbox="225 748 1442 822">The Grundfos MAGNA3 circulator pump is the ideal choice for almost any building project – old or new. With its unrivalled energy efficiency, all-encompassing range and built-in communication capabilities, MAGNA3 is ideal for engineers and specifiers looking to create high-performance heating and cooling systems.</p> <p data-bbox="225 835 1449 909">The pump is maintenance-free due to the canned-rotor type design. This also means that pump and motor form an integral unit without shaft seal and with only two gaskets for sealing. The bearings are lubricated by the pumped liquid.</p> <p data-bbox="225 922 1406 969">MAGNA3 features an intuitive display and allows you to connect wirelessly with the Grundfos GO Remote app, giving you access to advanced reporting and monitoring.</p> <p data-bbox="225 983 1442 1030">The pump includes fieldbus communication via CIM modules as well as analog and digital inputs and configurable relays.</p> <p data-bbox="225 1043 1401 1090">Control features include AUTOADAPT and FLOWADAPT. FLOWADAPT which reduces the need for throttling valves, thus cutting costs on system components.</p> <p data-bbox="225 1104 1235 1126">MAGNA3 is the superior choice for a wide range of heating and cooling applications, including:</p> <ul data-bbox="225 1155 619 1301" style="list-style-type: none">• Mixing loops• Heating surfaces• Air conditioning surfaces• Ground-source heat pump systems• Smaller chiller applications. <p data-bbox="225 1335 1426 1382">MAGNA3 is a single-phase pump and characterised by having the controller and control display integrated in the control box. The pump also has a built-in differential-pressure and temperature sensor.</p> <p data-bbox="225 1395 1426 1469">The pump housing is available in both cast-iron and stainless-steel versions. The composite rotor can is carbon-fibre reinforced, the bearing plate and rotor cladding are made of stainless steel and the stator housing is made of aluminium. The power electronics are air-cooled.</p> <p data-bbox="225 1482 1390 1556">MAGNA3 incorporates a 4-pole synchronous, permanent-magnet motor (PM motor). This motor type is characterised by higher efficiency than a conventional asynchronous squirrel-cage motor. The pump speed is controlled by an integrated frequency converter.</p>



Company name:

Created by:

Phone:

Date:

12/31/2021

98126852 MAGNA3 65-150 F 60 Hz

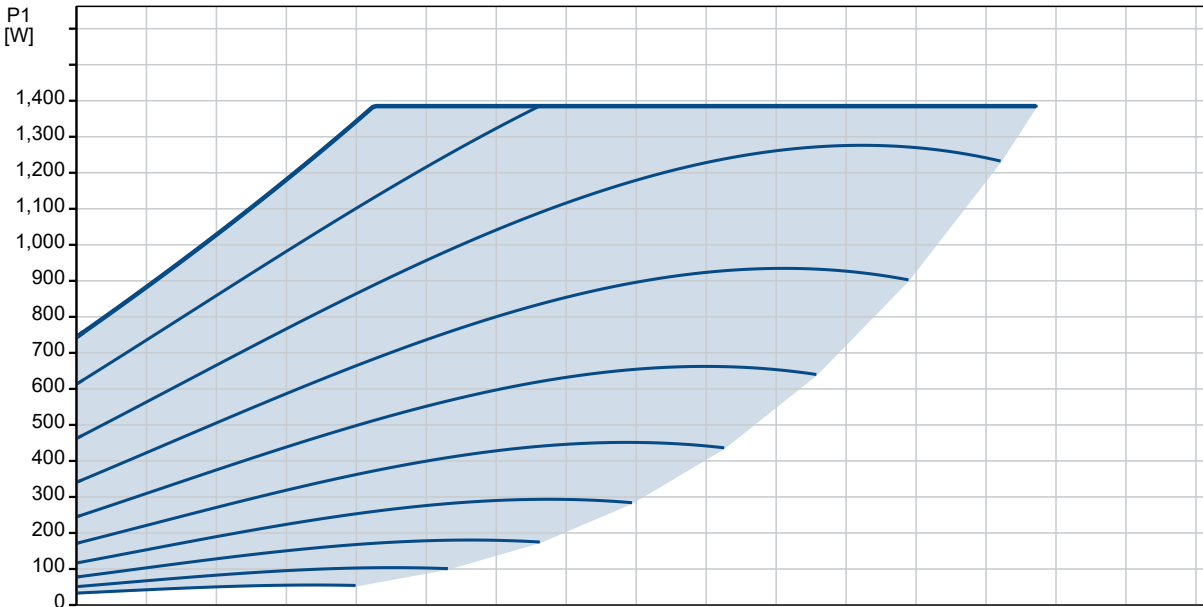
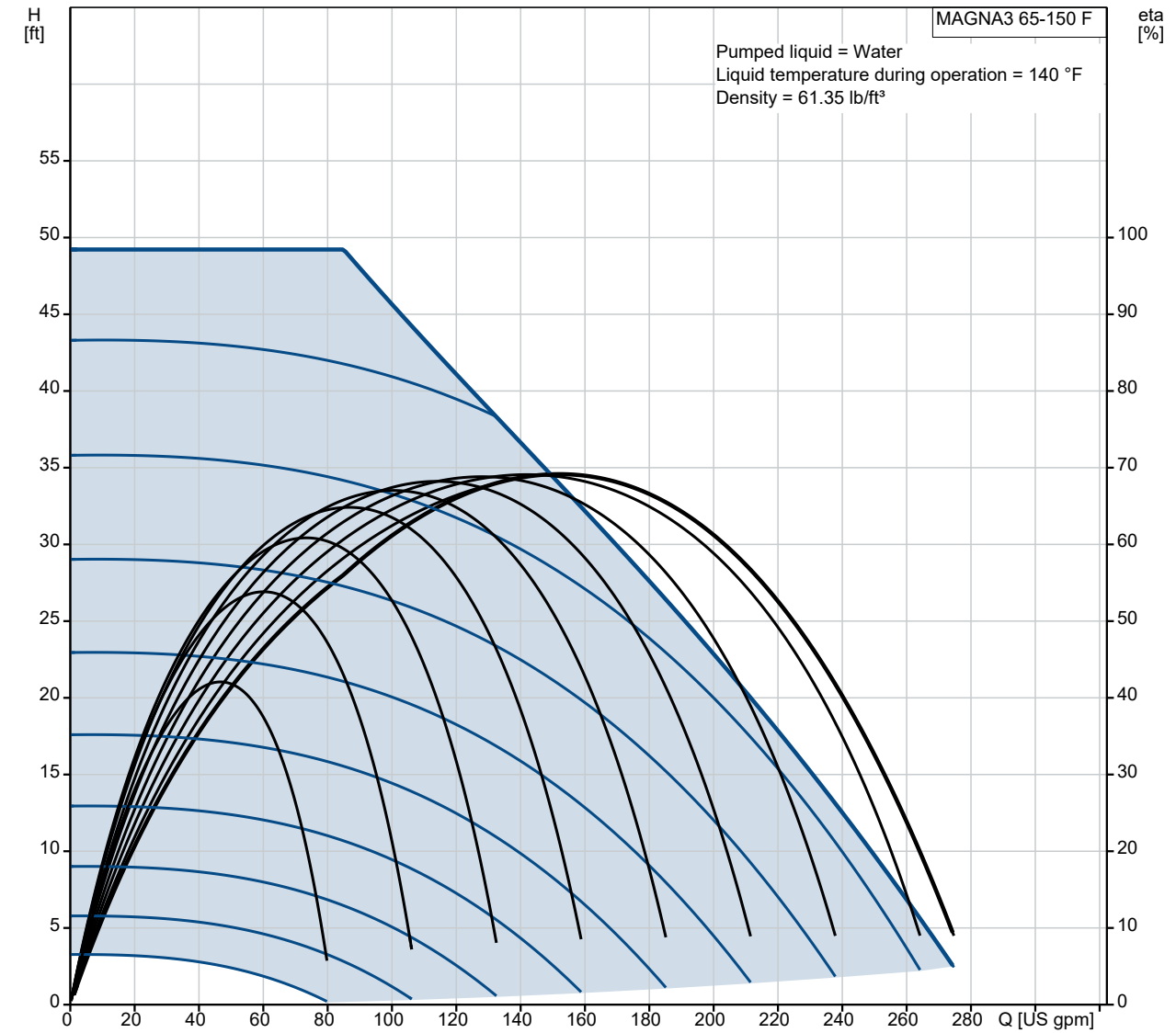

Description	Value
General information:	
Product name:	MAGNA3 65-150 F
Product No.:	98126852
EAN:	5710629500144
Technical:	
Rated flow:	125 US gpm
Rated head:	33.14 ft
Head max:	49.22 ft
TF class:	110
Approvals on nameplate:	98544605
Model:	D
Materials:	
Pump housing:	Cast iron
Pump housing:	EN-GJL-250
Pump housing:	ASTM A48-250B
Impeller:	PES 30%GF
Installation:	
Range of ambient temperature:	32 .. 104 °F
Maximum operating pressure:	174.05 psi
Flange standard:	GF
Pipe connection:	GF65
Pressure stage:	PN12
Port-to-port length:	13 7/16 in
Liquid:	
Pumped liquid:	Water
Liquid temperature range:	14 .. 230 °F
Selected liquid temperature:	140 °F
Density:	61.35 lb/ft³
Electrical data:	
Power input - P1:	29 .. 1385 W
Main frequency:	60 Hz
Rated voltage:	1 x 208-230 V
Maximum current consumption:	0.3 .. 6.1 A
Enclosure class (IEC 34-5):	X4D
Insulation class (IEC 85):	F
Others:	
Energy (EEI):	0.17
Net weight:	54.8 lb
Gross weight:	59.8 lb
Shipping volume:	1.94 ft³
Country of origin:	US
Custom tariff no.:	8413.70.2015

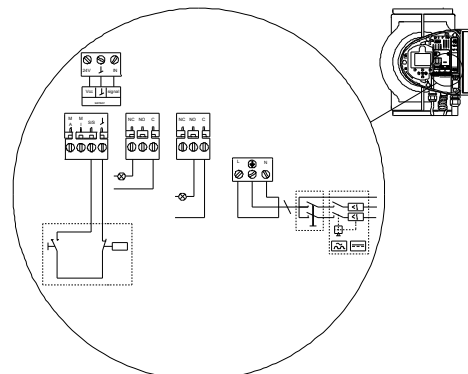
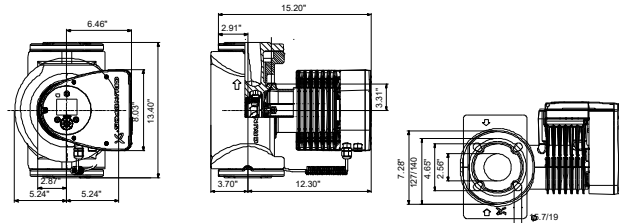
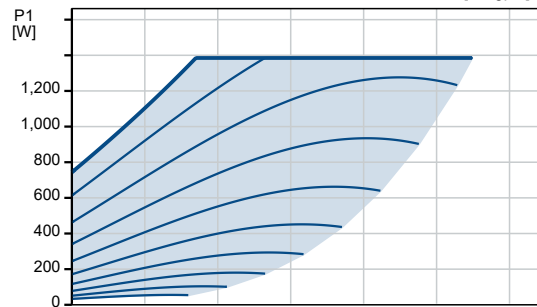
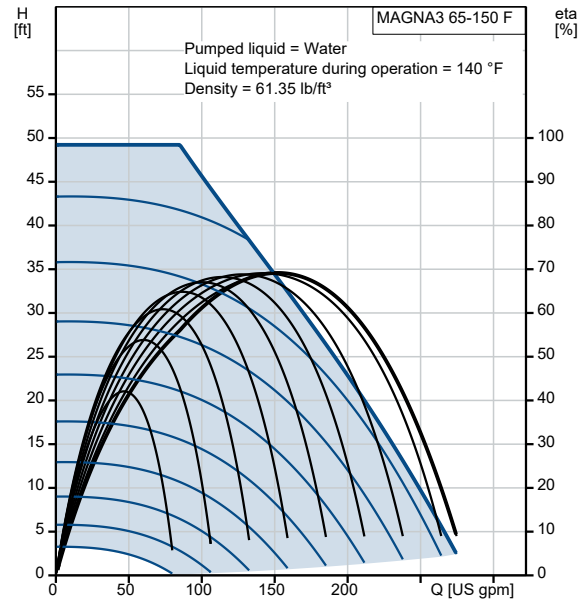

98126852 MAGNA3 65-150 F 60 Hz

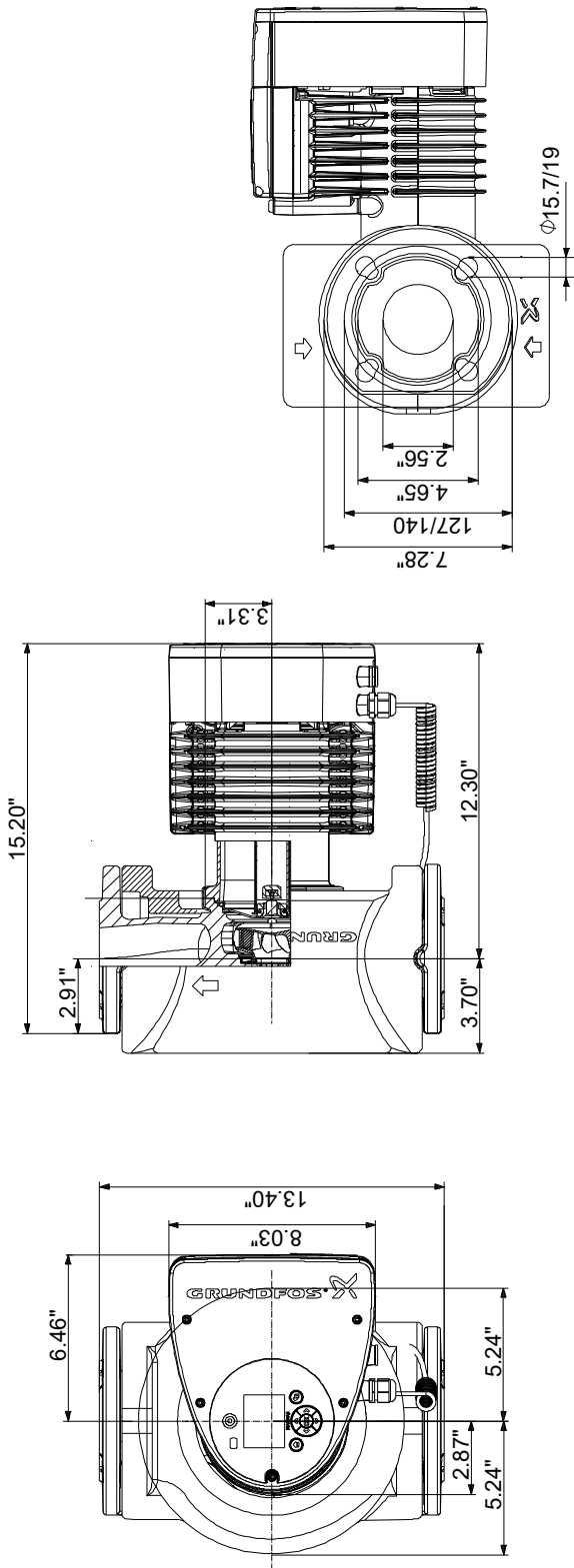

Note! All units are in [in] unless otherwise stated.
 Disclaimer: This simplified dimensional drawing does not show all details.

98126852 MAGNA3 65-150 F 60 Hz

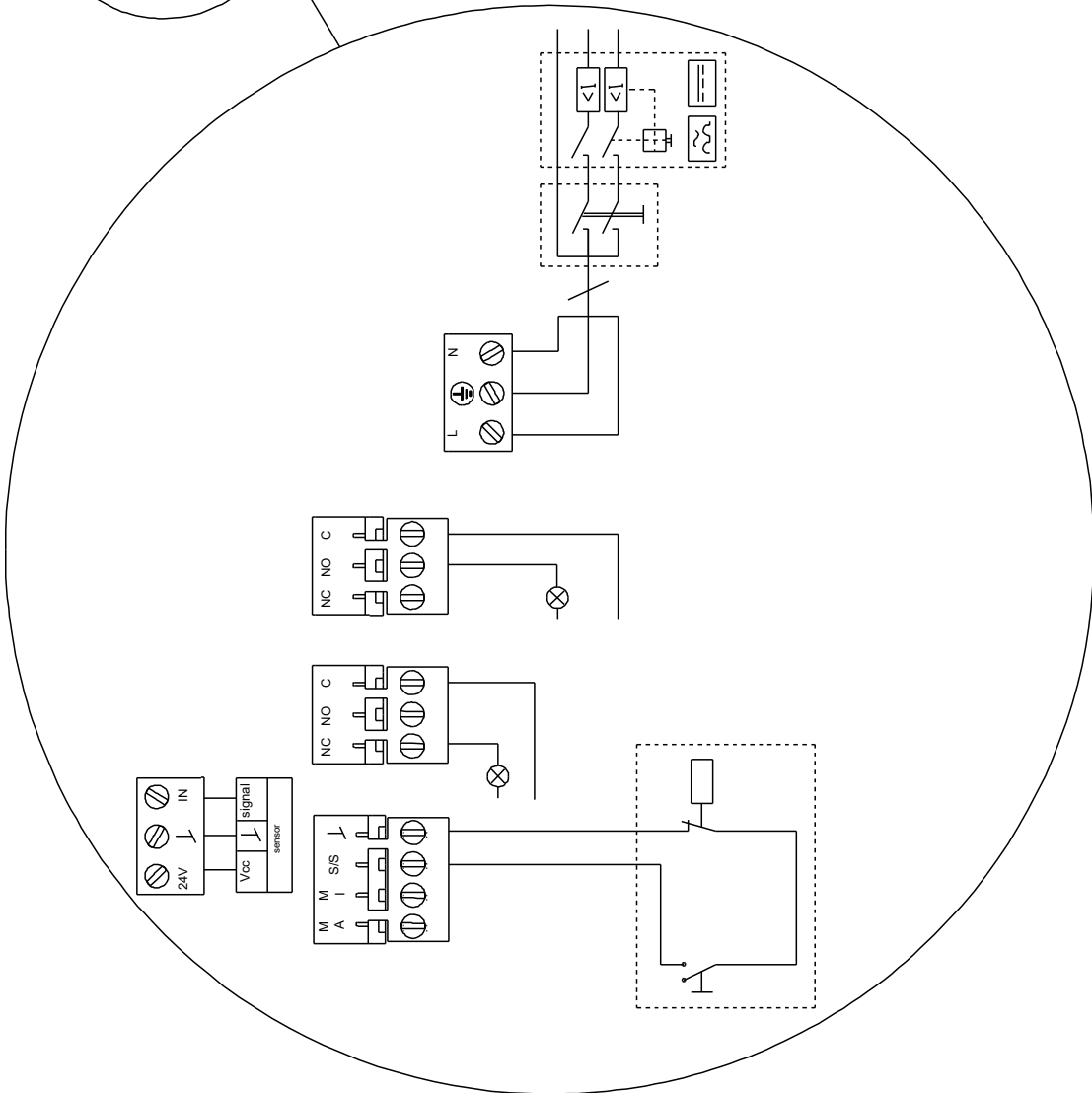
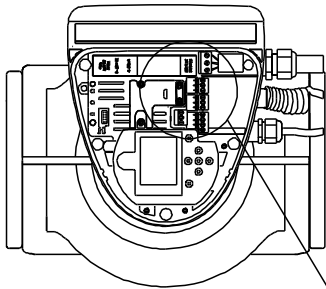

All units are [in] unless otherwise presented.