

Count	Description
1	<p data-bbox="225 338 459 360">MAGNA3 65-120 F N</p>  <p data-bbox="225 660 486 683">Product No.: 98124702</p> <p data-bbox="225 750 1444 817">The Grundfos MAGNA3 circulator pump is the ideal choice for almost any building project – old or new. With its unrivalled energy efficiency, all-encompassing range and built-in communication capabilities, MAGNA3 is ideal for engineers and specifiers looking to create high-performance heating and cooling systems.</p> <p data-bbox="225 840 1452 907">The pump is maintenance-free due to the canned-rotor type design. This also means that pump and motor form an integral unit without shaft seal and with only two gaskets for sealing. The bearings are lubricated by the pumped liquid.</p> <p data-bbox="225 918 1412 974">MAGNA3 features an intuitive display and allows you to connect wirelessly with the Grundfos GO Remote app, giving you access to advanced reporting and monitoring.</p> <p data-bbox="225 985 1444 1030">The pump includes fieldbus communication via CIM modules as well as analog and digital inputs and configurable relays.</p> <p data-bbox="225 1041 1396 1086">Control features include AUTOADAPT and FLOWADAPT. FLOWADAPT which reduces the need for throttling valves, thus cutting costs on system components.</p> <p data-bbox="225 1097 1236 1120">MAGNA3 is the superior choice for a wide range of heating and cooling applications, including:</p> <ul data-bbox="225 1153 614 1299" style="list-style-type: none">• Mixing loops• Heating surfaces• Air conditioning surfaces• Ground-source heat pump systems• Smaller chiller applications. <p data-bbox="225 1332 1428 1377">MAGNA3 is a single-phase pump and characterised by having the controller and control display integrated in the control box. The pump also has a built-in differential-pressure and temperature sensor.</p> <p data-bbox="225 1388 1428 1467">The pump housing is available in both cast-iron and stainless-steel versions. The composite rotor can is carbon-fibre reinforced, the bearing plate and rotor cladding are made of stainless steel and the stator housing is made of aluminium. The power electronics are air-cooled.</p> <p data-bbox="225 1478 1396 1545">MAGNA3 incorporates a 4-pole synchronous, permanent-magnet motor (PM motor). This motor type is characterised by higher efficiency than a conventional asynchronous squirrel-cage motor. The pump speed is controlled by an integrated frequency converter.</p>



Company name:

Created by:

Phone:

Date:

12/31/2021

98124702 MAGNA3 65-120 F N 60 Hz

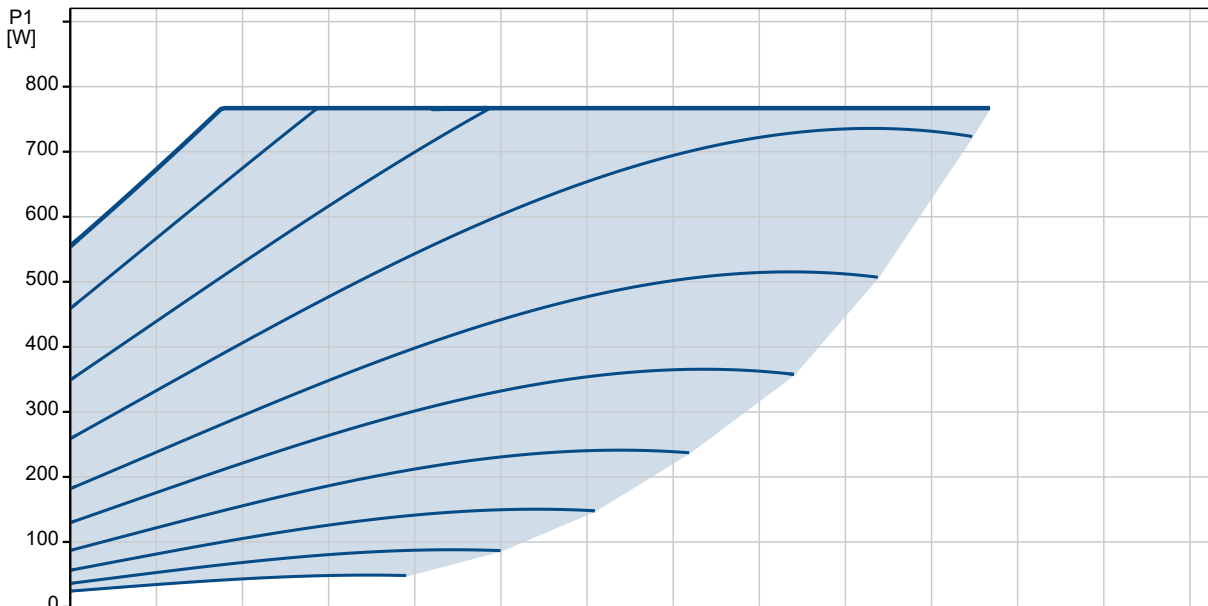
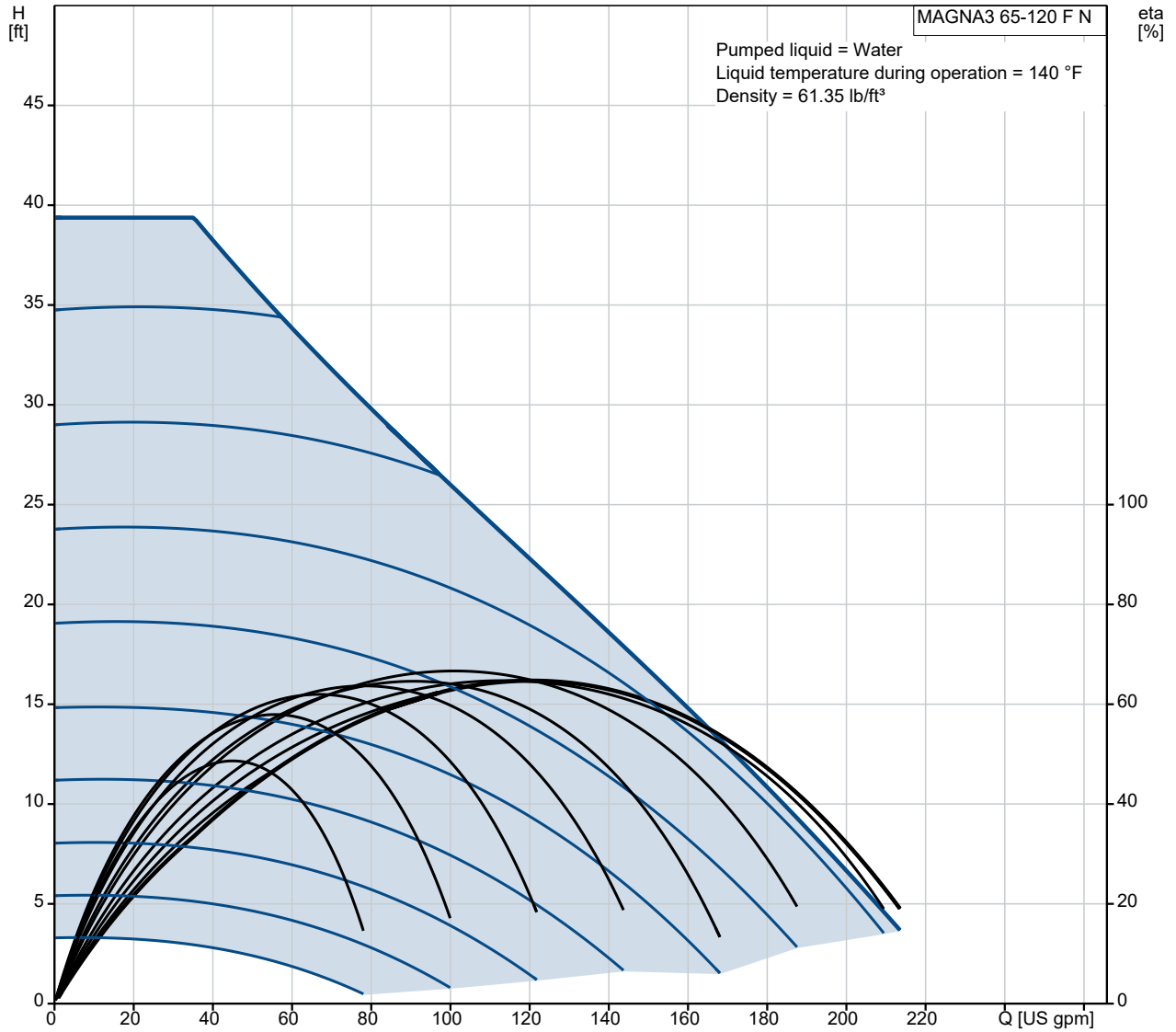

Description	Value
General information:	
Product name:	MAGNA3 65-120 F N
Product No.:	98124702
EAN:	5710629449542
Technical:	
Rated flow:	105 US gpm
Rated head:	23.3 ft
Head max:	39.37 ft
TF class:	110
Approvals on nameplate:	98544604
Model:	D
Materials:	
Pump housing:	Stainless steel
Pump housing:	EN 1.4308
Pump housing:	ASTM 351 CF8
Impeller:	PES 30%GF
Installation:	
Range of ambient temperature:	32 .. 104 °F
Maximum operating pressure:	174.05 psi
Flange standard:	GF
Pipe connection:	GF53/65
Pressure stage:	PN12
Port-to-port length:	13 7/16 in
Liquid:	
Pumped liquid:	Water
Liquid temperature range:	14 .. 230 °F
Selected liquid temperature:	140 °F
Density:	61.35 lb/ft³
Electrical data:	
Power input - P1:	20.5 .. 767 W
Main frequency:	60 Hz
Rated voltage:	1 x 115 V
Maximum current consumption:	0.36 .. 6.75 A
Enclosure class (IEC 34-5):	X4D
Insulation class (IEC 85):	F
Others:	
Energy (EEI):	0.17
Net weight:	52.2 lb
Gross weight:	57.2 lb
Shipping volume:	1.94 ft³
Country of origin:	US
Custom tariff no.:	8413.70.2015

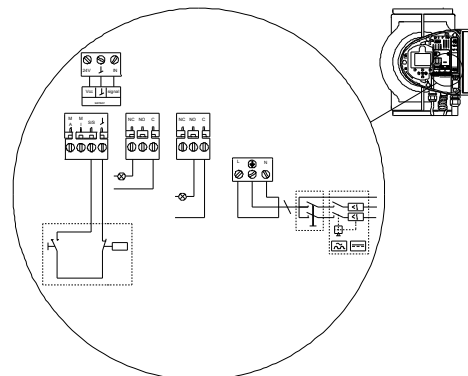
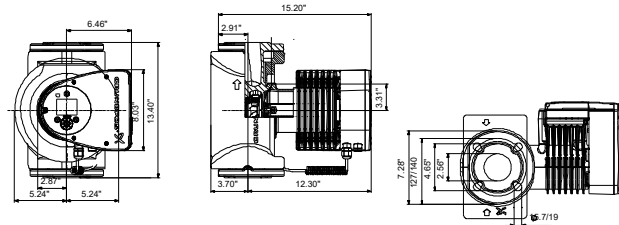
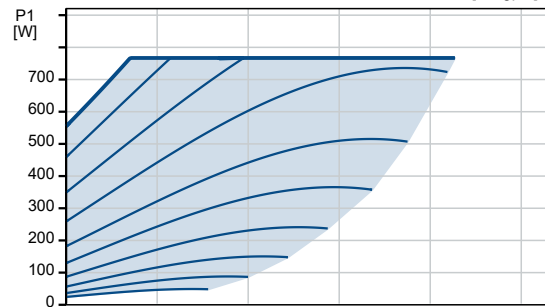
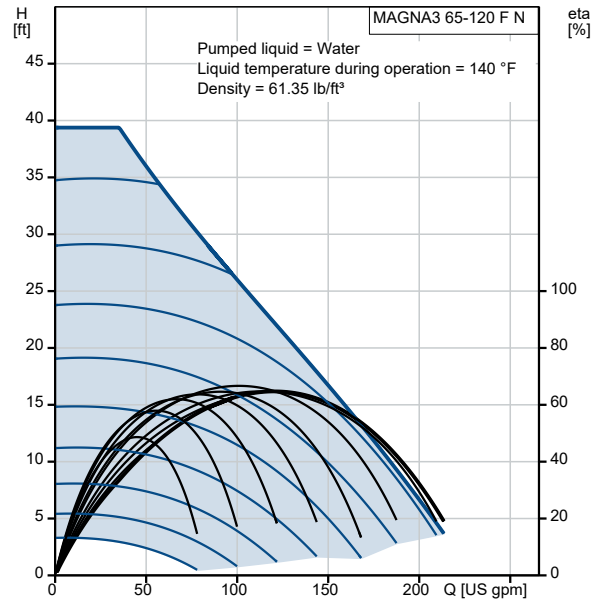

98124702 MAGNA3 65-120 F N 60 Hz

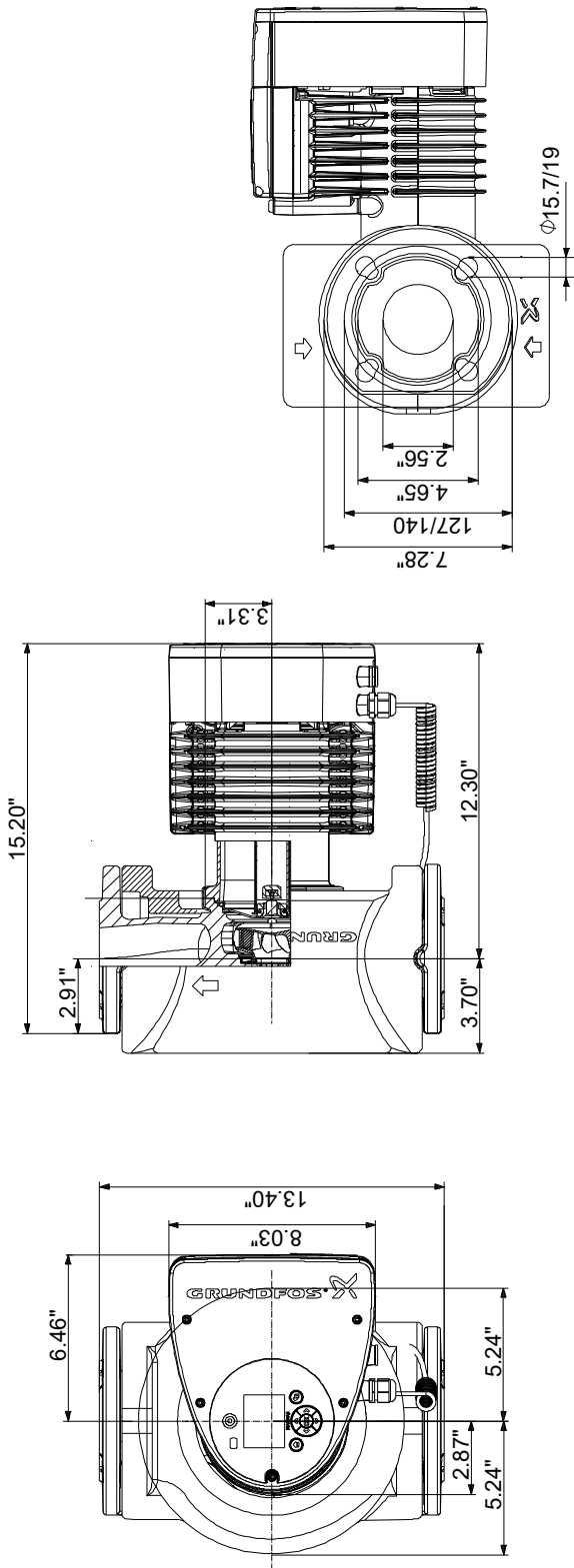

Note! All units are in [in] unless otherwise stated.
 Disclaimer: This simplified dimensional drawing does not show all details.