

PROJECT: _____	UNIT TAG: _____	QUANTITY: _____
REPRESENTATIVE: _____	TYPE OF SERVICE: _____	DATE: _____
ENGINEER: _____	SUBMITTED BY: _____	DATE: _____
CONTRACTOR: _____	APPROVED BY: _____	DATE: _____
	ORDER NO.: _____	DATE: _____



CRNE 3-6 BN-FGJ-A-E-HQQE

Vertical, multistage centrifugal pump with integrated frequency converter. Pump materials in contact with the liquid are in high-grade stainless steel (EN 1.4401)

Note! Product picture may differ from actual product

Conditions of Service		Pump Data		Motor Data	
Liquid:	Water	Max pressure at stated temp:	363 psi / 250 °F	Rated power - P2:	1.5 HP
Temperature:	68 °F	Liquid temperature range:	-4 .. 248 °F	Rated voltage:	200-240 V
Specific Gravity:	1.000	Maximum ambient temperature:	104 °F	Mains frequency:	60 Hz
		Shaft seal:	HQQE	Enclosure class:	IP55
		Product number:	99392537	Insulation class:	F
				Motor protection:	ELEC
				Motor type:	80B
				Eta 1/1:	89.3 %

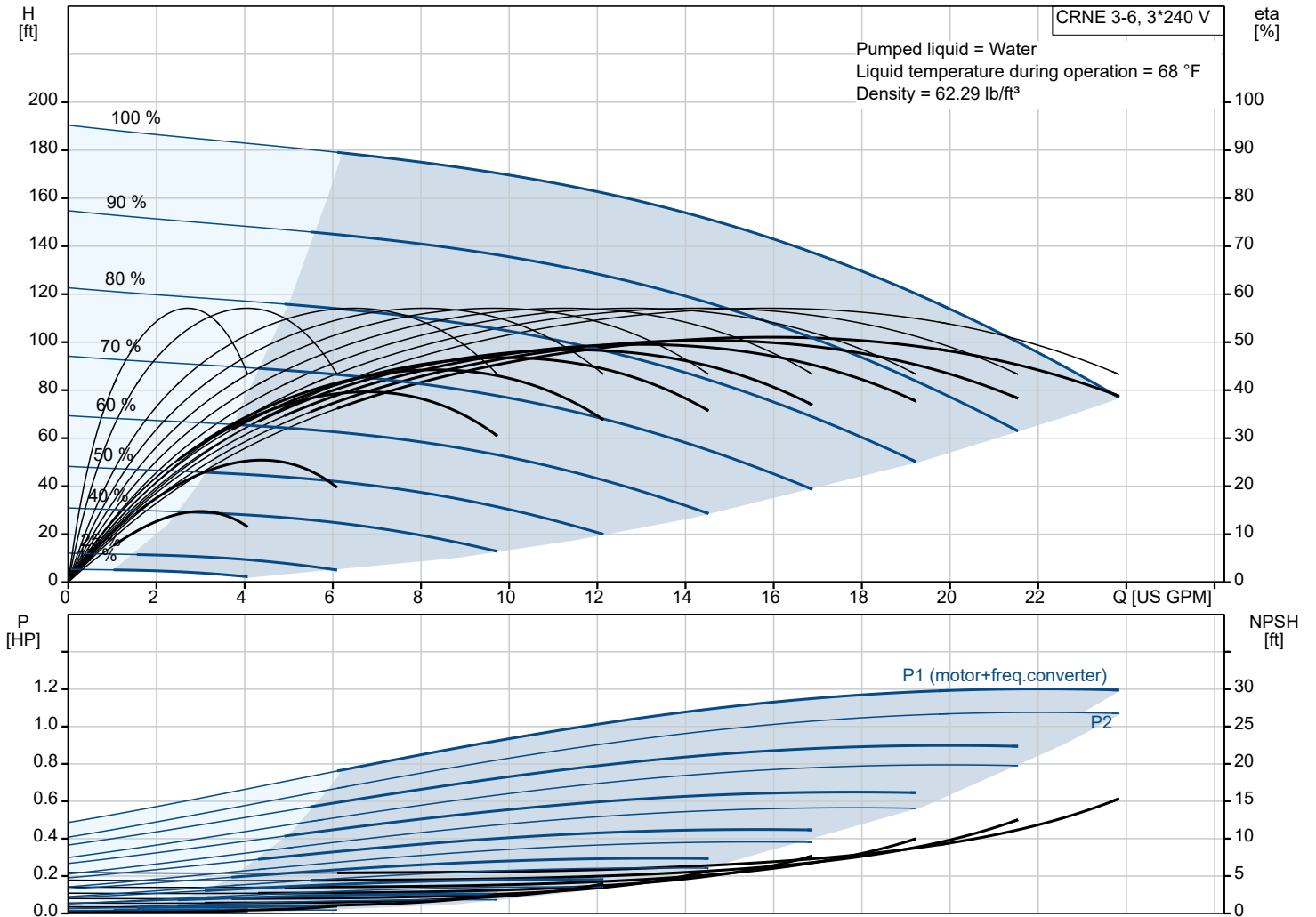

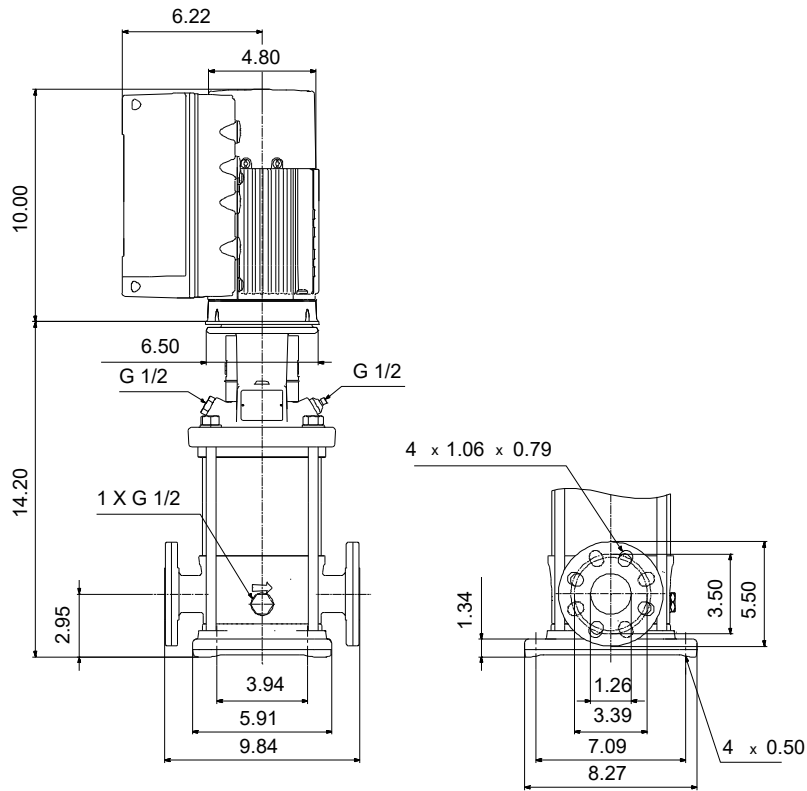

Materials:

- Base: Stainless steel
- Base: EN 1.4408
- Base: AISI 316
- Impeller: Stainless steel
- Impeller: AISI 316
- Impeller: EN 1.4401
- Material code: A
- Code for rubber: E

Qty.	Description
1	<p data-bbox="124 85 464 118">CRNE 3-6 BN-FGJ-A-E-HQQE</p> <p data-bbox="124 118 389 141">Product No.: 99392537</p> <p data-bbox="124 174 1520 253">Vertical, multistage centrifugal pump with inlet and outlet ports on same the level (inline). Pump materials in contact with the liquid are in high-grade stainless steel. A cartridge shaft seal ensures high reliability, safe handling, and easy access and service. Power transmission is via a rigid split coupling. Pipe connection is via combined DIN-ANSI-JIS flanges.</p> <p data-bbox="124 264 1051 297">The pump is fitted with a 3-phase, fan-cooled, permanent-magnet, synchronous motor.</p> <p data-bbox="124 297 940 320">The motor efficiency is classified as IE5 in accordance with IEC 60034-30-2.</p> <p data-bbox="124 320 1520 376">The motor includes a frequency converter and PI controller in the motor terminal box. This enables continuously variable control of the motor speed, which again enables adaptation of the performance to a given requirement.</p> <p data-bbox="124 376 1469 409">The operating panel on the motor terminal box features a four-inch TFT display, push-buttons and the Grundfos Eye indicator.</p> <p data-bbox="124 443 890 465">The display gives an intuitive and user-friendly interface to all functions.</p> <p data-bbox="124 465 1461 521">The push-buttons are used to navigate through the menu structure to access pump and performance data on site and enable setting of required setpoint as well as setting of pump to "Min." or "Max." operation or to "Stop".</p> <p data-bbox="124 589 1520 667">Communication with the pump is also possible by means of Grundfos GO Remote (accessory). The remote control enables further settings as well as reading out of a number of parameters such as "Actual value", "Speed", "Power input" and total "Power consumption".</p> <p data-bbox="124 701 1114 734">The Grundfos Eye indicator on the operating panel provides visual indication of pump status:</p> <ul data-bbox="164 734 1433 824" style="list-style-type: none"> • "Power on": Motor is running (rotating green indicator lights) or not running (permanently green indicator lights) • "Warning": Motor is still running (rotating yellow indicator lights) or has stopped (permanently yellow indicator lights) • "Alarm": Motor has stopped (flashing red indicator lights). <p data-bbox="124 824 1501 880">The terminal box has a number of inputs and outputs enabling the motor to be used in advanced applications where many inputs and outputs are required:</p> <ul data-bbox="164 880 1501 1261" style="list-style-type: none"> • two dedicated digital inputs • three analog inputs, 0(4)-20 mA, 0-5 V, 0-10 V, 0.5 - 3.5 V; the factory-fitted pressure sensor is connected to one of these inputs • 5 V voltage supply to potentiometer and sensor • one analog output, 0-10 V, 0(4)-20 mA • two configurable digital inputs or open-collector outputs • two Pt100/Pt1000 inputs • LiqTec, dry-running protection sensor input • Grundfos Digital Sensor input and output • 24 V voltage supply for sensors • two signal-relay outputs (potential-free contacts) • GENIbus connection • interface for Grundfos CIM fieldbus module. <p data-bbox="124 1294 199 1317">Liquid:</p> <p data-bbox="124 1328 555 1350">Pumped liquid: Water</p> <p data-bbox="124 1361 611 1384">Liquid temperature range: -4 .. 248 °F</p> <p data-bbox="124 1395 547 1417">Selected liquid temperature: 68 °F</p> <p data-bbox="124 1429 611 1451">Density: 62.29 lb/ft³</p> <p data-bbox="124 1485 236 1507">Technical:</p> <p data-bbox="124 1518 746 1541">Pump speed on which pump data are based: 3484 rpm</p> <p data-bbox="124 1552 643 1574">Rated flow: 15.4 US GPM</p> <p data-bbox="124 1585 579 1608">Rated head: 137.5 ft</p> <p data-bbox="124 1619 579 1641">Pump orientation: Vertical</p> <p data-bbox="124 1653 563 1675">Shaft seal arrangement: Single</p> <p data-bbox="124 1686 563 1709">Code for shaft seal: HQQE</p> <p data-bbox="124 1720 579 1742">Approvals: CURUS</p> <p data-bbox="124 1753 643 1776">Approvals for drinking water: NSF/ANSI 61</p> <p data-bbox="124 1787 691 1809">Curve tolerance: ISO9906:2012 3B</p> <p data-bbox="124 1843 236 1865">Materials:</p> <p data-bbox="124 1877 643 1921">Base: Stainless steel EN 1.4408 AISI 316</p> <p data-bbox="124 1933 643 2011">Impeller: Stainless steel EN 1.4401 AISI 316</p> <p data-bbox="124 2022 531 2045">Bearing: SIC</p> <p data-bbox="124 2078 252 2101">Installation:</p> <p data-bbox="124 2112 563 2134">t max amb: 104 °F</p> <p data-bbox="124 2145 611 2168">Maximum operating pressure: 362.59 psi</p> <p data-bbox="124 2179 659 2201">Max pressure at stated temp: 363 psi / 250 °F</p>

Qty.	Description
	<p>363 psi / -4 °F</p> <p>Type of connection: DIN / ANSI / JIS</p> <p>Size of inlet connection: DN 25/32</p> <p>Size of outlet connection: DN 25/32</p> <p>Pressure rating for connection: PN 25</p> <p>Flange rating inlet: 300 lb</p> <p>Flange size for motor: 56C</p> <p>Electrical data:</p> <p>Motor standard: NEMA</p> <p>Motor type: 80B</p> <p>IE Efficiency class: IE5</p> <p>Rated power - P2: 1.5 HP</p> <p>Power (P2) required by pump: 1.5 HP</p> <p>Mains frequency: 60 Hz</p> <p>Rated voltage: 3 x 200-240 V</p> <p>Service factor: 1.15</p> <p>Rated current: 4.10-3.50 A</p> <p>Cos phi - power factor: 0.91</p> <p>Rated speed: 360-4000 rpm</p> <p>Efficiency: 89.3%</p> <p>Motor efficiency at full load: 89.3 %</p> <p>Enclosure class (IEC 34-5): IP55</p> <p>Insulation class (IEC 85): F</p> <p>Motor No: 99301705</p> <p>Controls:</p> <p>Frequency converter: Built-in</p> <p>Pressure sensor: Y</p> <p>Others:</p> <p>Net weight: 65.3 lb</p> <p>Gross weight: 149 lb</p> <p>Shipping volume: 4.94 ft³</p>

99392537 CRNE 3-6 BN-FGJ-A-E-HQQE 60 Hz



Note! All units are in [in] unless others are stated.