

PROJECT: _____	UNIT TAG: _____	QUANTITY: _____
REPRESENTATIVE: _____	TYPE OF SERVICE: _____	DATE: _____
ENGINEER: _____	SUBMITTED BY: _____	DATE: _____
CONTRACTOR: _____	APPROVED BY: _____	DATE: _____
	ORDER NO.: _____	DATE: _____



CRNE 15-6 N-FGJ-A-E-HQQE

Vertical, multistage centrifugal pump with integrated frequency converter. Pump materials in contact with the liquid are in high-grade stainless steel (EN 1.4401)

Note! Product picture may differ from actual product

Conditions of Service		Pump Data		Motor Data	
Liquid:	Water	Max pressure at stated temp:	363 psi / 250 °F	Rated power - P2:	15 HP
Temperature:	68 °F	Liquid temperature range:	-4 .. 248 °F	Rated voltage:	440-480 V
Specific Gravity:	1.000	Maximum ambient temperature:	122 °F	Mains frequency:	60 Hz
		Shaft seal:	HQQE	Enclosure class:	IP55
		Product number:	99076414	Insulation class:	F
				Motor protection:	ELEC
				Motor type:	160H
				Eta 1/1:	93.2 %

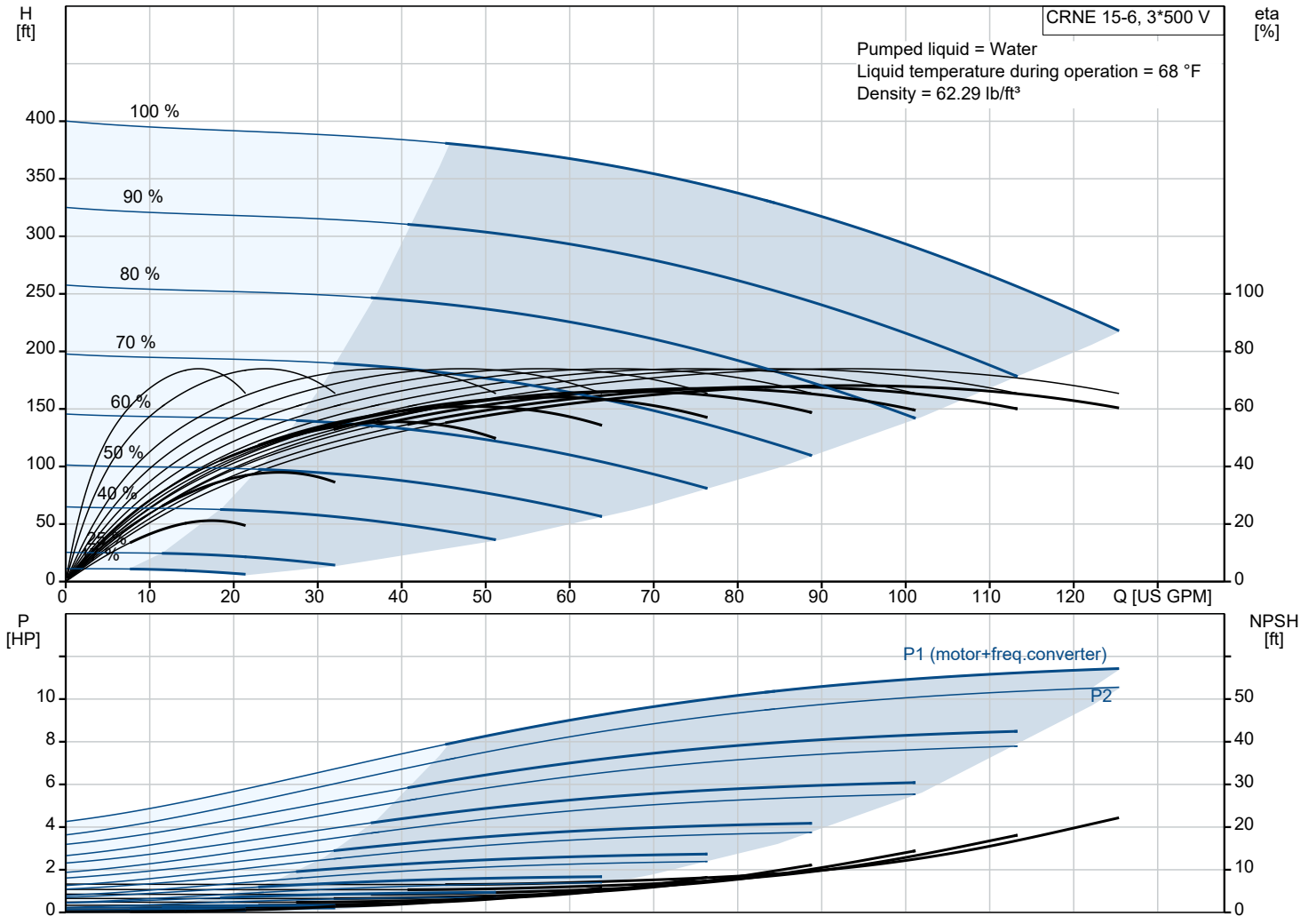

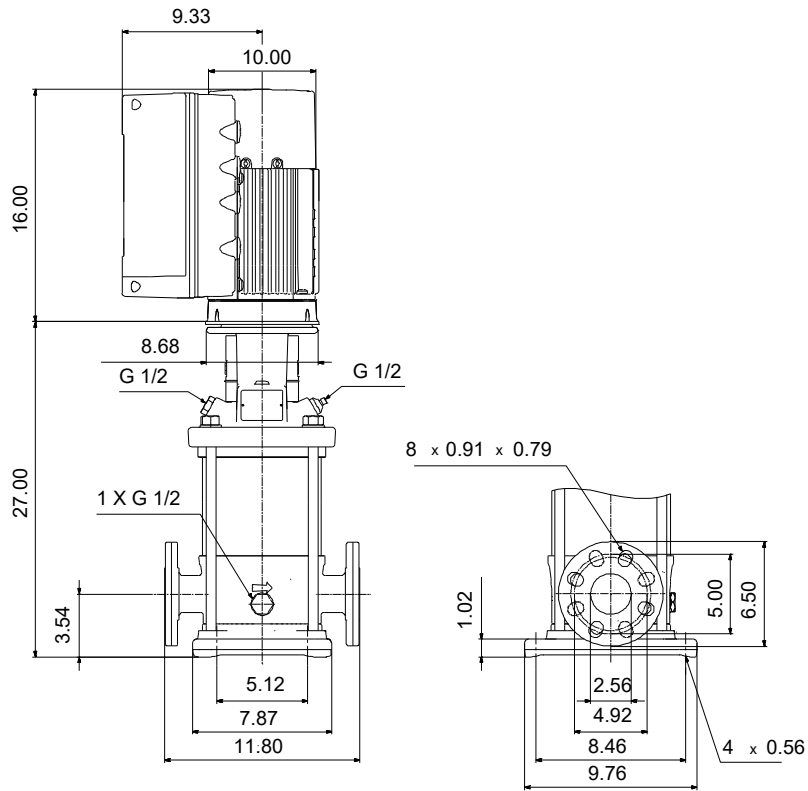

Materials:

- Base: Stainless steel
- Base: EN 1.4408
- Base: AISI 316
- Impeller: Stainless steel
- Impeller: AISI 316
- Impeller: EN 1.4401
- Material code: A
- Code for rubber: E

Qty.	Description
1	<p data-bbox="124 85 459 118">CRNE 15-6 N-FGJ-A-E-HQQE</p> <p data-bbox="124 118 391 141">Product No.: 99076414</p> <p data-bbox="124 174 1520 253">Vertical, multistage centrifugal pump with inlet and outlet ports on same the level (inline). Pump materials in contact with the liquid are in high-grade stainless steel. A cartridge shaft seal ensures high reliability, safe handling, and easy access and service. Power transmission is via a rigid split coupling. Pipe connection is via combined DIN-ANSI-JIS flanges.</p> <p data-bbox="124 264 1050 297">The pump is fitted with a 3-phase, fan-cooled, permanent-magnet, synchronous motor.</p> <p data-bbox="124 297 938 320">The motor efficiency is classified as IE5 in accordance with IEC 60034-30-2.</p> <p data-bbox="124 320 1520 376">The motor includes a frequency converter and PI controller in the motor terminal box. This enables continuously variable control of the motor speed, which again enables adaptation of the performance to a given requirement.</p> <p data-bbox="124 376 1473 409">The operating panel on the motor terminal box features a four-inch TFT display, push-buttons and the Grundfos Eye indicator.</p> <p data-bbox="124 443 890 465">The display gives an intuitive and user-friendly interface to all functions.</p> <p data-bbox="124 465 1465 521">The push-buttons are used to navigate through the menu structure to access pump and performance data on site and enable setting of required setpoint as well as setting of pump to "Min." or "Max." operation or to "Stop".</p> <p data-bbox="124 589 1520 667">Communication with the pump is also possible by means of Grundfos GO Remote (accessory). The remote control enables further settings as well as reading out of a number of parameters such as "Actual value", "Speed", "Power input" and total "Power consumption".</p> <p data-bbox="124 701 1114 723">The Grundfos Eye indicator on the operating panel provides visual indication of pump status:</p> <ul data-bbox="164 723 1436 824" style="list-style-type: none"> • "Power on": Motor is running (rotating green indicator lights) or not running (permanently green indicator lights) • "Warning": Motor is still running (rotating yellow indicator lights) or has stopped (permanently yellow indicator lights) • "Alarm": Motor has stopped (flashing red indicator lights). <p data-bbox="124 824 1505 880">The terminal box has a number of inputs and outputs enabling the motor to be used in advanced applications where many inputs and outputs are required:</p> <ul data-bbox="164 880 1505 1261" style="list-style-type: none"> • two dedicated digital inputs • three analog inputs, 0(4)-20 mA, 0-5 V, 0-10 V, 0.5 - 3.5 V; the factory-fitted pressure sensor is connected to one of these inputs • 5 V voltage supply to potentiometer and sensor • one analog output, 0-10 V, 0(4)-20 mA • two configurable digital inputs or open-collector outputs • two Pt100/Pt1000 inputs • LiqTec, dry-running protection sensor input • Grundfos Digital Sensor input and output • 24 V voltage supply for sensors • two signal-relay outputs (potential-free contacts) • GENIbus connection • interface for Grundfos CIM fieldbus module. <p data-bbox="124 1294 199 1317">Liquid:</p> <p data-bbox="124 1328 555 1350">Pumped liquid: Water</p> <p data-bbox="124 1350 611 1373">Liquid temperature range: -4 .. 248 °F</p> <p data-bbox="124 1373 547 1395">Selected liquid temperature: 68 °F</p> <p data-bbox="124 1395 611 1417">Density: 62.29 lb/ft³</p> <p data-bbox="124 1473 236 1496">Technical:</p> <p data-bbox="124 1507 746 1529">Pump speed on which pump data are based: 3470 rpm</p> <p data-bbox="124 1529 643 1552">Rated flow: 90.3 US GPM</p> <p data-bbox="124 1552 579 1574">Rated head: 300.9 ft</p> <p data-bbox="124 1574 563 1597">Actual impeller diameter: 4.13 in</p> <p data-bbox="124 1597 571 1619">Pump orientation: Vertical</p> <p data-bbox="124 1619 547 1641">Shaft seal arrangement: Single</p> <p data-bbox="124 1641 563 1664">Code for shaft seal: HQQE</p> <p data-bbox="124 1664 579 1686">Approvals: CURUS</p> <p data-bbox="124 1686 635 1709">Approvals for drinking water: NSF/ANSI 61</p> <p data-bbox="124 1709 683 1731">Curve tolerance: ISO9906:2012 3B</p> <p data-bbox="124 1832 236 1854">Materials:</p> <p data-bbox="124 1865 651 1944">Base: Stainless steel EN 1.4408 AISI 316</p> <p data-bbox="124 1955 651 2033">Impeller: Stainless steel EN 1.4401 AISI 316</p> <p data-bbox="124 2045 531 2067">Bearing: SIC</p> <p data-bbox="124 2101 252 2123">Installation:</p> <p data-bbox="124 2134 563 2157">t max amb: 122 °F</p> <p data-bbox="124 2157 603 2179">Maximum operating pressure: 362.59 psi</p>

Qty.	Description
	Max pressure at stated temp: 363 psi / 250 °F 363 psi / -4 °F Type of connection: DIN / ANSI / JIS Size of inlet connection: DN 50 Size of outlet connection: DN 50 Pressure rating for connection: PN 25 Flange rating inlet: 300 lb Flange size for motor: 254TC Electrical data: Motor standard: NEMA Motor type: 160H IE Efficiency class: IE5 Rated power - P2: 15 HP Power (P2) required by pump: 15 HP Mains frequency: 60 Hz Rated voltage: 3 x 440-480 V Service factor: 1.15 Rated current: 17.9-16.6 A Cos phi - power factor: 0.92-0.91 Rated speed: 360-4000 rpm Efficiency: 93.2% Motor efficiency at full load: 93.2 % Enclosure class (IEC 34-5): IP55 Insulation class (IEC 85): F Motor No: 99256777 Controls: Frequency converter: Built-in Pressure sensor: Y Others: DOE Pump Energy Index VL: 0.40 Net weight: 227 lb Gross weight: 313 lb Shipping volume: 13.1 ft³

99076414 CRNE 15-6 N-FGJ-A-E-HQQE 60 Hz



Note! All units are in [in] unless others are stated.