

PROJECT: _____	UNIT TAG: _____	QUANTITY: _____
REPRESENTATIVE: _____	TYPE OF SERVICE: _____	DATE: _____
ENGINEER: _____	SUBMITTED BY: _____	DATE: _____
CONTRACTOR: _____	APPROVED BY: _____	DATE: _____
	ORDER NO.: _____	DATE: _____



CRE 10-8 N-GJ-A-E-HQQE

Vertical, multistage centrifugal pump with integrated frequency converter. The pump head and base are in cast iron - all other wetted parts are in stainless steel (EN 1.4301)

Note! Product picture may differ from actual product

Conditions of Service		Pump Data		Motor Data	
Liquid:	Water	Max pressure at stated temp:	232 psi / 250 °F	Rated power - P2:	7.5 HP
Temperature:	68 °F	Liquid temperature range:	-4 .. 248 °F	Rated voltage:	200-240 V
Specific Gravity:	1.000	Maximum ambient temperature:	104 °F	Mains frequency:	60 Hz
		Shaft seal:	HQQE	Enclosure class:	IP55
		Product number:	99392015	Insulation class:	F
				Motor protection:	ELEC
				Motor type:	132F
				Eta 1/1:	90.2 %

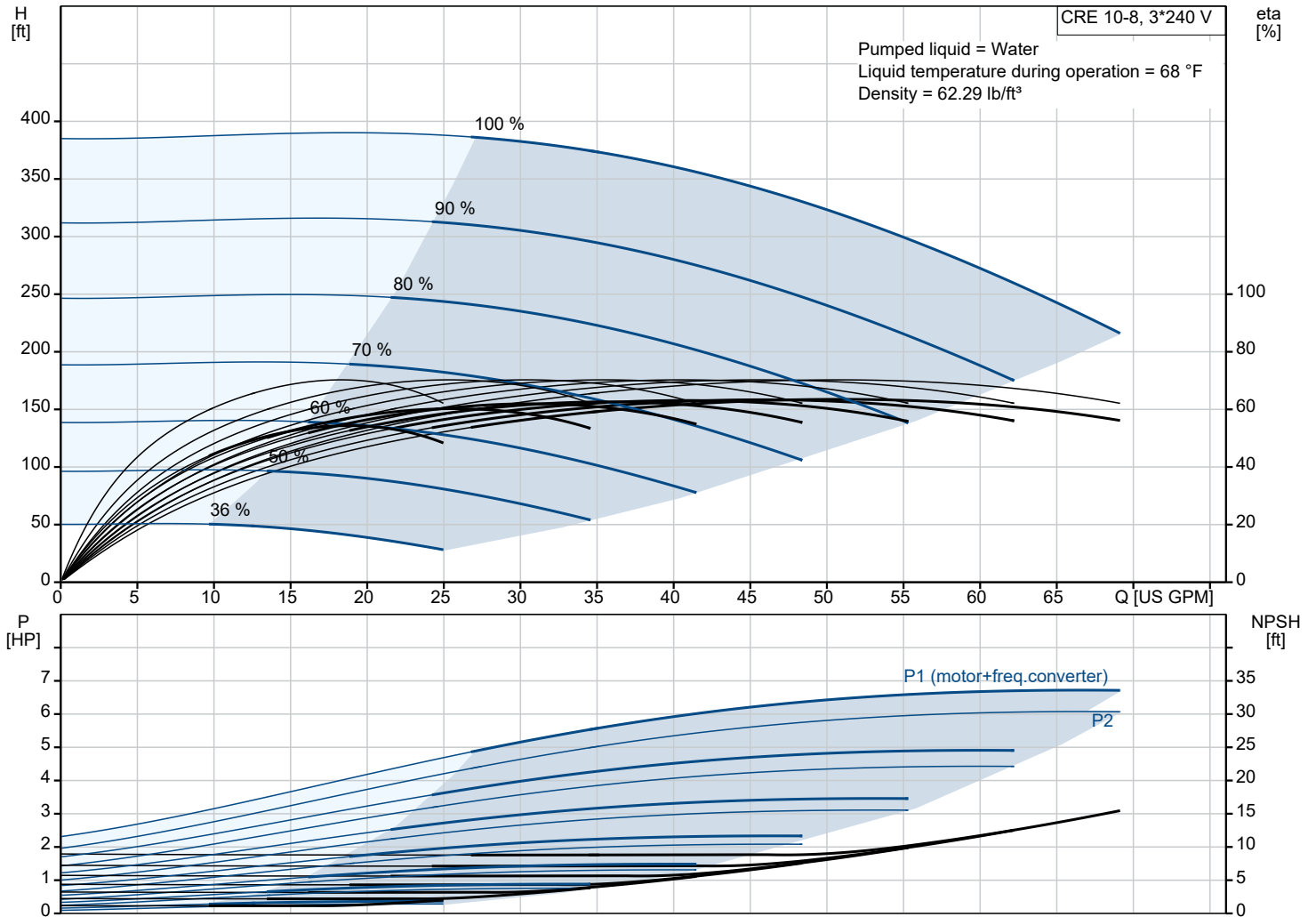

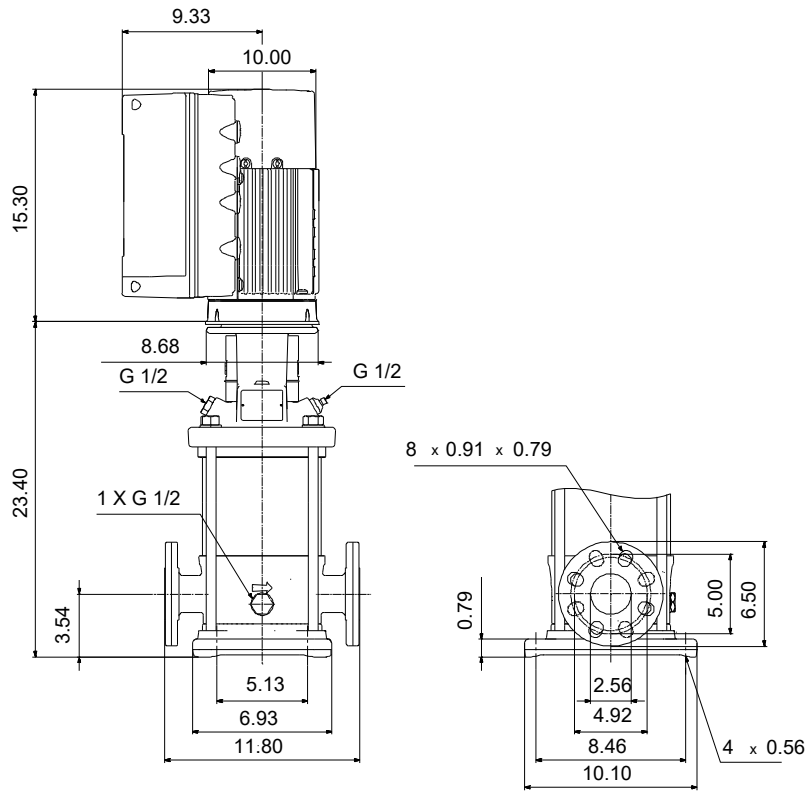

Materials:

Base: Cast iron
 Base: EN 1561 EN-GJL-200
 Base: ASTM A48-25B
 Impeller: Stainless steel
 Impeller: AISI 304
 Impeller: EN 1.4301
 Material code: A
 Code for rubber: E

Qty.	Description
1	<p data-bbox="124 85 427 114">CRE 10-8 N-GJ-A-E-HQQE</p>  <p data-bbox="517 434 989 459">Note! Product picture may differ from actual product</p> <p data-bbox="124 465 391 492">Product No.: 99392015</p> <p data-bbox="124 524 1522 600">Vertical, multistage centrifugal pump with inlet and outlet ports on same the level (inline). The pump head and base are in cast iron – all other wetted parts are in stainless steel. A cartridge shaft seal ensures high reliability, safe handling, and easy access and service. Power transmission is via a rigid split coupling. Pipe connection is via combined ANSI-JIS flanges.</p> <p data-bbox="124 611 1050 638">The pump is fitted with a 3-phase, fan-cooled, permanent-magnet, synchronous motor.</p> <p data-bbox="124 640 938 667">The motor efficiency is classified as IE5 in accordance with IEC 60034-30-2.</p> <p data-bbox="124 669 1522 719">The motor includes a frequency converter and PI controller in the motor terminal box. This enables continuously variable control of the motor speed, which again enables adaptation of the performance to a given requirement.</p> <p data-bbox="124 725 1469 752">The operating panel on the motor terminal box features a four-inch TFT display, push-buttons and the Grundfos Eye indicator.</p> <p data-bbox="124 786 890 813">The display gives an intuitive and user-friendly interface to all functions.</p> <p data-bbox="124 815 1461 864">The push-buttons are used to navigate through the menu structure to access pump and performance data on site and enable setting of required setpoint as well as setting of pump to "Min." or "Max." operation or to "Stop".</p> <p data-bbox="124 934 1522 1010">Communication with the pump is also possible by means of Grundfos GO Remote (accessory). The remote control enables further settings as well as reading out of a number of parameters such as "Actual value", "Speed", "Power input" and total "Power consumption".</p> <p data-bbox="124 1048 1114 1075">The Grundfos Eye indicator on the operating panel provides visual indication of pump status:</p> <ul data-bbox="164 1077 1433 1167" style="list-style-type: none"> • "Power on": Motor is running (rotating green indicator lights) or not running (permanently green indicator lights) • "Warning": Motor is still running (rotating yellow indicator lights) or has stopped (permanently yellow indicator lights) • "Alarm": Motor has stopped (flashing red indicator lights). <p data-bbox="124 1169 1501 1218">The terminal box has a number of inputs and outputs enabling the motor to be used in advanced applications where many inputs and outputs are required:</p> <ul data-bbox="164 1225 1501 1608" style="list-style-type: none"> • two dedicated digital inputs • three analog inputs, 0(4)-20 mA, 0-5 V, 0-10 V, 0.5 - 3.5 V; the factory-fitted pressure sensor is connected to one of these inputs • 5 V voltage supply to potentiometer and sensor • one analog output, 0-10 V, 0(4)-20 mA • two configurable digital inputs or open-collector outputs • two Pt100/Pt1000 inputs • LiqTec, dry-running protection sensor input • Grundfos Digital Sensor input and output • 24 V voltage supply for sensors • two signal-relay outputs (potential-free contacts) • GENIbus connection • interface for Grundfos CIM fieldbus module. <p data-bbox="124 1641 199 1668">Liquid:</p> <p data-bbox="124 1671 558 1697">Pumped liquid: Water</p> <p data-bbox="124 1700 611 1727">Liquid temperature range: -4 .. 248 °F</p> <p data-bbox="124 1729 550 1756">Selected liquid temperature: 68 °F</p> <p data-bbox="124 1758 606 1785">Density: 62.29 lb/ft³</p> <p data-bbox="124 1818 239 1845">Technical:</p> <p data-bbox="124 1848 742 1874">Pump speed on which pump data are based: 3467 rpm</p> <p data-bbox="124 1877 639 1904">Rated flow: 53.3 US GPM</p> <p data-bbox="124 1906 574 1933">Rated head: 305.8 ft</p> <p data-bbox="124 1935 564 1962">Actual impeller diameter: 3.66 in</p> <p data-bbox="124 1964 571 1991">Pump orientation: Vertical</p> <p data-bbox="124 1993 544 2020">Shaft seal arrangement: Single</p> <p data-bbox="124 2022 564 2049">Code for shaft seal: HQQE</p> <p data-bbox="124 2051 576 2078">Approvals: CURUS</p> <p data-bbox="124 2080 635 2107">Approvals for drinking water: NSF/ANSI 61</p> <p data-bbox="124 2110 683 2136">Curve tolerance: ISO9906:2012 3B</p>

Qty.	Description
	<p>Materials:</p> <p>Base: Cast iron EN 1561 EN-GJL-200 ASTM A48-25B</p> <p>Impeller: Stainless steel EN 1.4301 AISI 304</p> <p>Bearing: SIC</p> <p>Installation:</p> <p>t max amb: 104 °F</p> <p>Maximum operating pressure: 232.06 psi</p> <p>Max pressure at stated temp: 232 psi / 250 °F 232 psi / -4 °F</p> <p>Type of connection: ANSI / JIS</p> <p>Size of inlet connection: DN 50</p> <p>Size of outlet connection: DN 50</p> <p>Pressure rating for connection: PN 25</p> <p>Flange rating inlet: 300 lb</p> <p>Flange size for motor: 213TC</p> <p>Electrical data:</p> <p>Motor standard: NEMA</p> <p>Motor type: 132F</p> <p>IE Efficiency class: IE5</p> <p>Rated power - P2: 7.5 HP</p> <p>Power (P2) required by pump: 7.5 HP</p> <p>Mains frequency: 60 Hz</p> <p>Rated voltage: 3 x 200-240 V</p> <p>Service factor: 1.15</p> <p>Rated current: 20.0-16.6 A</p> <p>Cos phi - power factor: 0.94</p> <p>Rated speed: 360-4000 rpm</p> <p>Efficiency: 90.2%</p> <p>Motor efficiency at full load: 90.2 %</p> <p>Enclosure class (IEC 34-5): IP55</p> <p>Insulation class (IEC 85): F</p> <p>Motor No: 99301703</p> <p>Controls:</p> <p>Frequency converter: Built-in</p> <p>Pressure sensor: Y</p> <p>Others:</p> <p>DOE Pump Energy Index VL: 0.41</p> <p>Net weight: 194 lb</p> <p>Gross weight: 280 lb</p> <p>Shipping volume: 13.1 ft³</p>

99392015 CRE 10-8 N-GJ-A-E-HQQE 60 Hz



Note! All units are in [in] unless others are stated.