

PROJECT: _____	UNIT TAG: _____	QUANTITY: _____
REPRESENTATIVE: _____	TYPE OF SERVICE: _____	DATE: _____
ENGINEER: _____	SUBMITTED BY: _____	DATE: _____
CONTRACTOR: _____	APPROVED BY: _____	DATE: _____
	ORDER NO.: _____	DATE: _____



CRE 5-4 N-FGJ-A-E-HQQE

Vertical, multistage centrifugal pump with integrated frequency converter. The pump head and base are in cast iron - all other wetted parts are in stainless steel (EN 1.4301)

Note! Product picture may differ from actual product

Conditions of Service		Pump Data		Motor Data	
Liquid:	Water	Max pressure at stated temp:	363 psi / 250 °F	Rated power - P2:	1.5 HP
Temperature:	68 °F	Liquid temperature range:	-4 .. 248 °F	Rated voltage:	440-480 V
Specific Gravity:	1.000	Maximum ambient temperature:	122 °F	Mains frequency:	60 Hz
		Shaft seal:	HQQE	Enclosure class:	IP55
		Product number:	99340893	Insulation class:	F
				Motor protection:	ELEC
				Motor type:	80B
				Eta 1/1:	89.6 %

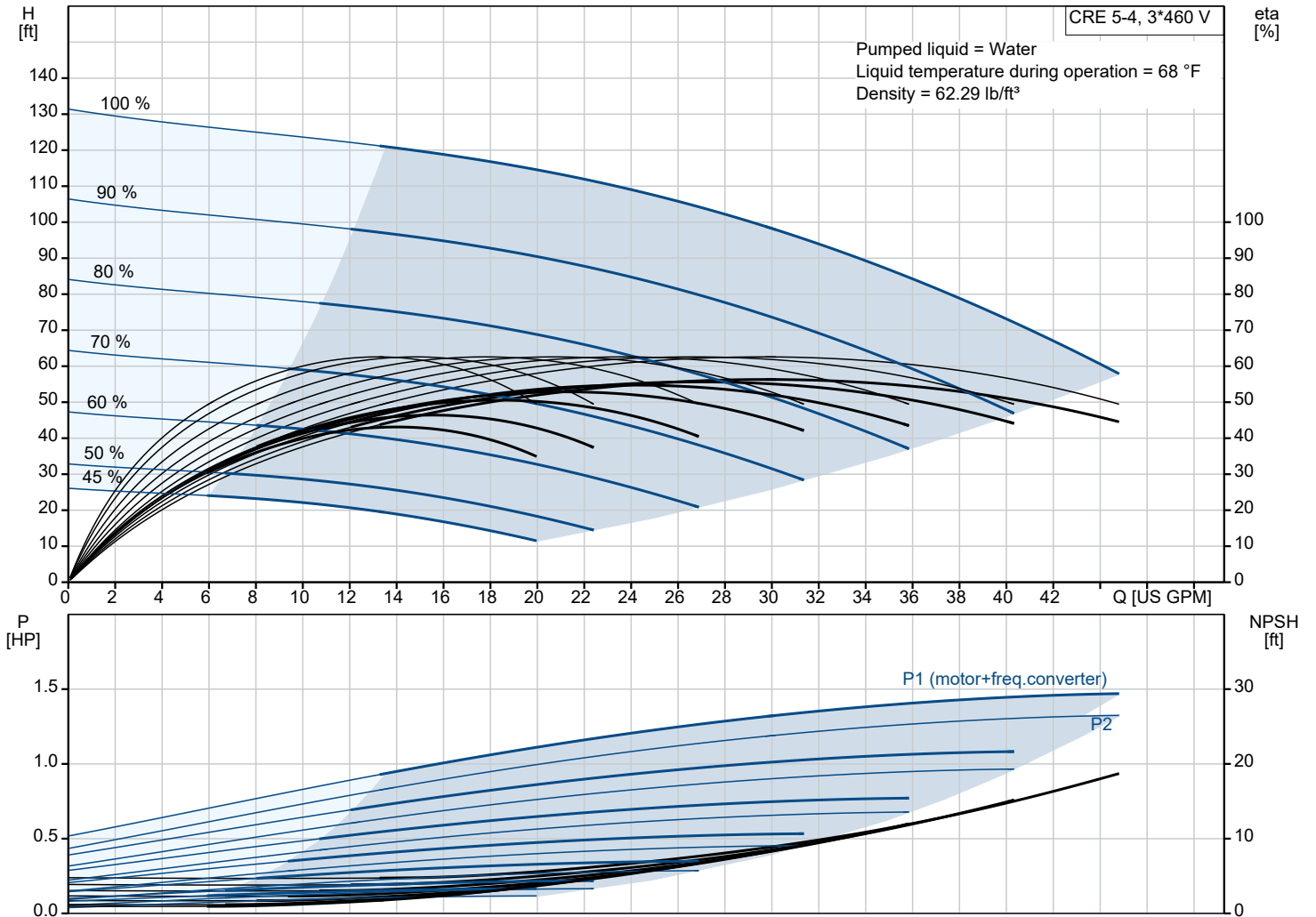

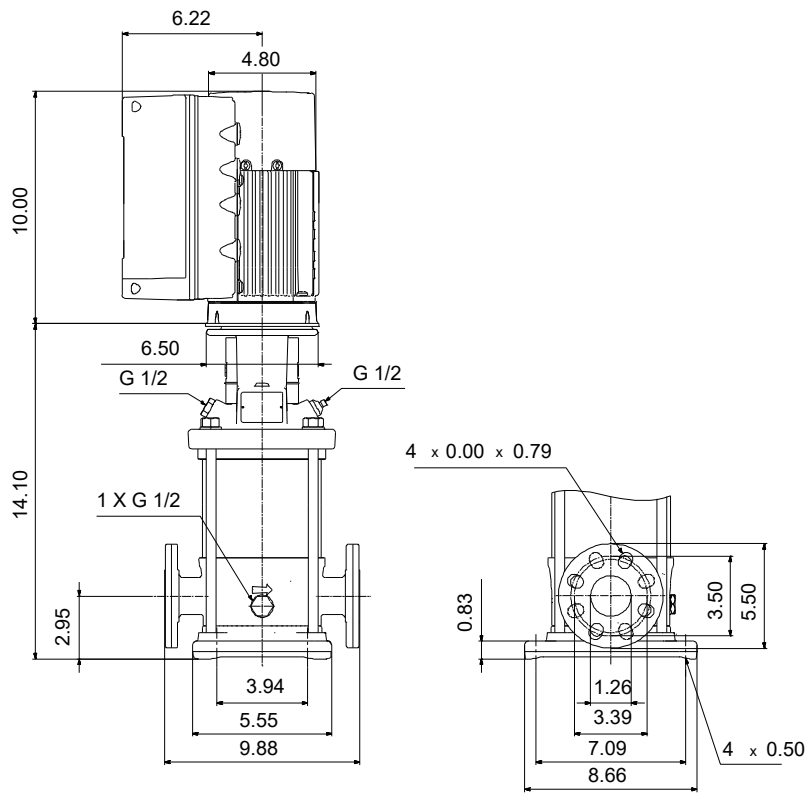

Materials:

Base: Cast iron
 Base: EN 1561 EN-GJL-200
 Base: ASTM A48-25B
 Impeller: Stainless steel
 Impeller: AISI 304
 Impeller: EN 1.4301
 Material code: A
 Code for rubber: E

Qty.	Description
------	-------------

1 **CRE 5-4 N-FGJ-A-E-HQQE**



Note! Product picture may differ from actual product

Product No.: [99340893](#)

Vertical, multistage centrifugal pump with inlet and outlet ports on same the level (inline). The pump head and base are in cast iron – all other wetted parts are in stainless steel. A cartridge shaft seal ensures high reliability, safe handling, and easy access and service. Power transmission is via a rigid split coupling. Pipe connection is via combined DIN-ANSI-JIS flanges.

The pump is fitted with a 3-phase, fan-cooled, permanent-magnet, synchronous motor.

The motor efficiency is classified as IE5 in accordance with IEC 60034-30-2.

The motor includes a frequency converter and PI controller in the motor terminal box. This enables continuously variable control of the motor speed, which again enables adaptation of the performance to a given requirement.

The operating panel on the motor terminal box features a four-inch TFT display, push-buttons and the Grundfos Eye indicator.

The display gives an intuitive and user-friendly interface to all functions.

The push-buttons are used to navigate through the menu structure to access pump and performance data on site and enable setting of required setpoint as well as setting of pump to "Min." or "Max." operation or to "Stop".

Communication with the pump is also possible by means of Grundfos GO Remote (accessory). The remote control enables further settings as well as reading out of a number of parameters such as "Actual value", "Speed", "Power input" and total "Power consumption".

The Grundfos Eye indicator on the operating panel provides visual indication of pump status:

- "Power on": Motor is running (rotating green indicator lights) or not running (permanently green indicator lights)
- "Warning": Motor is still running (rotating yellow indicator lights) or has stopped (permanently yellow indicator lights)
- "Alarm": Motor has stopped (flashing red indicator lights).

The terminal box has a number of inputs and outputs enabling the motor to be used in advanced applications where many inputs and outputs are required:

- two dedicated digital inputs
- three analog inputs, 0(4)-20 mA, 0-5 V, 0-10 V, 0.5 - 3.5 V; the factory-fitted pressure sensor is connected to one of these inputs
- 5 V voltage supply to potentiometer and sensor
- one analog output, 0-10 V, 0(4)-20 mA
- two configurable digital inputs or open-collector outputs
- two Pt100/Pt1000 inputs
- LiqTec, dry-running protection sensor input
- Grundfos Digital Sensor input and output
- 24 V voltage supply for sensors
- two signal-relay outputs (potential-free contacts)
- GENIbus connection
- interface for Grundfos CIM fieldbus module.

Liquid:

Pumped liquid: Water
 Liquid temperature range: -4 .. 248 °F
 Selected liquid temperature: 68 °F
 Density: 62.29 lb/ft³

Technical:

Pump speed on which pump data are based: 3466 rpm
 Rated flow: 30.4 US GPM
 Rated head: 94.82 ft
 Pump orientation: Vertical
 Shaft seal arrangement: Single
 Code for shaft seal: HQQE
 Approvals: CURUS
 Approvals for drinking water: NSF/ANSI 61
 Curve tolerance: ISO9906:2012 3B

Materials:

Qty.	Description
	<p>Base: Cast iron EN 1561 EN-GJL-200 ASTM A48-25B</p> <p>Impeller: Stainless steel EN 1.4301 AISI 304</p> <p>Bearing: SIC</p> <p>Installation:</p> <p>t max amb: 122 °F</p> <p>Maximum operating pressure: 362.59 psi</p> <p>Max pressure at stated temp: 363 psi / 250 °F 363 psi / -4 °F</p> <p>Type of connection: DIN / ANSI / JIS</p> <p>Size of inlet connection: DN 25/32</p> <p>Size of outlet connection: DN 25/32</p> <p>Pressure rating for connection: PN 25</p> <p>Flange rating inlet: 250 lb</p> <p>Flange size for motor: 56C</p> <p>Electrical data:</p> <p>Motor standard: NEMA</p> <p>Motor type: 80B</p> <p>IE Efficiency class: IE5</p> <p>Rated power - P2: 1.5 HP</p> <p>Power (P2) required by pump: 1.5 HP</p> <p>Mains frequency: 60 Hz</p> <p>Rated voltage: 3 x 440-480 V</p> <p>Service factor: 1.15</p> <p>Rated current: 2.05 A</p> <p>Cos phi - power factor: 0.84</p> <p>Rated speed: 360-4000 rpm</p> <p>Efficiency: 89.6%</p> <p>Motor efficiency at full load: 89.6 %</p> <p>Enclosure class (IEC 34-5): IP55</p> <p>Insulation class (IEC 85): F</p> <p>Motor No: 99256784</p> <p>Controls:</p> <p>Frequency converter: Built-in</p> <p>Pressure sensor: Y</p> <p>Others:</p> <p>Net weight: 70.3 lb</p> <p>Gross weight: 81.3 lb</p> <p>Shipping volume: 4.94 ft³</p>

99340893 CRE 5-4 N-FGJ-A-E-HQQE 60 Hz



Note! All units are in [in] unless others are stated.