

PROJECT: _____	UNIT TAG: _____	QUANTITY: _____
REPRESENTATIVE: _____	TYPE OF SERVICE: _____	DATE: _____
ENGINEER: _____	SUBMITTED BY: _____	DATE: _____
CONTRACTOR: _____	APPROVED BY: _____	DATE: _____
	ORDER NO.: _____	DATE: _____



CRN 125-5-2 A-G-A-V-HQQV

Vertical, multistage centrifugal pump with suction and discharge ports on the same level. Pump materials in contact with the liquid are in high-grade stainless steel (EN 1.4401)

Product photo could vary from the actual product

Conditions of Service		Pump Data		Motor Data	
Liquid:	Water	Liquid temperature range:	-4 .. 194 °F	Rated power - P2:	100 HP
Temperature:	68 °F	Maximum ambient temperature:	104 °F	Rated voltage:	460 V
Specific Gravity:	1.000	Shaft seal:	HQQV	Main frequency:	60 Hz
		Product number:	99918560	Enclosure class:	IP55
				Insulation class:	F
				Motor protection:	NONE
				Motor type:	WEG
				Eff. 1/1:	94.1 %

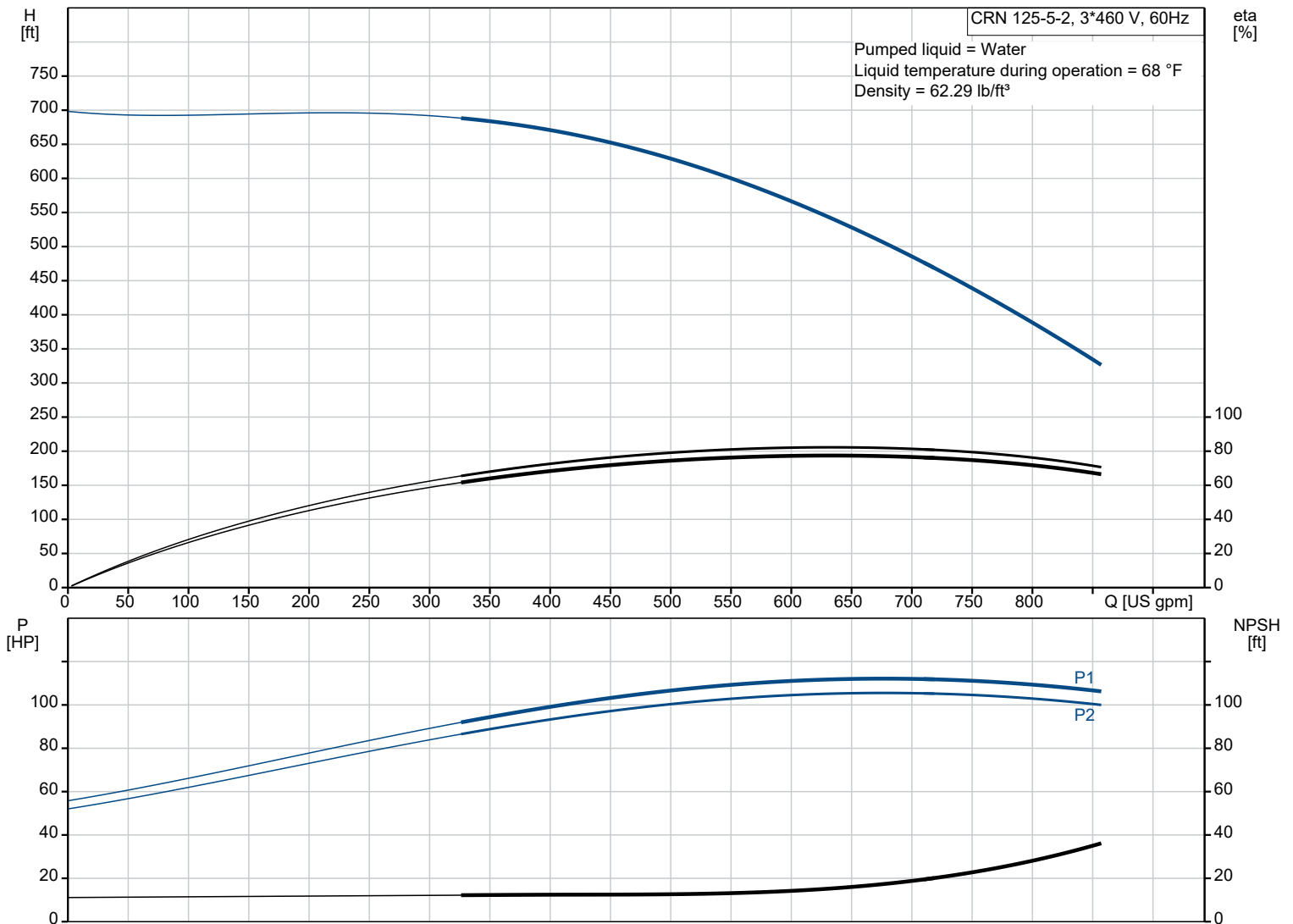

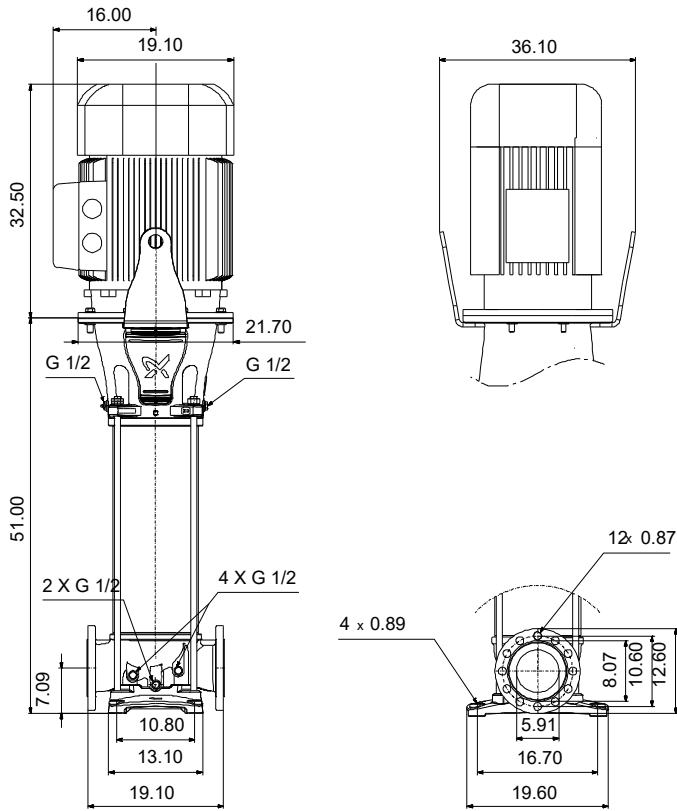

Materials:

- Base: Stainless steel
- Base: EN 1.4408
- Base: ASTM A351 CF8M
- Impeller: Stainless steel
- Impeller: AISI 316
- Impeller: EN 1.4401
- Material code: A
- Code for rubber: V

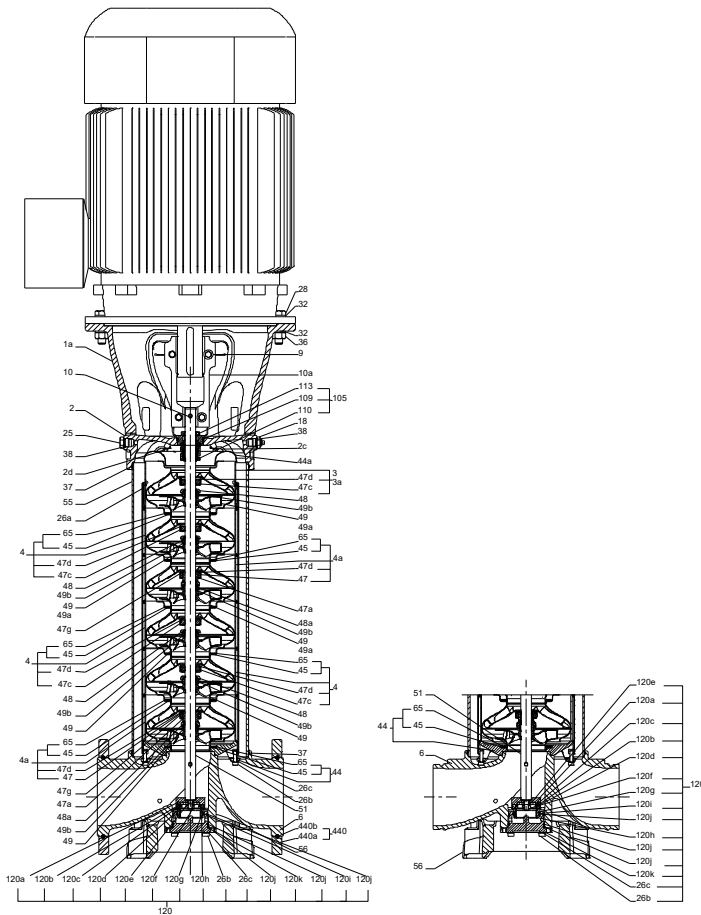

Description	Value
General information:	
Product name:	CRN 125-5-2 A-G-A-V-HQQV
Product No.:	99918560
EAN:	5715114134361
Technical:	
Rated pump speed:	3562 rpm
Rated flow:	660 US gpm
Rated head:	529.2 ft
Maximum head:	700.5 ft
Actual impeller diameter:	6.38 in
Stages:	5
Impellers:	5
Number of reduced-diameter impellers:	2
Low NPSH:	N
Pump orientation:	Vertical
Shaft seal arrangement:	Single
Code for shaft seal:	HQQV
Approvals for drinking water:	NSF/ANSI 372
Curve tolerance:	ISO9906:2012 3B
Pump version:	A
Model:	A
Cooling:	IC 411
Materials:	
Base:	Stainless steel
Base:	EN 1.4408
Base:	ASTM A351 CF8M
Impeller:	Stainless steel
Impeller:	EN 1.4401
Impeller:	AISI 316
Material code:	A
Code for rubber:	V
Bearing:	WC/WC
Thrust handling device:	SiC/WC
Material certified according to:	European standards
Installation:	
t max amb:	104 °F
Maximum operating pressure:	580.15 psi
Max pressure at stated temperature:	363 psi / 194 °F
Max pressure at stated temperature:	580.15 psi / 176 °F
Type of connection:	ANSI
Size of suction port:	6 inch
Size of outlet port:	6 inch
Pressure rating for connection:	300 lb
Flange size for motor:	405TSD
Connect code:	G
Liquid:	
Pumped liquid:	Water
Liquid temperature range:	-4 .. 194 °F
Selected liquid temperature:	68 °F
Density:	62.29 lb/ft ³
Electrical data:	
Motor standard:	NEMA
Motor type:	WEG
IE Efficiency class:	IE3 / NEMA Premium
Rated power - P2:	100 HP
Power (P2) required by pump:	100 HP
Main frequency:	60 Hz
Rated voltage:	3 x 460 V
Service factor:	1.25
Rated current:	112 A
Starting current:	650 %
Full load SF current:	140 A
Cos phi - power factor:	0.89
Rated speed:	3545 rpm
IE efficiency:	IE3 94,1%
Motor efficiency at full load:	94.1 %
Motor efficiency at 3/4 load:	94.1 %
Motor efficiency at 1/2 load:	93.0 %
Number of poles:	2
Enclosure class (IEC 34-5):	IP55
Insulation class (IEC 85):	F

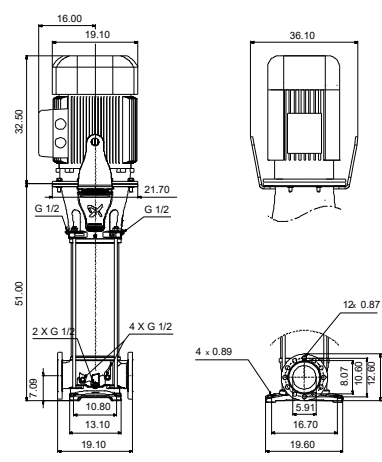
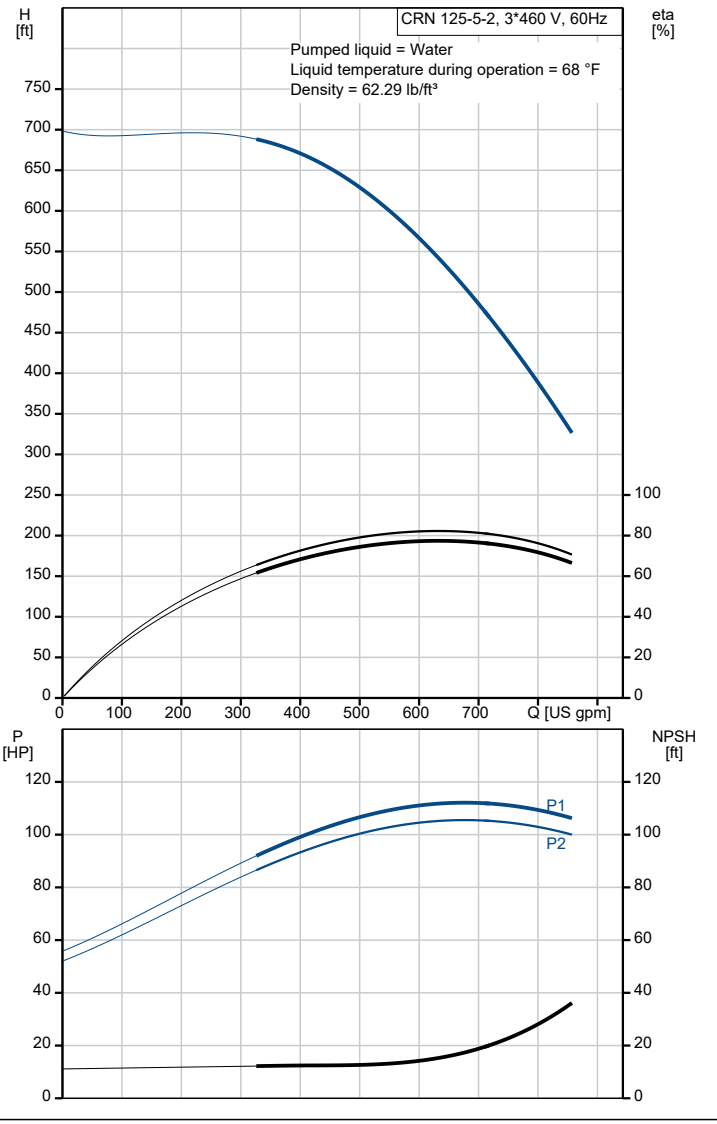

Description	Value
Built-in motor protection:	NONE
Motor Number:	99883216
Controls:	
Frequency converter:	NONE
Others:	
DOE Pump Energy Index CL:	0.93
Net weight:	1710 lb
Gross weight:	2200 lb
Shipping volume:	138 ft ³
Thrust handling device:	Y

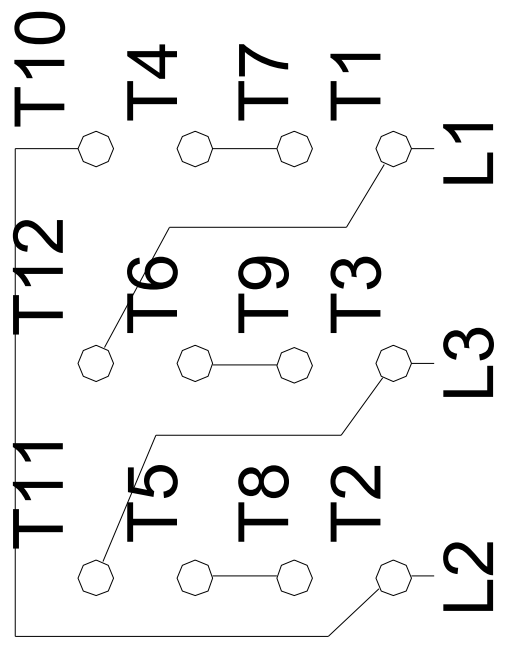

460//380-415

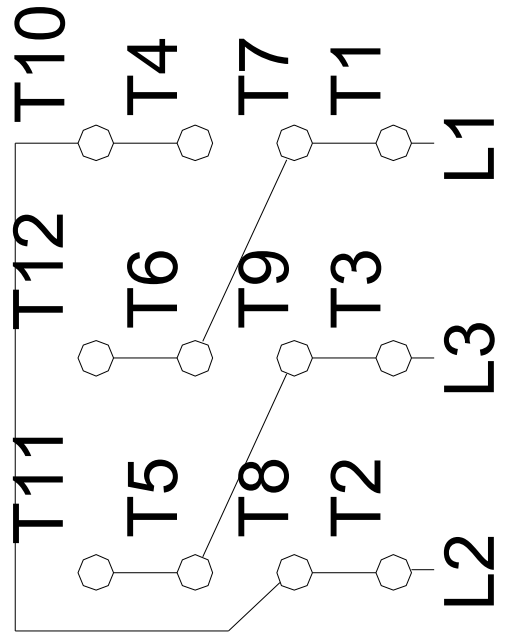

208-230V