

PROJECT:	UNIT TAG:	QUANTITY:
REPRESENTATIVE: _____	TYPE OF SERVICE:	DATE: _____
ENGINEER:	SUBMITTED BY:	DATE:
CONTRACTOR:	APPROVED BY:	DATE:
	ORDER NO.:	DATE:



CR 64-1 A-G-A-V-HQQV

Vertical, multistage centrifugal pump with suction and discharge ports on the same level. The pump head and base are in cast iron. All other wetted parts are in stainless steel (EN 1.4301) (AISI 304)

Product photo could vary from the actual product

Conditions of Service	Pump Data	Motor Data
Efficiency: _____	Max pressure at stated temperature: 232 psi / 194 °F	Rated power - P2: 15 HP
Liquid: Water	Liquid temperature range: -4 .. 194 °F	Rated voltage: 208-230/460 V
Temperature: 68 °F	Maximum ambient temperature: 104 °F	Main frequency: 60 Hz
NPSH required: ft	Shaft seal: HQQV	Enclosure class: IP55
Specific Gravity: 1.000	Product number: 99918295	Insulation class: F
		Motor protection: NONE
		Motor type: WEG
		Eff. 1/1: 91 %

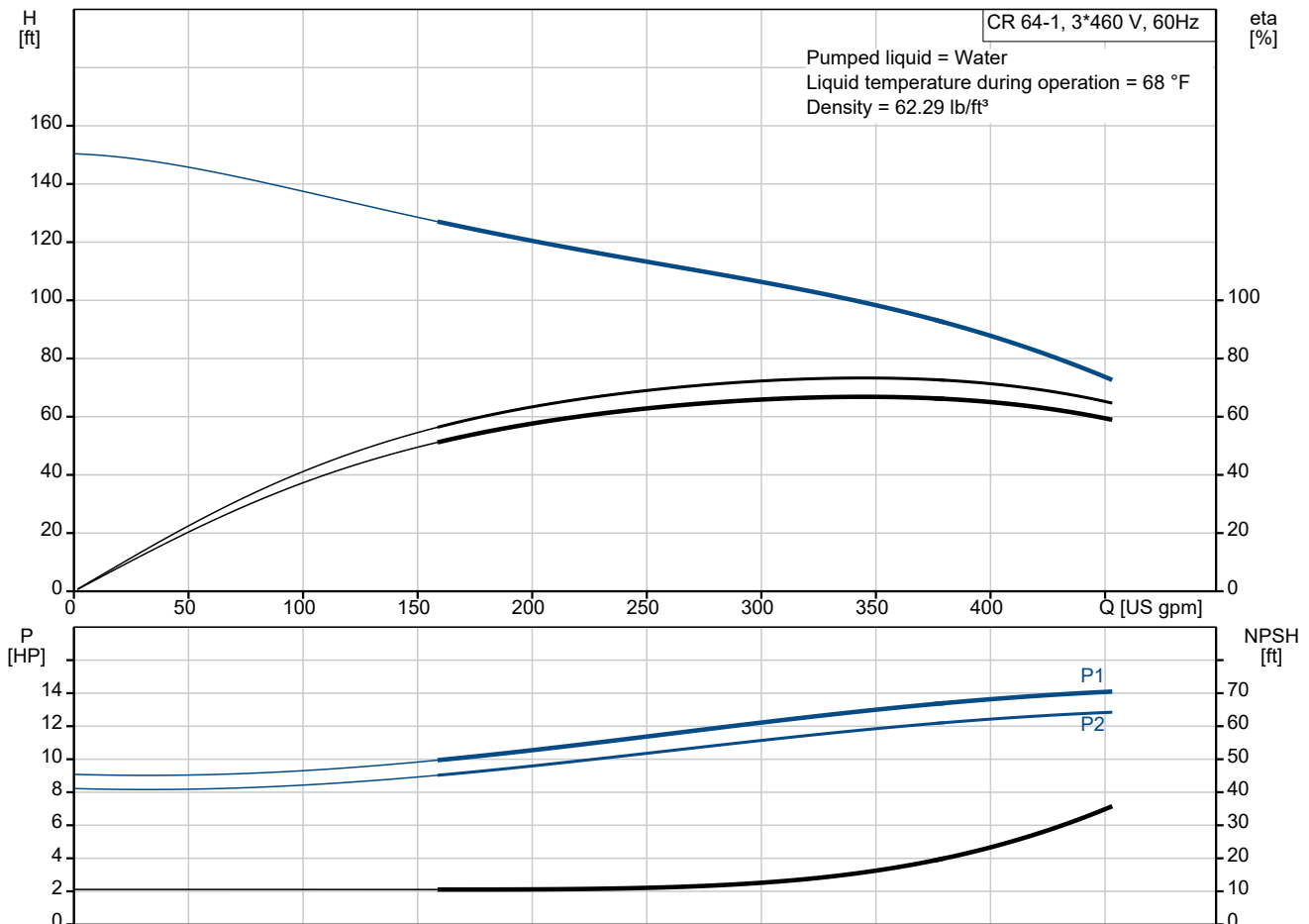

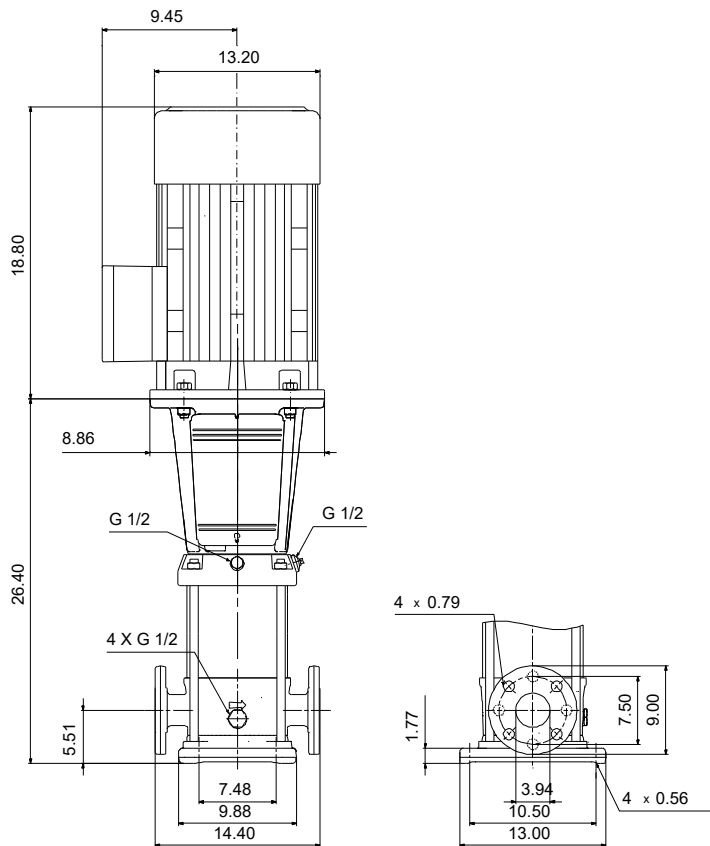

Materials:

Base: Cast iron
 Base: EN 1563 EN-GJS-500-7
 Base: ASTM A536 80-55-06
 Impeller: Stainless steel
 Impeller: AISI 304
 Impeller: EN 1.4301
 Material code: A
 Code for rubber: V

Description	Value
General information:	
Product name:	CR 64-1 A-G-A-V-HQQV
Product No.:	99918295
EAN:	5715114131612
Technical:	
Rated pump speed:	3444 rpm
Rated flow:	339 US gpm
Rated head:	103.4 ft
Maximum head:	153.9 ft
Actual impeller diameter:	5.59 in
Stages:	1
Impellers:	1
Number of reduced-diameter impellers:	0
Low NPSH:	N
Pump orientation:	Vertical
Shaft seal arrangement:	Single
Code for shaft seal:	HQQV
Approvals:	CURUS
Curve tolerance:	ISO9906:2012 3B
Pump version:	A
Model:	B
Cooling:	IC 411
Materials:	
Base:	Cast iron
Base:	EN 1563 EN-GJS-500-7
Base:	ASTM A536 80-55-06
Impeller:	Stainless steel
Impeller:	EN 1.4301
Impeller:	AISI 304
Material code:	A
Code for rubber:	V
Bearing:	SIC
Support bearing:	Graflon
Installation:	
t max amb:	104 °F
Maximum operating pressure:	232.06 psi
Max pressure at stated temperature:	232 psi / 194 °F
Max pressure at stated temperature:	232 psi / -4 °F
Type of connection:	ANSI
Size of suction port:	4 inch
Size of outlet port:	4 inch
Pressure rating for connection:	PN 16
Flange rating inlet:	150 lb
Flange size for motor:	254TC
Connect code:	G
Liquid:	
Pumped liquid:	Water
Liquid temperature range:	-4 .. 194 °F
Selected liquid temperature:	68 °F
Density:	62.29 lb/ft ³
Electrical data:	
Motor standard:	NEMA
Motor type:	WEG
IE Efficiency class:	IE3 / NEMA Premium
Rated power - P2:	15 HP
Power (P2) required by pump:	15 HP
KVA code:	L
Main frequency:	60 Hz
Rated voltage:	3 x 208-230/460 V
Service factor:	1.15
Rated current:	38,5-34,8/17,4 A
Starting current:	680-680 %
Full load SF current:	40/20 A
Cos phi - power factor:	0.87

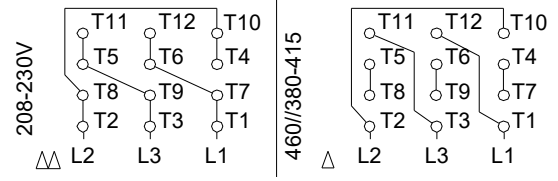
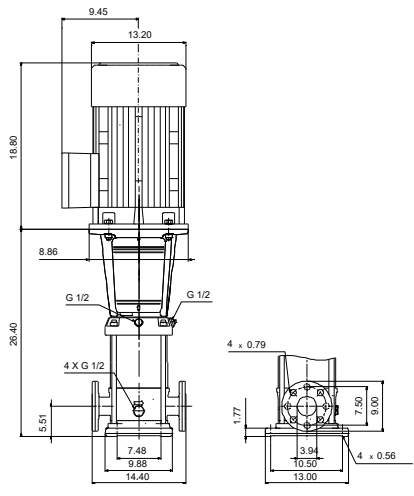
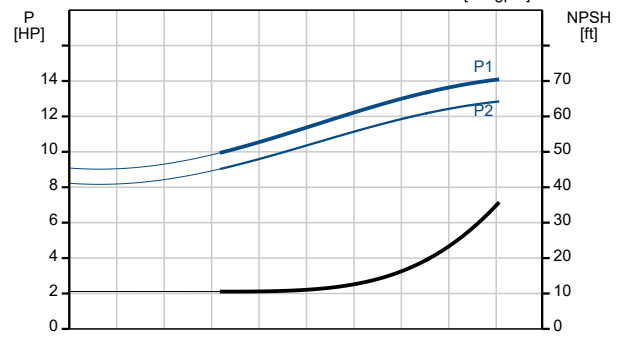
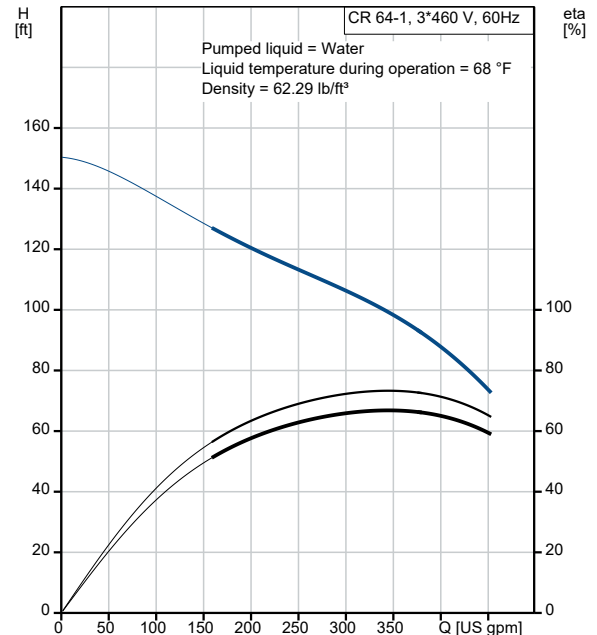

Description	Value
Rated speed:	3525 rpm
IE efficiency:	IE3 91%
Motor efficiency at full load:	91 %
Motor efficiency at 3/4 load:	91 %
Motor efficiency at 1/2 load:	89.5 %
Number of poles:	2
Enclosure class (IEC 34-5):	IP55
Insulation class (IEC 85):	F
Built-in motor protection:	NONE
Motor Number:	99883247
Controls:	
Frequency converter:	NONE
Others:	
DOE Pump Energy Index CL:	0.93
Net weight:	347 lb
Gross weight:	365 lb
Shipping volume:	29 ft ³
Country of origin:	US
Custom tariff no.:	8413.70.2040

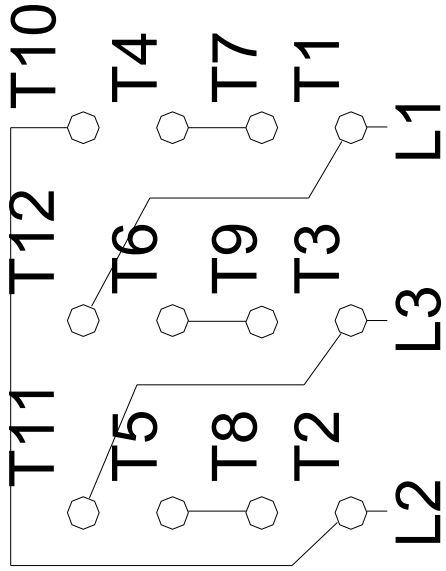

460//380-415

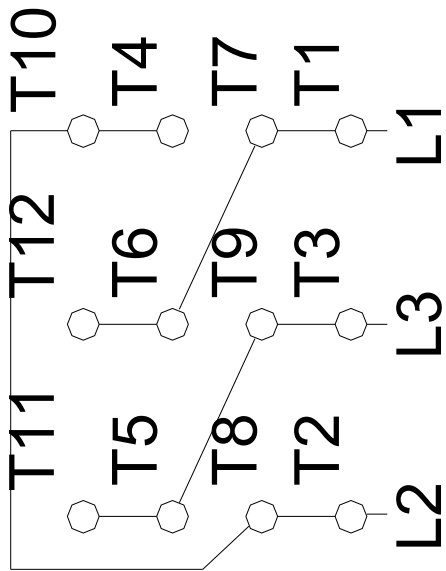

208-230V

All units are [in] unless otherwise presented.