

PROJECT:	UNIT TAG:	QUANTITY:
REPRESENTATIVE: _____	TYPE OF SERVICE:	DATE: _____
ENGINEER:	SUBMITTED BY:	DATE:
CONTRACTOR:	APPROVED BY:	DATE:
	ORDER NO.:	DATE:



### CRN 45-8-1 A-G-A-E-HQQE

Vertical, multistage centrifugal pump with suction and discharge ports on same the level. Pump materials in contact with the liquid are in high-grade stainless steel (EN 1.4401) (AISI 316)

Product photo could vary from the actual product

Conditions of Service	Pump Data	Motor Data
Efficiency: _____	Max pressure at stated temperature: 435 psi / 250 °F	Rated power - P2: 60 HP
Liquid: Water	Liquid temperature range: -40 .. 248 °F	Rated voltage: 208-230/460 V
Temperature: 68 °F	Maximum ambient temperature: 104 °F	Main frequency: 60 Hz
NPSH required: ft	Shaft seal: HQQE	Enclosure class: IP55
Specific Gravity: 1.000	Product number: 99918221	Insulation class: F
		Motor protection: NONE
		Motor type: WEG
		Eff. 1/1: 93.6 %

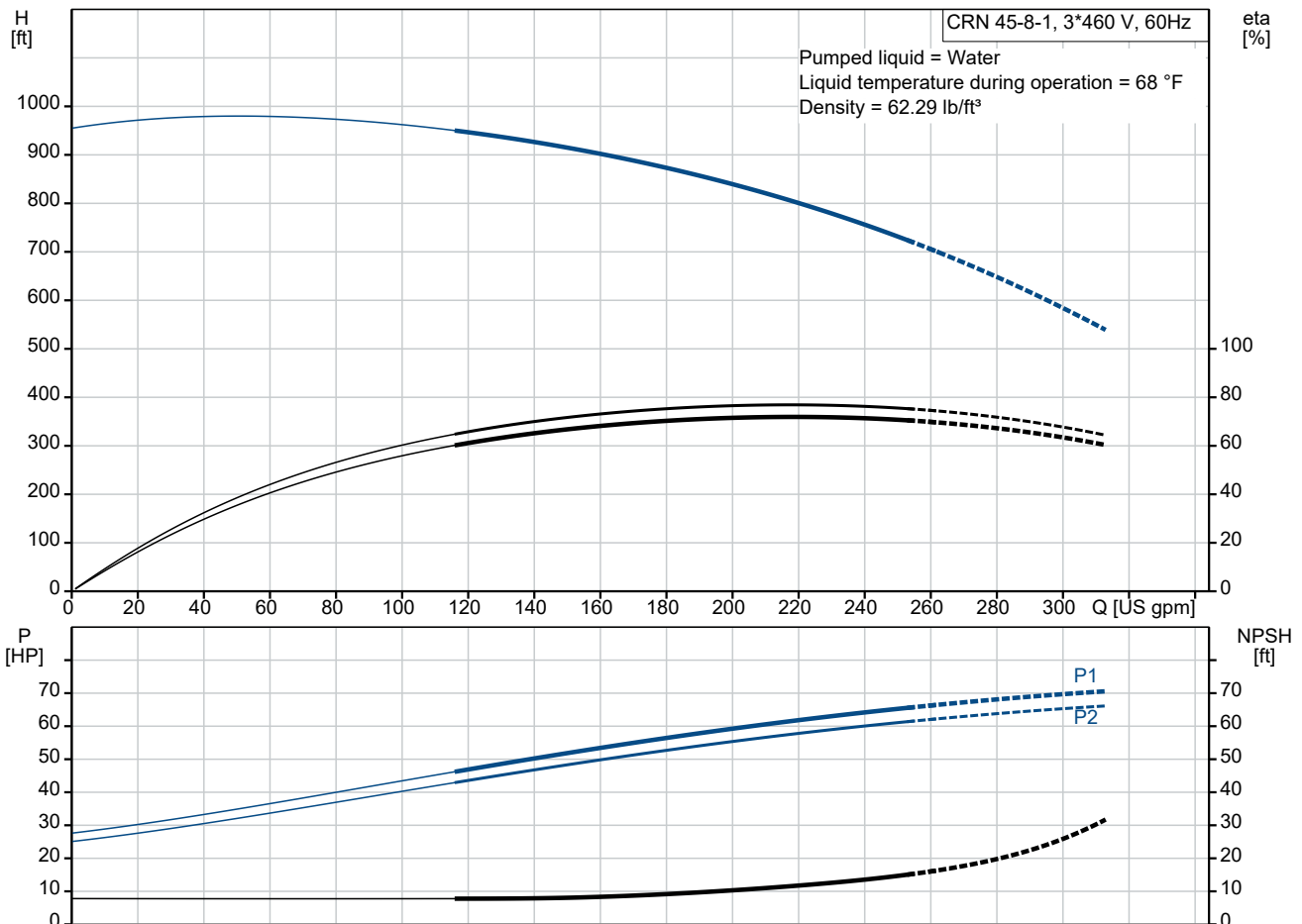

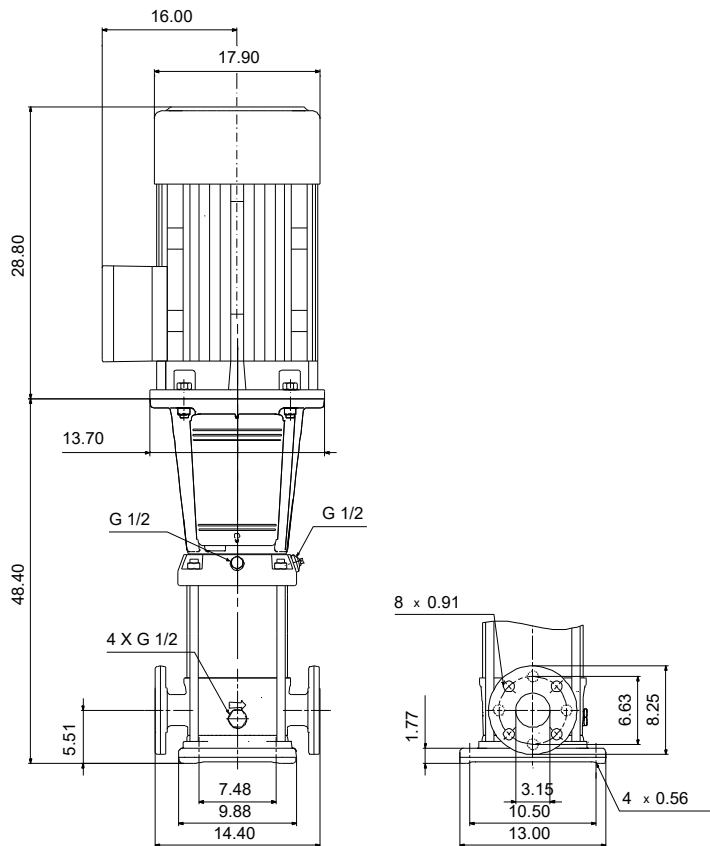

**Materials:**

Base: Stainless steel  
 Base: EN 1.4408  
 Base: AISI 316  
 Impeller: Stainless steel  
 Impeller: AISI 316  
 Impeller: EN 1.4401  
 Material code: A  
 Code for rubber: E

Description	Value
<b>General information:</b>	
Product name:	CRN 45-8-1 A-G-A-E-HQQE
Product No.:	99918221
EAN:	5715114130837
<b>Technical:</b>	
Rated pump speed:	3550 rpm
Rated flow:	238 US gpm
Rated head:	768.4 ft
Maximum head:	946.2 ft
Actual impeller diameter:	5.34 in
Stages:	8
Impellers:	8
Number of reduced-diameter impellers:	1
Low NPSH:	N
Pump orientation:	Vertical
Shaft seal arrangement:	Single
Code for shaft seal:	HQQE
Approvals:	CURUS
Approvals for drinking water:	NSF/ANSI 61
Curve tolerance:	ISO9906:2012 3B
Pump version:	A
Model:	B
Cooling:	IC 411
<b>Materials:</b>	
Base:	Stainless steel
Base:	EN 1.4408
Base:	AISI 316
Impeller:	Stainless steel
Impeller:	EN 1.4401
Impeller:	AISI 316
Material code:	A
Code for rubber:	E
Bearing:	SIC
Support bearing:	Graflon
<b>Installation:</b>	
t max amb:	104 °F
Maximum operating pressure:	435.11 psi
Max pressure at stated temperature:	435 psi / 250 °F
Max pressure at stated temperature:	435 psi / -40 °F
Type of connection:	ANSI
Size of suction port:	3 inch
Size of outlet port:	3 inch
Pressure rating for connection:	PN 40
Flange rating inlet:	300 lb
Flange size for motor:	364TC
Connect code:	G
<b>Liquid:</b>	
Pumped liquid:	Water
Liquid temperature range:	-40 .. 248 °F
Selected liquid temperature:	68 °F
Density:	62.29 lb/ft <sup>3</sup>
<b>Electrical data:</b>	
Motor standard:	NEMA
Motor type:	WEG
IE Efficiency class:	IE3 / NEMA Premium
Rated power - P2:	60 HP
Power (P2) required by pump:	60 HP
Main frequency:	60 Hz
Rated voltage:	3 x 208-230/460 V
Service factor:	1.25
Rated current:	148-134/67 A
Starting current:	660-660 %

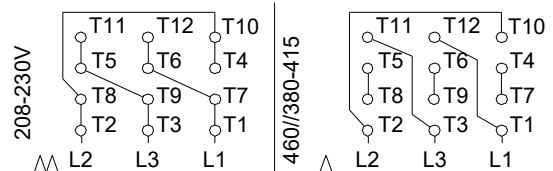
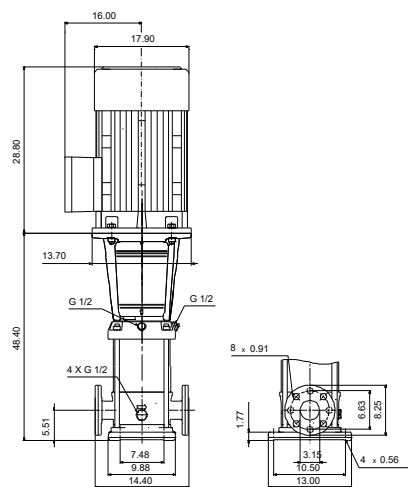
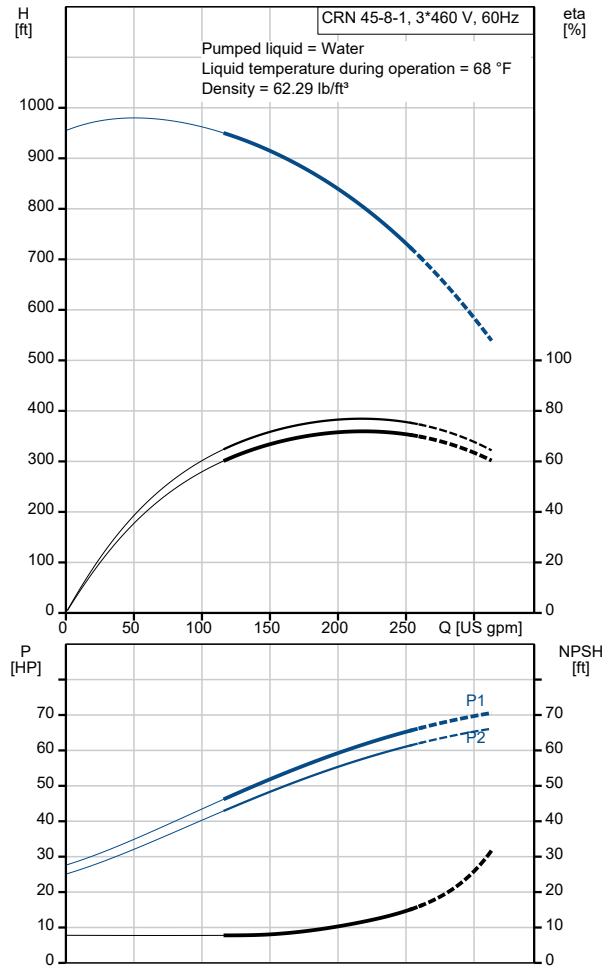

Description	Value
Full load SF current:	168/83.8 A
Cos phi - power factor:	0.90
Rated speed:	3560 rpm
IE efficiency:	IE3 93,6%
Motor efficiency at full load:	93.6 %
Motor efficiency at 3/4 load:	93 %
Motor efficiency at 1/2 load:	91.7 %
Number of poles:	2
Enclosure class (IEC 34-5):	IP55
Insulation class (IEC 85):	F
Built-in motor protection:	NONE
Motor Number:	99883253
<b>Controls:</b>	
Frequency converter:	NONE
<b>Others:</b>	
DOE Pump Energy Index CL:	0.89
Net weight:	1100 lb
Gross weight:	1350 lb
Shipping volume:	0 ft <sup>3</sup>
Country of origin:	US
Custom tariff no.:	8413.70.2040

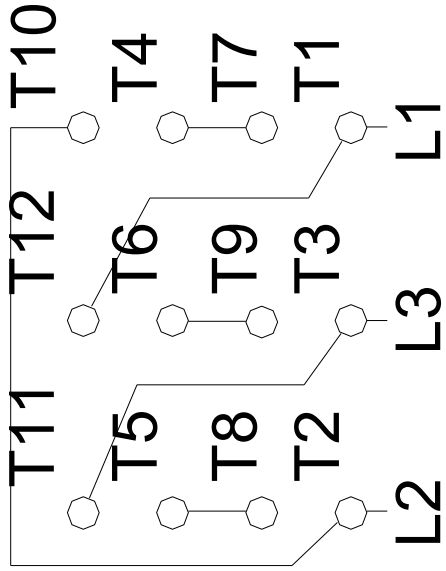

460//380-415

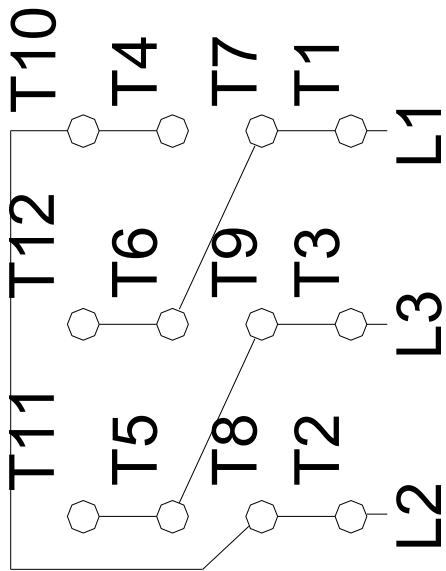

208-230V

All units are [in] unless otherwise presented.