

PROJECT:	UNIT TAG:	QUANTITY:
REPRESENTATIVE: _____	TYPE OF SERVICE:	DATE: _____
ENGINEER:	SUBMITTED BY:	DATE:
CONTRACTOR:	APPROVED BY:	DATE:
	ORDER NO.:	DATE:



### CRN 10-12 A-FGJ-A-E-HQQE

Vertical, multistage centrifugal pump with suction and discharge ports on same the level. Pump materials in contact with the liquid are in high-grade stainless steel (EN 1.4401) (AISI 316)

Product photo could vary from the actual product

Conditions of Service	Pump Data	Motor Data
Efficiency: _____	Max pressure at stated temperature: 363 psi / 250 °F	Rated power - P2: 10 HP
Liquid: Water	Liquid temperature range: -4 .. 248 °F	Rated voltage: 208-230/460 V
Temperature: 68 °F	Maximum ambient temperature: 104 °F	Main frequency: 60 Hz
NPSH required: ft	Shaft seal: HQQE	Enclosure class: IP55
Specific Gravity: 1.000	Product number: 99917404	Insulation class: F
		Motor protection: NONE
		Motor type: WEG
		Eff. 1/1: 90.2 %

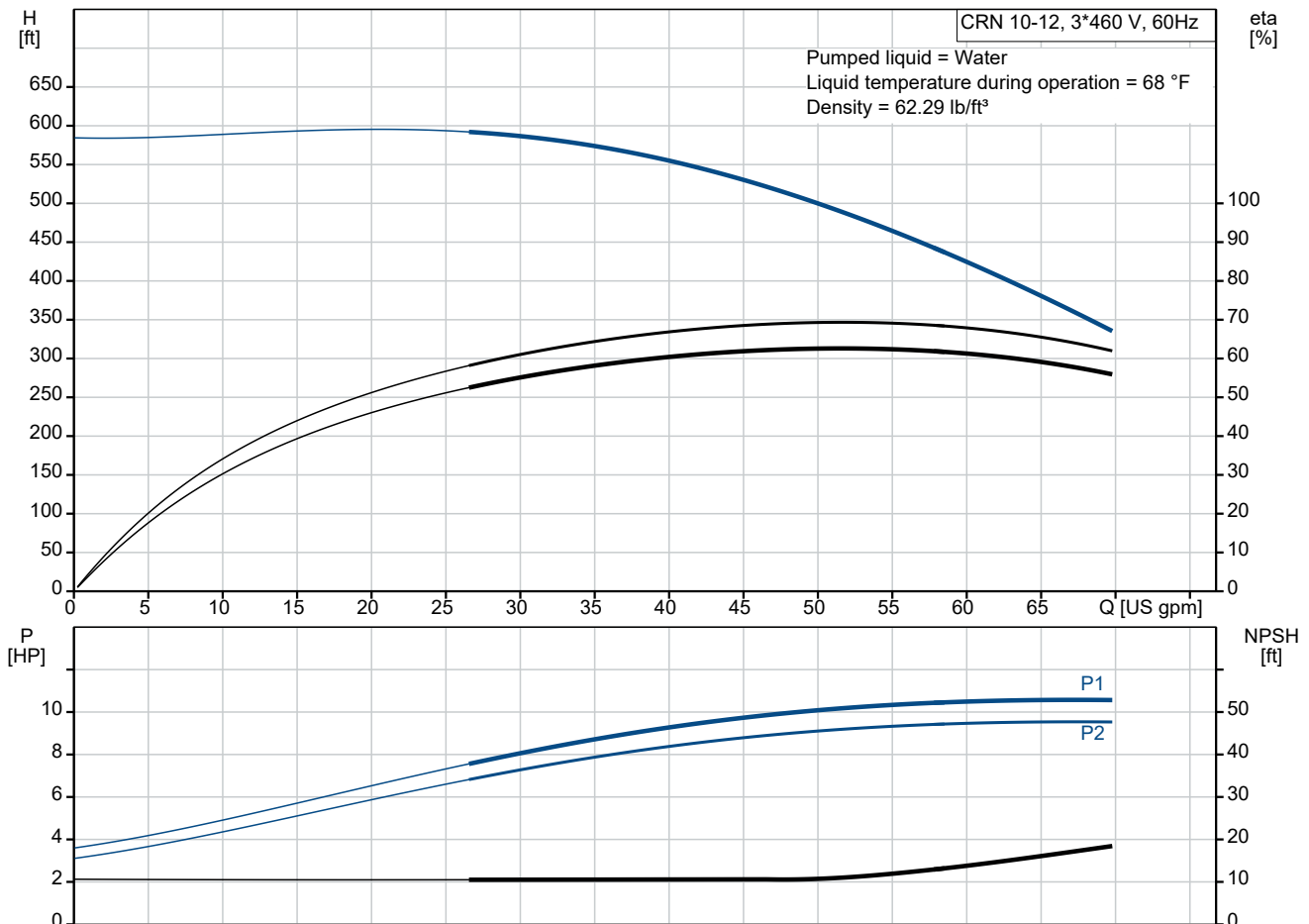

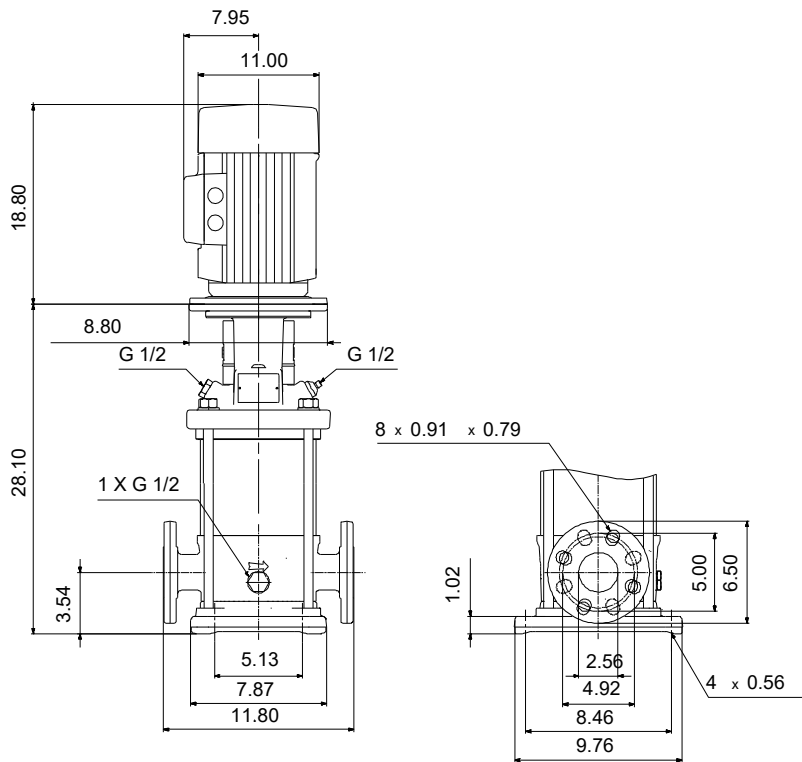

**Materials:**

Base: Stainless steel  
 Base: EN 1.4408  
 Base: AISI 316  
 Impeller: Stainless steel  
 Impeller: AISI 316  
 Impeller: EN 1.4401  
 Material code: A  
 Code for rubber: E

Description	Value
<b>General information:</b>	
Product name:	CRN 10-12 A-FGJ-A-E-HQQE
Product No.:	99917404
EAN:	5715114122092
<b>Technical:</b>	
Rated pump speed:	3470 rpm
Rated flow:	53.3 US gpm
Rated head:	446.5 ft
Maximum head:	577.5 ft
Actual impeller diameter:	3.66 in
Stages:	12
Impellers:	12
Number of reduced-diameter impellers:	0
Low NPSH:	N
Pump orientation:	Vertical
Shaft seal arrangement:	Single
Code for shaft seal:	HQQE
Approvals:	CURUS
Approvals for drinking water:	NSF/ANSI 61
Curve tolerance:	ISO9906:2012 3B
Pump version:	A
Model:	A
Cooling:	IC 411
<b>Materials:</b>	
Base:	Stainless steel
Base:	EN 1.4408
Base:	AISI 316
Impeller:	Stainless steel
Impeller:	EN 1.4401
Impeller:	AISI 316
Material code:	A
Code for rubber:	E
Bearing:	SIC
<b>Installation:</b>	
t max amb:	104 °F
Maximum operating pressure:	362.59 psi
Max pressure at stated temperature:	363 psi / 250 °F
Max pressure at stated temperature:	363 psi / -4 °F
Type of connection:	DIN / ANSI / JIS
Size of inlet connection:	DN 50
Size of outlet connection:	DN 50
Pressure rating for connection:	PN 25
Flange rating inlet:	300 lb
Flange size for motor:	213TC
Connect code:	FGJ
<b>Liquid:</b>	
Pumped liquid:	Water
Liquid temperature range:	-4 .. 248 °F
Selected liquid temperature:	68 °F
Density:	62.29 lb/ft <sup>3</sup>
<b>Electrical data:</b>	
Motor standard:	NEMA
Motor type:	WEG
IE Efficiency class:	IE3 / NEMA Premium
Rated power - P2:	10 HP
Power (P2) required by pump:	10 HP
Main frequency:	60 Hz
Rated voltage:	3 x 208-230/460 V
Service factor:	1.15
Rated current:	25,4-23,0/11,5 A
Starting current:	750-750 %
Full load SF current:	26.5/13.2 A

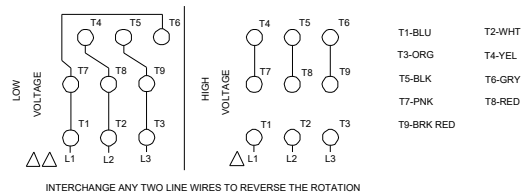
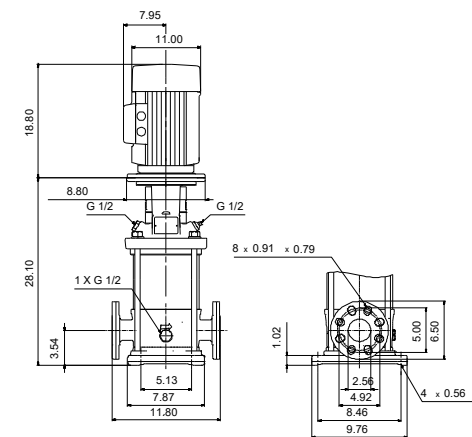
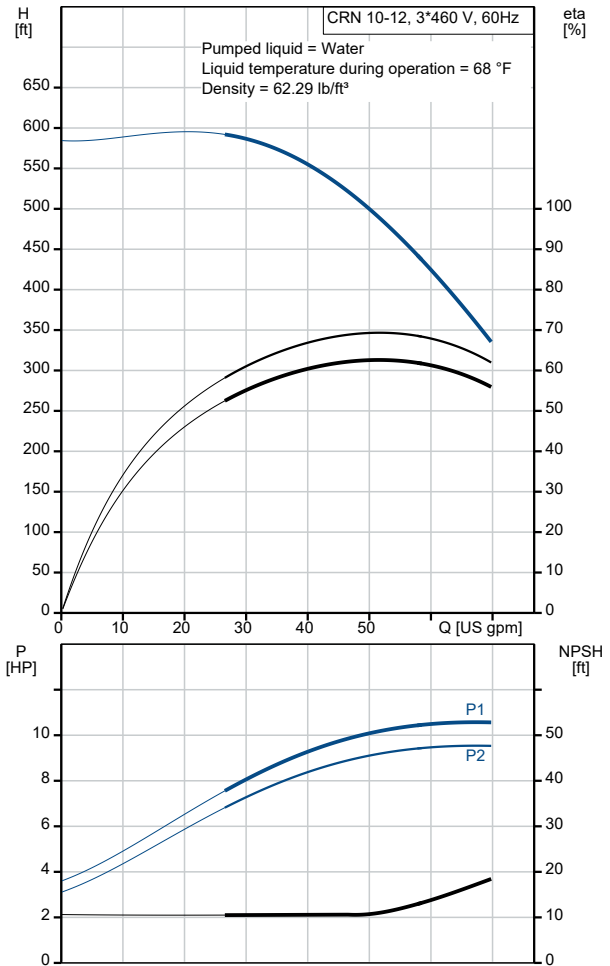

Description	Value
Cos phi - power factor:	0.91
Rated speed:	3530 rpm
IE efficiency:	IE3 90,2%
Motor efficiency at full load:	90.2 %
Motor efficiency at 3/4 load:	90.2 %
Motor efficiency at 1/2 load:	89.5 %
Number of poles:	2
Enclosure class (IEC 34-5):	IP55
Insulation class (IEC 85):	F
Built-in motor protection:	NONE
Motor Number:	99883246
<b>Controls:</b>	
Frequency converter:	NONE
<b>Others:</b>	
DOE Pump Energy Index CL:	0.87
Net weight:	278 lb
Gross weight:	298 lb
Shipping volume:	17.2 ft <sup>3</sup>
Country of origin:	US
Custom tariff no.:	8413.70.2040

# 99917404 CRN 10-12 A-FGJ-A-E-HQQE 60 Hz

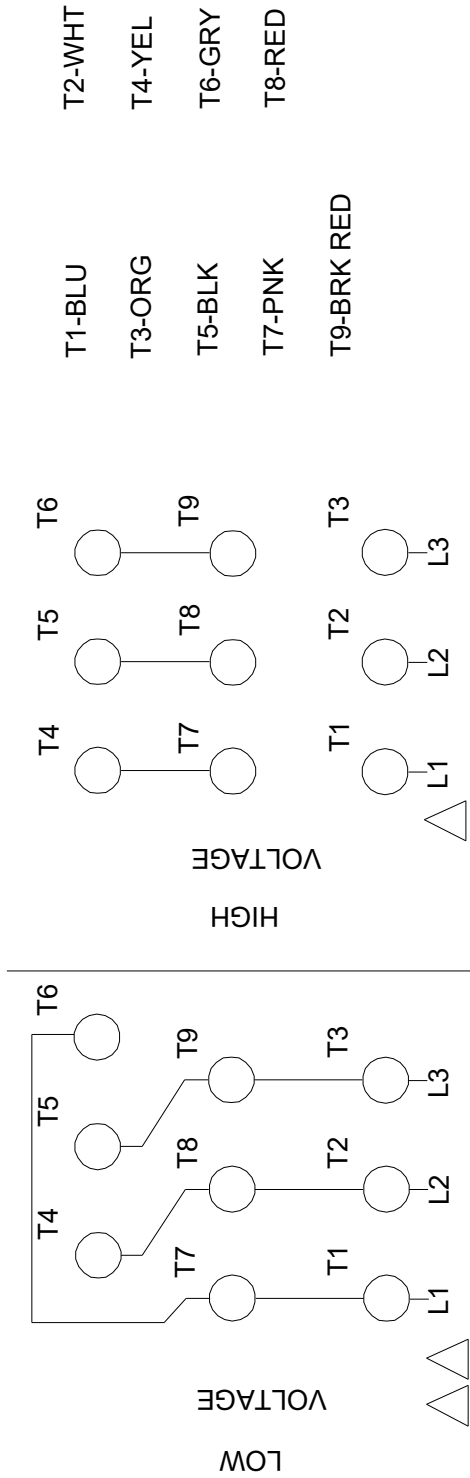

INTERCHANGE ANY TWO LINE WIRES TO REVERSE THE ROTATION

All units are [in] unless otherwise presented.