

PROJECT:	UNIT TAG:	QUANTITY:
REPRESENTATIVE: _____	TYPE OF SERVICE:	DATE: _____
ENGINEER:	SUBMITTED BY:	DATE:
CONTRACTOR:	APPROVED BY:	DATE:
	ORDER NO.:	DATE:



CRN 3-25 A-FGJ-A-V-HQQV

Vertical, multistage centrifugal pump with suction and discharge ports on same the level. Pump materials in contact with the liquid are in high-grade stainless steel (EN 1.4401) (AISI 316)

Product photo could vary from the actual product

Conditions of Service	Pump Data	Motor Data
Efficiency: _____	Max pressure at stated temperature: 363 psi / 194 °F	Rated power - P2: 5 HP
Liquid: Water	Liquid temperature range: -4 .. 194 °F	Rated voltage: 208-230/460 V
Temperature: 68 °F	Maximum ambient temperature: 104 °F	Main frequency: 60 Hz
NPSH required: ft	Shaft seal: HQQV	Enclosure class: IP55
Specific Gravity: 1.000	Product number: 99916661	Insulation class: F
		Motor protection: NONE
		Motor type: WEG
		Eff. 1/1: 88.5 %

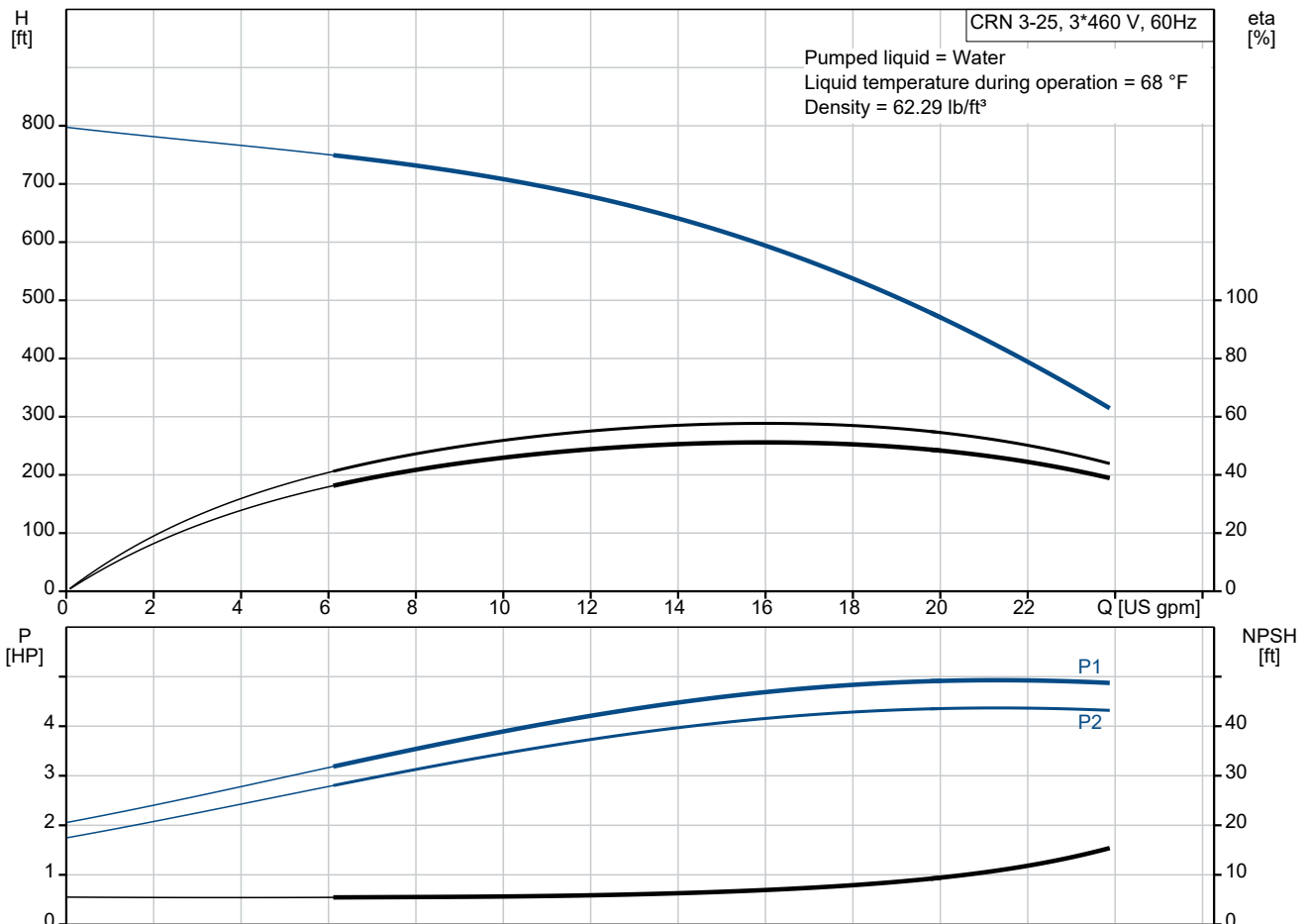

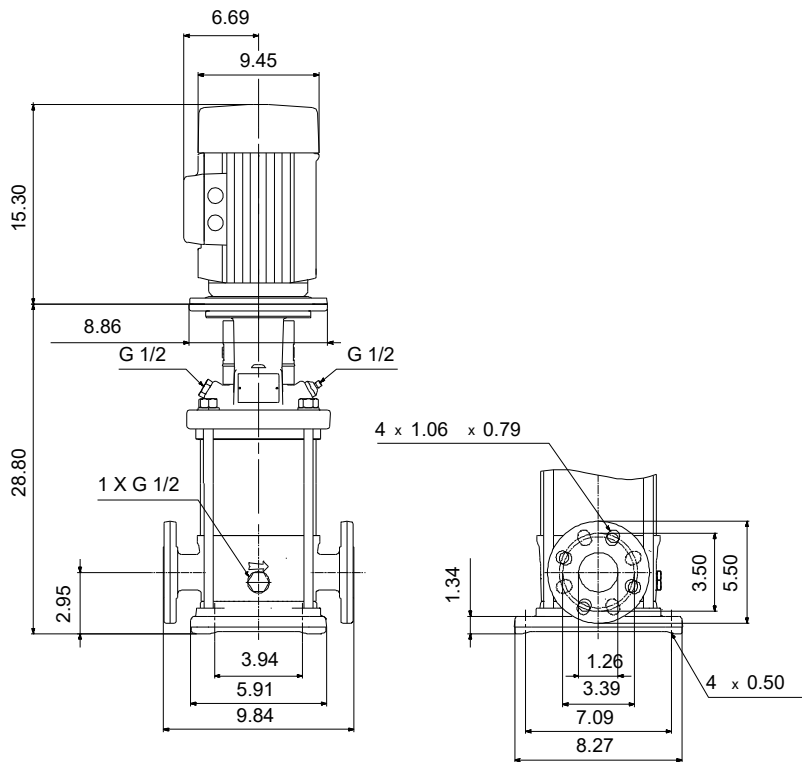

Materials:

Base: Stainless steel
 Base: EN 1.4408
 Base: AISI 316
 Impeller: Stainless steel
 Impeller: AISI 316
 Impeller: EN 1.4401
 Material code: A
 Code for rubber: V

Description	Value
General information:	
Product name:	CRN 3-25 A-FGJ-A-V-HQQV
Product No.:	99916661
EAN:	5715114114134
Technical:	
Rated pump speed:	3461 rpm
Rated flow:	15.4 US gpm
Rated head:	588.3 ft
Maximum head:	785.8 ft
Stages:	25
Impellers:	25
Number of reduced-diameter impellers:	0
Low NPSH:	N
Pump orientation:	Vertical
Shaft seal arrangement:	Single
Code for shaft seal:	HQQV
Approvals:	CURUS
Curve tolerance:	ISO9906:2012 3B
Pump version:	A
Model:	A
Cooling:	IC 411
Materials:	
Base:	Stainless steel
Base:	EN 1.4408
Base:	AISI 316
Impeller:	Stainless steel
Impeller:	EN 1.4401
Impeller:	AISI 316
Material code:	A
Code for rubber:	V
Bearing:	SIC
Installation:	
t max amb:	104 °F
Maximum operating pressure:	362.59 psi
Max pressure at stated temperature:	363 psi / 194 °F
Max pressure at stated temperature:	363 psi / -4 °F
Type of connection:	DIN / ANSI / JIS
Size of inlet connection:	DN 25/32
Size of outlet connection:	DN 25/32
Pressure rating for connection:	PN 25
Flange rating inlet:	300 lb
Flange size for motor:	182TC
Connect code:	FGJ
Liquid:	
Pumped liquid:	Water
Liquid temperature range:	-4 .. 194 °F
Selected liquid temperature:	68 °F
Density:	62.29 lb/ft ³
Electrical data:	
Motor standard:	NEMA
Motor type:	WEG
IE Efficiency class:	IE3 / NEMA Premium
Rated power - P2:	5 HP
Power (P2) required by pump:	5 HP
Main frequency:	60 Hz
Rated voltage:	3 x 208-230/460 V
Service factor:	1.15
Rated current:	13,1-11,8/5,9 A
Starting current:	780-780 %
Full load SF current:	13.6/6.79 A
Cos phi - power factor:	0.89
Rated speed:	3500 rpm

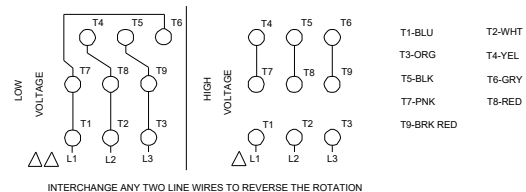
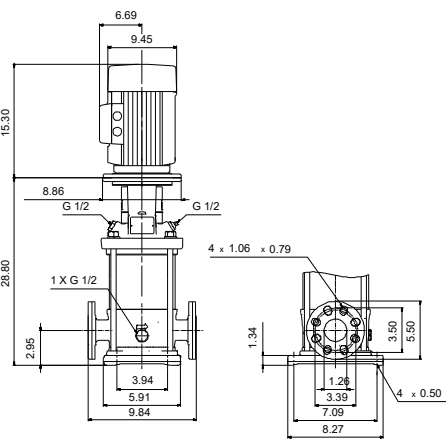
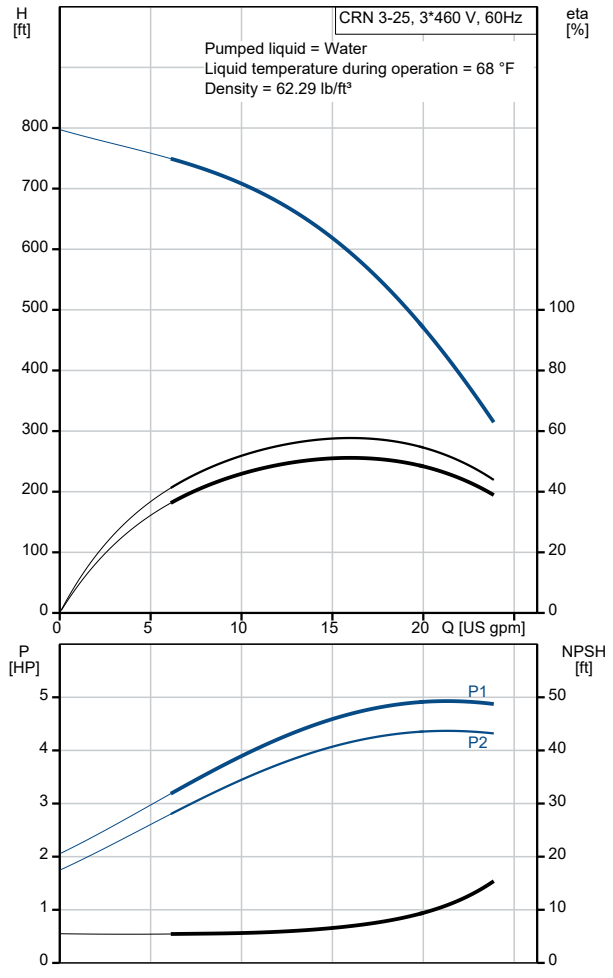

Description	Value
IE efficiency:	IE3 88,5%
Motor efficiency at full load:	88.5 %
Motor efficiency at 3/4 load:	88.5 %
Motor efficiency at 1/2 load:	87.5 %
Number of poles:	2
Enclosure class (IEC 34-5):	IP55
Insulation class (IEC 85):	F
Built-in motor protection:	NONE
Motor Number:	99882380
Controls:	
Frequency converter:	NONE
Others:	
Net weight:	144 lb
Gross weight:	162 lb
Shipping volume:	10.1 ft ³
Country of origin:	US
Custom tariff no.:	8413.70.2040

99916661 CRN 3-25 A-FGJ-A-V-HQQV 60 Hz



INTERCHANGE ANY TWO LINE WIRES TO REVERSE THE ROTATION

All units are [in] unless otherwise presented.