

Stamps  
ink pads  
DECALS  
Labels  
magnets  
Seals  
PENS  
Numberers  
photo  
gifts  
DECALS  
Banners  
signage  
DATERS  
Sticky  
Notes  
bonds  
TUMBLERS  
Handbooks  
name  
badges  
EMBOSSERS  
Letterhead  
business  
cards  
GIFT ITEMS  
Nameplates  
rubber stamps



**schwaab, inc**

SINCE  
1881

*Great Impressions that Last.*

# The Schwaab Difference

At Schwaab, we not only want to make a great impression for you, we want to make a great impression on you.

When Andrew Schwaab started the company in 1881 he had a basic philosophy for building a strong business; manufacture a quality product you can sell with pride, sell your products at a fair price and give every customer excellent service, whether the sale is for one item or thousands. These values have not changed.

Schwaab is a family owned company and a leader in manufacturing custom marking and identification products. We provide solutions to make branding simpler, work more convenient and life more organized. We know it's these small details that add professionalism and authenticity to your workplace.

Schwaab knows quick turnaround on orders is essential. With four manufacturing plants across the country, orders of any size or location can be manufactured timely.

Personal service is our number one priority at Schwaab. Experienced sales representatives can help bring your ideas to life, while our knowledgeable, on-site customer service team is ready to answer your questions.

We are proud of our history, our growth, our products and most importantly, our solutions to help you succeed.

*Contact us* today to find the right products for your specific needs.

## **National Accounts Program:**

Schwaab's National Accounts Program provides custom solutions to the unique needs of large national and Fortune 500 companies. Increased efficiency, unrivaled service and immediate savings are just a few benefits our national partners see right from the start. Other highlights include the ability to interface with E-Procurement programs, electronic ordering solutions, detailed reporting and multiple billing options. We also offer on demand production with no minimum order quantities.

*Contact Customer Service* to request more information about the National Accounts Program, pricing and support services.

**Satisfaction...** Schwaab assures your guaranteed satisfaction with a one-year warranty against defects on materials and workmanship.



# Table of Contents

<b>CUSTOM STAMPS</b> .....	<b>3</b>	<b>NAMEPLATES</b> .....	<b>29</b>
ExcelMark Pre-Inked Stamps.....	3	Wall Fasteners.....	29
XStamper Pre-Inked Stamps.....	5	Nameplate Inserts.....	29
XStamper Specialty Stamps.....	6	Nameplate Holders.....	30
XStamper Pocket Stamps.....	6	Sandblasted Glass Nameplate.....	31
Superslim Pre-Inked Stamps.....	6	Desk Wedges.....	31
ExcelMark Self-Inking Stamps.....	7	Acrylic Nameplates.....	32
Shiny Heavy Duty Self-Inking Stamps.....	8	<b>SIGNAGE</b> .....	<b>33</b>
ANTibac Self-Inking Stamps.....	8	Interior Signage Overview.....	33-34
Shiny Handy Self-Inking Stamps.....	8	Interior Signage Types.....	35-36
Rubber Stamps.....	9	Signage Collections.....	37-41
ExcelMark Self-Inking Date Stamps.....	10	All-in-One Sign Kit.....	42
ExcelMark Stock Message Date Stamps.....	10	Custom Signage Design Options.....	43
<b>DATE STAMPS + NUMBERERS</b> .....	<b>11</b>	Layout Templates.....	44
Trodat Professional Daters.....	11	Copy Styles.....	45
Trodat Dater / Stock Message Series.....	12	Symbol Options.....	46
Trodat Numberers.....	12	Color Charts.....	47-48
Trodat Line & Round Daters.....	13	Pattern Styles.....	49
XpeDater Date Stamps.....	14	Stock Signs.....	50
VersaDater Pre-Inked Date Stamps.....	14	Frame Options.....	51-53
XStamper Date Stamps.....	14	<b>BANNERS + CORRUGATED SIGNS</b> .....	<b>54</b>
Rubber Daters.....		Vinyl Banners.....	54
Local Style Daters.....	15	Corrugated Signs.....	54
Line Daters.....	15	<b>LABELS + DECALS</b> .....	<b>55</b>
Bridge Daters.....	15	Vinyl Decals.....	55
Flat Band Daters.....	15	Static Cling Decals.....	55
Double Daters.....	15	Bumper Stickers.....	55
Automatic Numbering Machines.....		Business Hour Window Decals.....	56
Econo Numbering Machine.....	16	Service Reminder Decals.....	56
Standard Numbering Machine.....	16	Floor and Wall Decals.....	57-58
Deluxe Numbering Machine.....	16	<b>PRINTED MATERIALS</b> .....	<b>59</b>
Numberers.....		Raised Print Business Cards.....	59
Self-Inking Numberers.....	16	Digital Full Color Business Cards.....	59
Rubber Numberers.....	16	Business Card Paper Stock and Ink Color Options.....	60
Alphabet Stamps, Cost & Selling and Alpha Numerical Stamps.....	16	Custom Printed Envelopes.....	61
<b>STOCK STAMPS</b> .....	<b>17</b>	Custom Printed Letterhead.....	62
Pre-Inked or Self-Inking Stock Stamps.....	17	Stock Business Forms.....	62
Large Stock Stamps.....	18	Custom Business Forms.....	62
Plastic Stock Message Stamps.....	18	Automotive Forms.....	63-64
Mini Stock Stamps.....	18	Vehicle Floor Mats.....	64
Identity Theft Guard Stamps.....	18	<b>PROMOTIONAL PRODUCTS</b> .....	<b>65</b>
<b>STAMP INK + PADS</b> .....	<b>19</b>	Custom Magnets.....	65-66
Stamp Replacement Pads.....	19	Car Magnets.....	67
Dater Replacement Pads.....	19	Sticky Notes.....	67
Marking Inks.....	20	Can Coolers.....	68
Ink Pads.....	20	Custom Tumblers.....	68
<b>NOTARY + PROFESSIONAL</b> .....	<b>21</b>	License Plate Inserts + Frames.....	69
Notary Stamps & Embossers.....	21	Custom Key Tags.....	70
Notary Supplies.....	21	Custom Pens.....	71-72
Notary Bundles.....	21	<b>GIFT ITEMS</b> .....	<b>73</b>
Notary Stamp Collection.....	22	Bamboo Cutting Boards.....	73
Notary Bonds and E&O Insurance.....	22	Personal Series Address Stamps.....	73
Notary Handbooks.....	22	Photo Gifts.....	74
Professional Stamps.....	23	Wine and Martini Sets.....	75-76
Professional Corporate Kits.....	23	<b>PROTECTION BARRIERS</b> .....	<b>77</b>
Embossers.....	24	Acrylic Protection Barriers.....	77
Seal Inker.....	24	<b>GENERAL INFORMATION</b> .....	<b>78</b>
Gold Foil Seals.....	24	Order Form.....	78
<b>NAME BADGES</b> .....	<b>25</b>		
Classic Engraved Badges.....	25		
Designer Engraved Badges.....	25		
Full Color Plastic Badges.....	26		
Full Color Aluminum Badges.....	26		
Designer Full Color Badges.....	27		
Pocket Badges.....	27		
Reusable Window Badges.....	27		
Reusable Message Badges.....	28		
Photo ID Badges.....	28		
Badge Accessories.....	28		



## Pre-Inked Stamps

- Sharp, high-quality, crisp impressions
- Re-inkable
- Pre-inked for up to 20,000 impressions
- *Lifetime guarantee*

### Available Colors

- Black
- Red
- Blue
- Green
- Purple

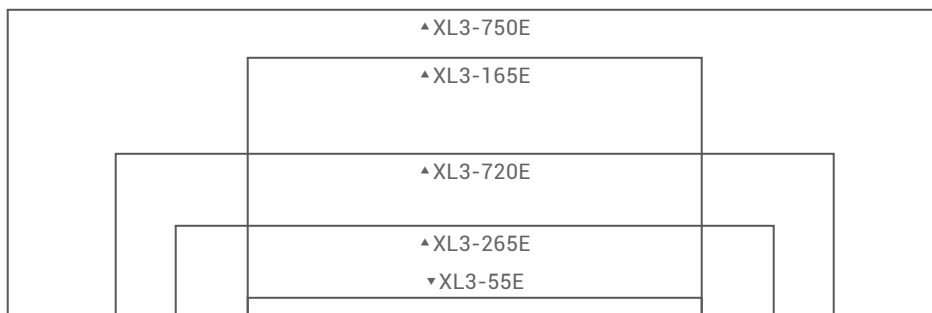
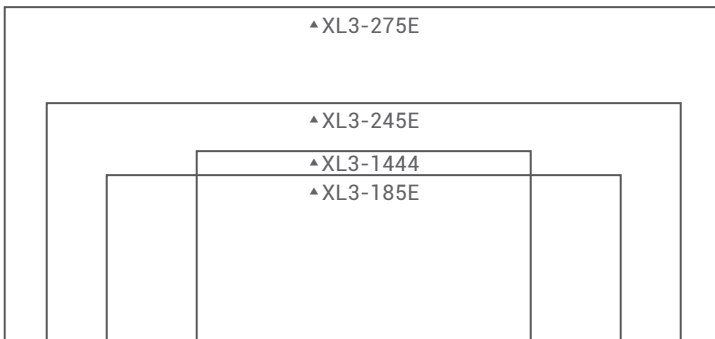
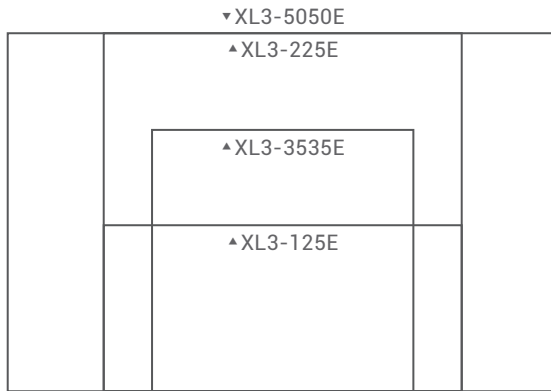

## ExcelMark

### ExcelMark Pre-Inked Stamps

Item #	Impression Area	Max. # of Lines
XL3-55E	1/8" x 2 3/8"	1
XL3-125E	7/8" x 1 7/8"	6
XL3-165E	1 3/8" x 2 3/8"	10
XL3-185E	7/8" x 2 11/16"	6
XL3-225E	1 7/8" x 2 7/8"	12
XL3-245E	1 1/4" x 3 5/16"	8
XL3-265E	1/2" x 3 1/8"	3
XL3-275E	1 3/4" x 3 3/4"	10
XL3-720E	7/8" x 3 3/4"	5
XL3-750E	1 5/8" x 4 7/8"	10
XL3-1444	1" x 1 3/4"	4
XL3-3535E	1 3/8" x 1 3/8"	7
XL3-5050E	1 7/8" x 1 7/8"	12
XL3-305E	5/16" Diameter	2
XL3-325E	1/2" Diameter	3
XL3-495E	1 1/16" Diameter	5
XL3-535E	1 1/2" Diameter	9
XL3-655E	2" Diameter	12
51103	Signature	N/A

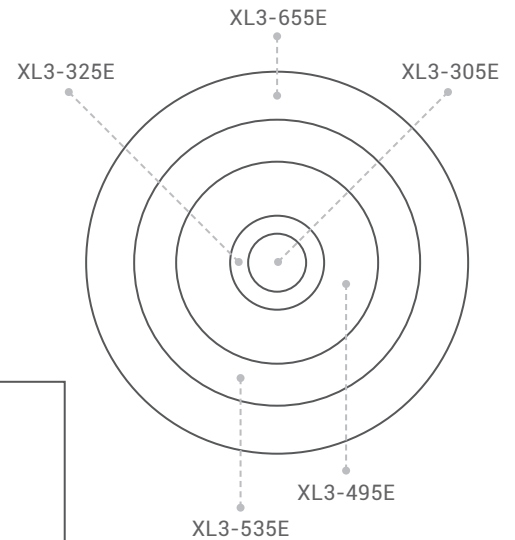

*Lauren Meyer*

51103 | Signature Stamp

# ExcelMark Modico

## ExcelMark Modico Pre-Inked Stamps

Item #	Impression Area	Max. # of Lines
E20	$7/16" \times 1 7/16"$	2
E30	$9/16" \times 1 15/16"$	3
E40	$1 3/16" \times 2 1/4"$	3
E50	$7/8" \times 2 1/2"$	6
E60	$1 5/16" \times 2 1/2"$	9
E100	$1 3/4" \times 3 1/2"$	9
E120	$2 7/16" \times 3 3/8"$	16
E140	$2 11/16" \times 3 7/8"$	16
E25	$7/8"$ Diameter	4
E45	$1 5/8"$ Diameter	9
G104478	$1 5/8" \times 1 5/8"$	10



## ExcelMark Re-Inking Instructions



### Step 1

Slide the ink cartridge out of the unit.



### Step 2

Add 3-4 drops of ink to the openings.



### Step 3

Slide the ink cartridge back into the unit.

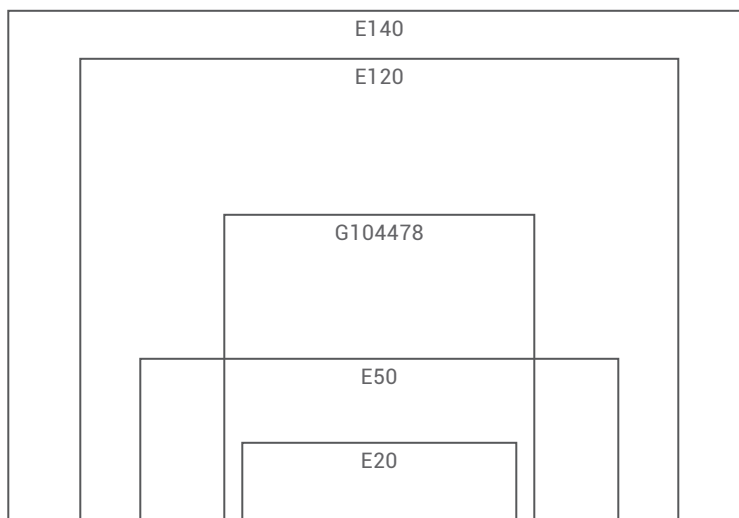
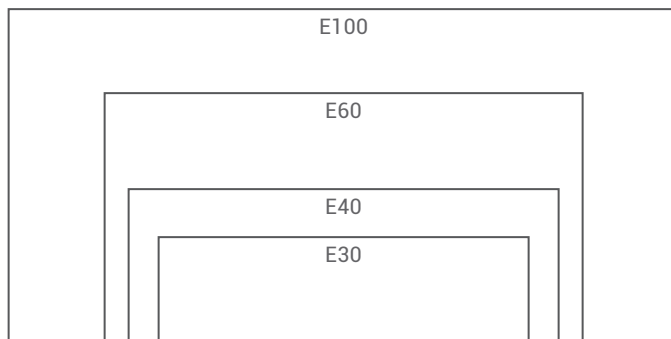
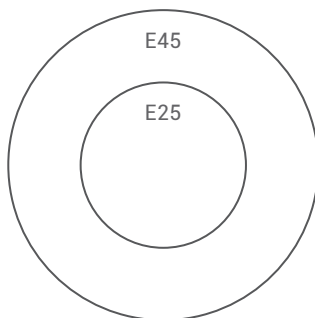

# XStamper



- Pre-inked for an initial 50,000 impressions.
- Re-inkable.
- Ergonomic ABS plastic handle is designed for durability.
- Stamp material is laser engraved to provide a perfect impression every time.
- Our ECO-GREEN mounts are made from at least 50% post-consumer content.

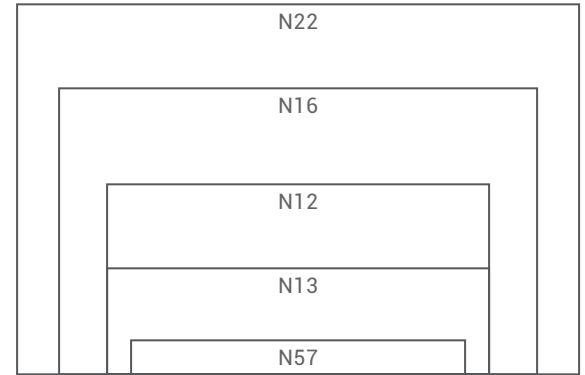
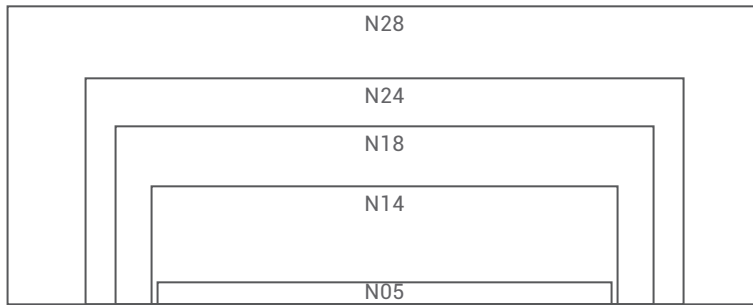
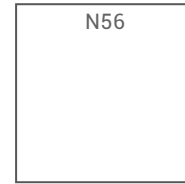
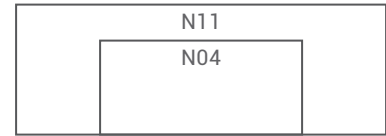
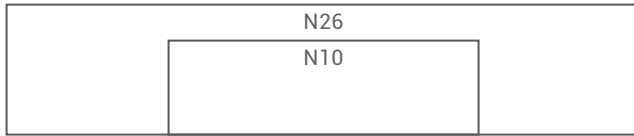

## XStamper Pre-inked Custom Stamps

Item #	Impression Area	Max. # of Lines
N04	1/2" x 1 1/16"	4
N05	1/8" x 2 3/8"	1
N10	1/2" x 1 5/8"	4
N11	1 1/16" x 1 15/16"	6
N12	1" x 2"	9
N13	9/16" x 2"	5
N14	5/8" x 2 7/16"	5
N16	1 1/2" x 2 1/2"	13
N18	1 5/16" x 2 13/16"	7
N22	1 15/16" x 2 15/16"	17
N24	1 3/16" x 3 1/8"	10
N26	1 1/16" x 3 5/16"	6
N27	1 9/16" x 3 15/16"	13
N28	2 9/16" x 3 15/16"	22
N32	5/8" Diameter	3
N48	3/4" Diameter	3
N49	1 3/16" Diameter	5
N51	1 5/16" Diameter	4
N53	1 9/16" Diameter	7
N56	1 5/16" x 1 5/16"	8
N57	3/16" x 1 3/4"	6

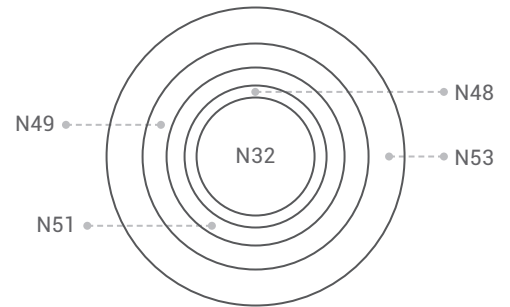



N06



N30



N44



N60



N47



N37

### XStamper Pre-Inked Custom Specialty Stamps

Item #	Impression Area	Max. # of Lines
N06	¼" Diameter	1
N30	⅜" Diameter	2
N37	⅜" x 1 9/16"	1
N44	⅜" Diameter	3
N47	1 3/16" Diameter	5
N60	½" Diameter	3

## XStamper Specialty Stamps

- These stamps have unique mounts, which make them ideal for Inspection and Quality-Control tasks.

## XStamper Pocket Stamps

- This stamps handle is also a very handy carrying case.
- Won't leak in a pocket or purse so it's great on the go.



N40

N42

### XStamper Pre-Inked Custom Pocket Stamps

Item #	Impression Area	Max. # of Lines
N40	½" x 2"	4
N42	⅝" x 2 7/16"	5

## Superslim



**COMPACT MOUNT**  
designed to be carried with you.

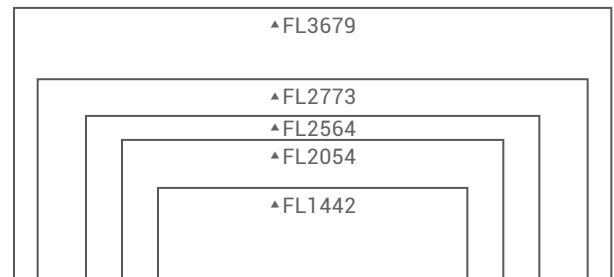

### Superslim Pre-Inked Stamps

Item #	Impression Area	Max. # Of Lines
FL1442	½" x 1 5/8"	3
FL2054	¾" x 2"	4
FL2564	7/8" x 2 3/8"	6
FL2773	1 1/16" x 2 7/8"	6
FL3679	1 7/16" x 3 1/8"	8

## Self-Inking Stamps

- Includes a unique, two-sided ink pad that doubles the number of impressions and the useful life of the pad
- Re-inkable
- Attractive, clear mount which allows you to accurately line up your stamp impression
- Ideal for rapid, repetitive stamping

### Available Colors

- Black
- Red
- Blue
- Green
- Purple
- Brown

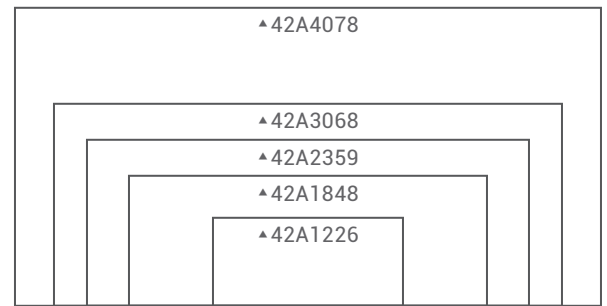
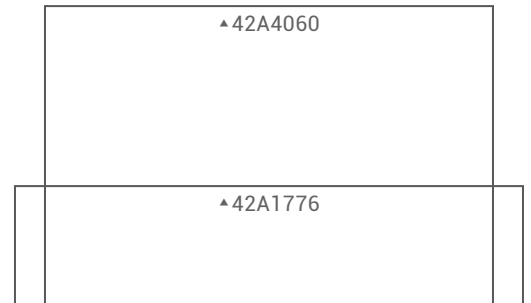
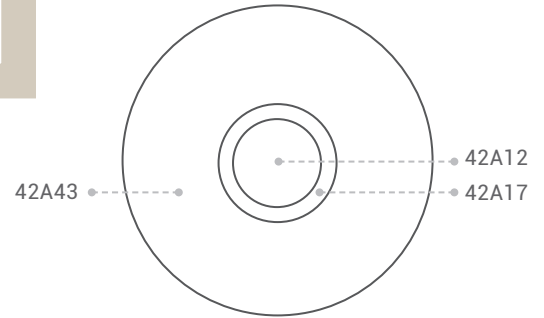
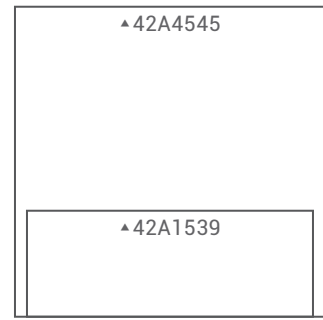

### ExcelMark Self-Inking Stamps

Item #	Impression Area	Max. # of Lines	Replacement Pad
42A1226	1 <sup>5</sup> / <sub>32</sub> " x 1"	2	46A1226
42A1539	9 <sup>1</sup> / <sub>16</sub> " x 1 1/2"	3	46A1539
42A1776	5/8" x 2 <sup>21</sup> / <sub>32</sub> "	3	46A1776
42A1848	1 <sup>1</sup> / <sub>16</sub> " x 1 7/8"	5	46A1848
42A2359	7/8" x 2 <sup>5</sup> / <sub>16</sub> "	5	46A2359
42A3068	1 1/16" x 2 <sup>21</sup> / <sub>32</sub> "	7	46A3068
42A4060	1 9/16" x 2 <sup>11</sup> / <sub>32</sub> "	9	46A4060
42A4078	1 9/16" x 3 1/16"	9	46A4078
42A4545	1 5/8" x 1 5/8"	9	46A4545
42A12	1 <sup>5</sup> / <sub>32</sub> " Diameter	3	46A12
42A17	5/8" Diameter	4	46A17
42A43	1 5/8" Diameter	9	46A43
42099	Signature	N/A	46000

## ExcelMark Re-Inking Instructions



### Step 1

Push stamp down & press the red buttons to lock stamp into place.



### Step 2

With the back of the stamp facing you, push the ink pad out.



### Step 3

Grasp the ink pad by the edges, turn it over and re-insert to double the number of impressions.



## Shiny Heavy Duty Self-Inking Stamps

Item #	Impression Area	Max. # of Lines	Replacement Pad
E-900	1 <sup>5</sup> / <sub>16</sub> " x 1 <sup>5</sup> / <sub>8</sub> "	5	46900
E-903	1 <sup>3</sup> / <sub>16</sub> " x 2"	7	46903
E-906	1 <sup>5</sup> / <sub>16</sub> " x 2 <sup>3</sup> / <sub>16</sub> "	9	46906
E-908	1 <sup>7</sup> / <sub>8</sub> " x 2 <sup>5</sup> / <sub>8</sub> "	11	46908



## Shiny Heavy Duty

- Solid metal and plastic frame.
- Designed for ultimate durability.
- Suited for medium to high volume use.

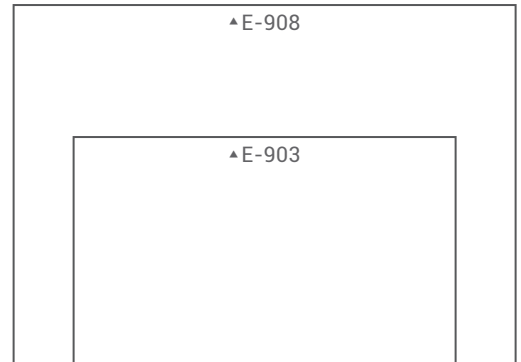
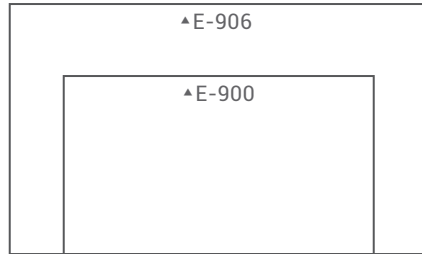

## ANTibac Self-Inking Stamps

Item #	Impression Area	Max. # of Lines	Replacement Pad
42842NT	9/16" x 1 1/2"	3	46842
42843NT	3/4" x 1 7/8"	4	46843
42844NT	7/8" x 2 3/8"	4	46844
42846NT	1 1/16" x 2 9/16"	6	46846



## ANTibac

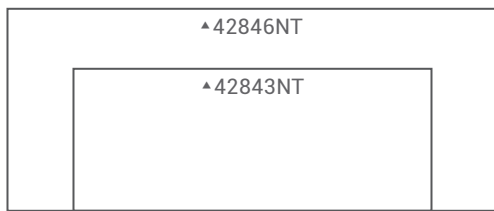

## Shiny Handy Stamps

- Portable yet durable and great when stamping on the go is necessary.
- The unique design makes handling easy as it can be operated with one hand.

### Shiny Handy Self-Inking Stamps

Item #	Impression Area	Max. # of Lines
42Q12	1/2" Diameter	3
42Q17	3/4" Diameter	4
42S722	9/16" x 1 1/2"	3
42S723	3/4" x 1 7/8"	4

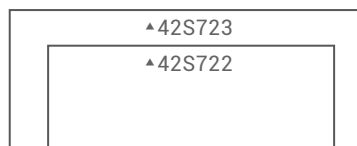

## Rubber Stamps

- Traditional and economical stamp option
- Separate stamp pad required to ink
- Available in a variety of sizes
- Perfect for special ink needs

### Available Colors

- Black ● Red ● Blue
- Green ● Purple ● Brown



43099 | Signature Stamp

*Lauren Meyer*

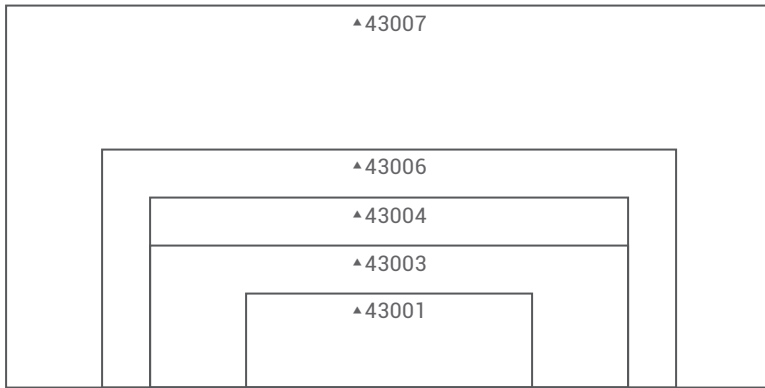

### Rubber Stamps

Item #	Impression Area	Max. # of Lines
43001	1/2" x 1 1/2"	3
43002	3/4" x 2"	4
43003	3/4" x 2 1/2"	4
43004	1" x 2 1/2"	6
43005	1 1/4" x 3"	7
43006	2" x 2"	12
43007	2" x 4"	12
43017	7/16" Diameter	3
43018	3/4" Diameter	4
43012	3" x 4"	18
43013	3 1/2" x 5"	21
43099	Signature	N/A

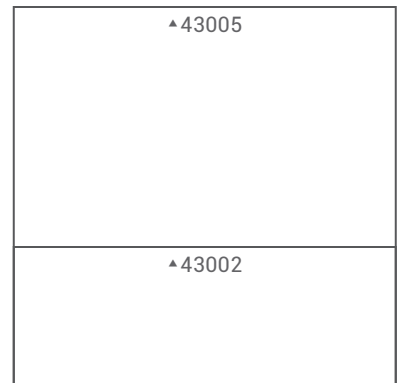
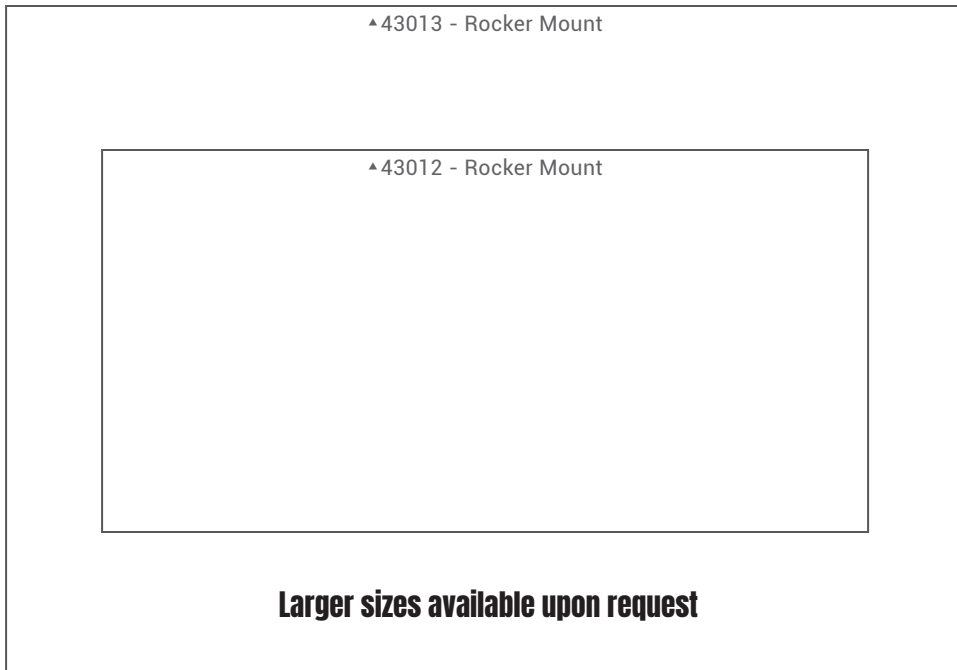

## Custom ExcelMark Self-Inking Date Stamps

Item #	Description	Impression Area	Max. # of Lines	Replacement Pad
42R100	1-Color	1 <sup>5</sup> / <sub>16</sub> " x 1 <sup>11</sup> / <sub>16</sub> "	4	46R100
42R100-2	2-Color	1 <sup>5</sup> / <sub>16</sub> " x 1 <sup>11</sup> / <sub>16</sub> "	4	46R100-2
42R300	1-Color	1 <sup>3</sup> / <sub>16</sub> " x 1 <sup>13</sup> / <sub>16</sub> "	6	46R300
42R300-2	2-Color	1 <sup>3</sup> / <sub>16</sub> " x 1 <sup>13</sup> / <sub>16</sub> "	6	46R300-2
42R600	1-Color	1 <sup>1</sup> / <sub>2</sub> " x 2 <sup>5</sup> / <sub>16</sub> "	6	46R600
42R600-2	2-Color	1 <sup>1</sup> / <sub>2</sub> " x 2 <sup>5</sup> / <sub>16</sub> "	6	46R600-2
42R800	1-Color	1 <sup>7</sup> / <sub>8</sub> " x 2 <sup>11</sup> / <sub>16</sub> "	8	46R800
42R800-2	2-Color	1 <sup>7</sup> / <sub>8</sub> " x 2 <sup>11</sup> / <sub>16</sub> "	8	46R800-2

## ExcelMark

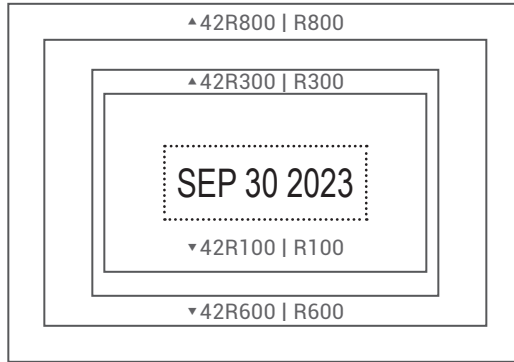

## Self-Inking Daters

- Includes 6 years of date bands
- Thousands of impressions before re-inking is necessary
- Designed for medium to heavy-duty use
- Available in one or two-color impressions

### Date & Custom Message Colors

- Black
- Red
- Blue
- Green
- Purple
- Brown

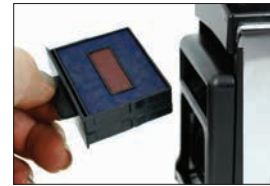

Includes a two-sided ink pad that doubles the number of impressions and the life of the pad.

- Available in two-color impressions.
- Impression Area 1<sup>5</sup>/<sub>16</sub>" x 1<sup>11</sup>/<sub>16</sub>"
- Replacement Pad: 46R100-2



## ExcelMark Stock Message Date Stamps

Actual Size



R100E

### Stock Dater Colors

- Date Color: ● Blue  
Message Color: ● Red



R100P



R100S



R100EM



R100R



R100F

## ExcelMark Re-Inking Instructions



### Step 1

Push stamp down & press red button to lock into place.



### Step 2

Locate ink pad handle at the back of stamp.



### Step 3

Grasp the ink pad by the handle, turn it over and re-insert to double the number of impressions.



## Trodat Professional Daters



- Feature impressions in a variety of types and sizes, and cover a wide range of applications.
- Durable stainless steel body.
- Come with 12 years of bands, and are guaranteed to have 10 current.
- All items are Climate Neutral.



**TEXTS INCLUDED:**

- |                |              |
|----------------|--------------|
| 1. ANSWERED    | 7. CHECKED   |
| 2. BACKORDERED | 8. DELIVERED |
| 3. CANCELLED   | 9. ENTERED   |
| 4. BILLED      | 10. PAID     |
| 5. RECEIVED    | 11. SHIPPED  |
| 6. EMAILED     | 12. FAXED    |

**Trodat Professional Self-Inking Dater**

Item #	Description	Impression Area	Max. # of Lines	Replacement Pad
5030	1-Color / 12 Year Band	1 5/8" x 3/8"		50
5117	Dial-A-Phrase / 1-Color / 12 Year Band	2 1/4" x 3/8"		56
5430	2-Color / 10 Year Band	1" x 1 5/8"	2	50
5440	2-Color / 10 Year Band	1 1/8" x 2"	2	53
5460	2-Color / 10 Year Band	1 5/16" x 2 1/4"	4	56
5474	2-Color / 10 Year Band	1 9/16" x 2 3/8"	6	58
5480	2-Color / 10 Year Band	2" x 2 3/4"	8	58

# Trodat Dater / Stock Message Series



CHECKED 28 NOV 2026

↑ Prints the date plus 12 Stock Messages ↑

### TEXTS INCLUDED:

- |                |              |               |
|----------------|--------------|---------------|
| 1. ANSWERED    | 5. E-MAILED  | 9. SHIPPED    |
| 2. RECEIVED    | 6. PAID      | 10. BILLED    |
| 3. ENTERED     | 7. CANCELLED | 11. DELIVERED |
| 4. BACKORDERED | 8. CHECKED   | 12. FAXED     |



17 NOV. 2026



17 NOV. 2026



17 NOV. 2026



1 NOV. 2026

## Trodat Printy Self-Inking Dater / Stock Message Series

Item #	Description	Impression Area	Max. # of Lines	Replacement Pad
4800	1-Color	1 1/8" x 1 11/16"	1	4911
4813	1-Color	3/8" x 1"	1	4817
4817	Dial-A-Phrase / 1-Color	3/8" x 2"		4817
4820	1-Color	3/8" x 1 1/4"		4911
4850	2-Color	3/8" x 1 5/8"		4850

# Trodat Numberers



- Durable stainless steel body.
- All items are Climate Neutral.

### Additional Characters

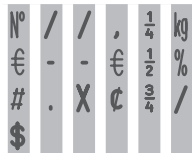

5546

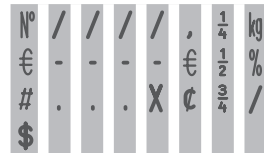

5558



1 2 3 4 5 6



1 2 3 4 5 6 7 8

## Trodat Numberers

Item #	Description	Impression Area	Number of Bands	Replacement Pad
TF5546	Professional Numberer	5/32" Character	6	50
TF5558	Professional Numberer	3/16" Character	8	56

## Trodat Line & Round Daters



- Small and lightweight.
- Easy to change ink cartridges.
- Many are Climate Neutral.
- Come with 12 years of bands, and are guaranteed to have 10 current.



### Trodat Printy Self-Inking Daters

Item #	Description	Impression Area	Max. # of Lines	Replacement Pad
TR43132	2-Color	1 1/4" x 1 1/4"	4	43032
TR46130	2-Color	1 3/16" Diameter	4	46030
TR46140	2-Color	1 5/8" Diameter	6	46040
TR46145	2-Color	1 3/4" Diameter	8	46045
TR4724	2-Color	1 5/8" x 1 5/8"	4	4924
TR4726	2-Color	1 1/2" x 3"	6	4926
TR4727	2-Color	1 9/16" x 2 3/8"	6	4927
TR4729	2-Color	1 3/16" x 2"	4	4929
TR4750	2-Color	1" x 1 5/8"	2	4750

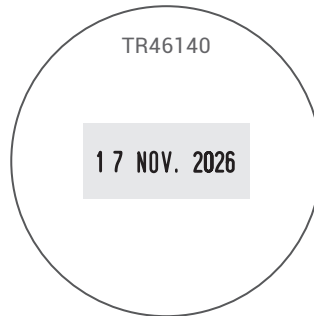
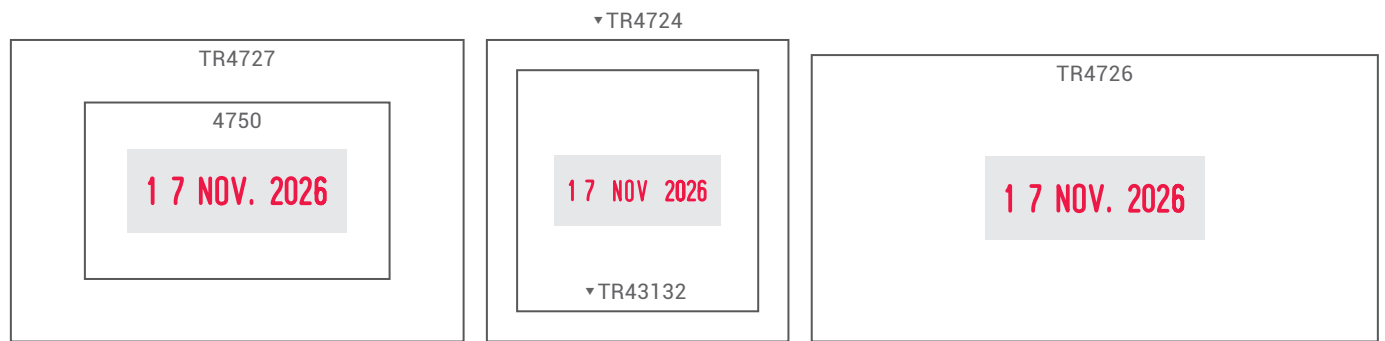

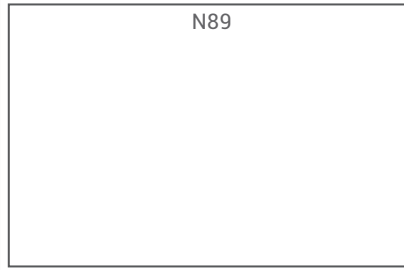
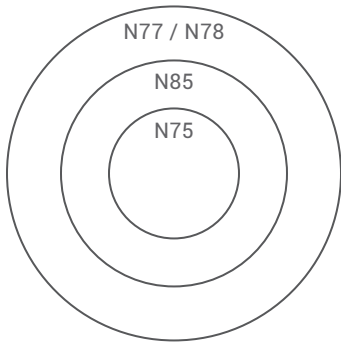

## XpeDater Date Stamps

- Prints your custom message along with the day, month and year over a 6-year period.
- A simple twist of the base and a turn of the dials changes the date.

Item #	Impression Area	Max. # of Lines	MSRP
N75	1 1/16" Diameter	2	\$64.85
N77	1 3/4" Diameter	4	\$95.95
N78	1 3/4" Diameter	4	\$95.95
N85	1 3/16" Diameter	4	\$87.95
N89	1 3/8" x 2 1/8"	8	\$81.80

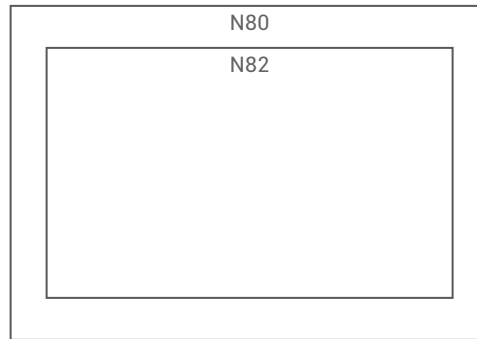

## VersaDater Pre-Inked Date Stamps

- 8-year pre-inked line dater.
- The date is easily changed with a quick turn of the dial.
- When you snap on the pre-inked Impression Frame™, you create a whole new message dater.

Item #	Impression Area	Max. # of Lines	MSRP
N80	1 3/4" x 2 1/2"	8	\$101.60
N82	1 5/16" x 2 1/8"	4	\$90.55



## XStamper Date Stamps

- Heavy duty 8-year date stamp is designed for repetitive impressions.
- Comes with its own 2-color pre-inked base.



Item #	Impression Area	Max. # of Lines	Replacement Base	MSRP
N90	1 3/16" x 1 15/16"	4	66400	\$91.90



## Rubber Daters

- Includes 7 years of date bands
- Used with a separate ink pad
- Includes Paid, Ent'd, Rec'd, A.M., P.M. in place of year

## Local Style Daters



43311 JAN 19 '22

43313 JAN 19 2024

43314 JAN 19 2025

## Line Daters

43301 MAR 26 2022

43302 MAR 26 2022

43303 MAR 26 2022

43304 MAR 26 2022

43305 MAR 26 2022



## Rubber Line Daters

Item #	Model #	Band Size	Character Height	Impression Area	Max. # of Lines
43301	BD0	0	3/32"	1/8" x 13/16"	
43302	BD1	1	1/8"	1/8" x 13/16"	
43303	BD11/2	1 1/2	5/32"	5/32" x 15/16"	
43304	BD2	2	3/16"	3/16" x 1 1/4"	
43311	MLCD1	0	3/32"	11/32" x 7/16"	2
43313	MLD1	1 1/2	5/32"	11/32" x 3/8"	2
43314	MLD3	1 1/2	5/32"	11/32" x 7/8"	2

## Bridge Daters



43320

JUN 12 2023

43321

MAR 19 2024



43322

FEB 12 2023

## Flat Band Daters



JUL 16 2024

43140

43142

43143

43144

## Double Daters



43149

MAY 10 2024 MAY 10 2024

## Rubber Daters

Item #	Model #	Band Size	Character Height	Impression Area	Max. # Of Lines
43320	SBD1 1/4	1 1/2	5/32"	11/32" x 1 1/4"	2
43321	SBD1 1/2	1 1/2	5/32"	11/32" x 1 1/2"	2
43322	DBD1 1/4	1 1/2	5/32"	1 1/4" x 1 1/4"	4
43149	MDD402 3/4	1 1/2	5/32"	1 1/4" x 2 3/4"	4
43140	MD401 1/4	1 1/2	5/32"	1 1/4" x 1 1/4"	4
43142	MD401 1/2	1 1/2	5/32"	1 1/4" x 1 1/2"	4
43143	MD401 3/4	1 1/2	5/32"	1 1/4" x 1 3/4"	4
43144	MD402	2	5/32"	1 1/4" x 2"	4



# Automatic Numbering Machines

- Automatically re-inked by self-contained die
- Re-ink with numbering machine ink only

### Available Colors

● Black ● Red ● Blue

## Rubber Line Daters

Item #	# of Wheels	# of Movements
42740	6	Repeat, 1x, 2x, 3x, 4x, 6x, and 12x
42741	6	Repeat, 1x, 2x, 3x, and 4x
42742	7	Repeat, 1x, 2x, and 3x,
42743	6	Repeat, 1x, 2x, 3x, and 4x
42744	7	Repeat, 1x, 2x, 3x, and 4x

**\*\*Numberers, Alphabet Stamps, and Cost/Selling Stamps are available in various sizes upon request.\*\***

## Standard Numbering Machine

*Ideal for normal everyday use*

42741

394725

42742

1574842



## Deluxe Numbering Machine

*Ideal for a heavy-duty use*

42743

296505

42744

4728852



## Econo Numbering Machine

*Ideal for light-duty application*

42740

568226



## Self-Inking Numberers\*



## Rubber Numberers\*



## Alphabet Stamps, Cost & Selling and Alpha-Numerical Stamps\*\*

## NUMBERERS

Figure bands are available in a variety of sizes and styles, all containing 0-9

Letter bands A-M, N-Z or dates can be inserted into any position for an additional charge

Available in self-inking and rubber styles

Bands are available in Gothic or Roman

Additional brands and styles of Daters + Numberers are available. Contact us for assistance.

# STOCK STAMPS

- Available in your choice of Pre-Inked or Self-Inking stamp style.
- Impressions area: 1/2" x 1 1/2"
- All messages are available in Spanish.



Actual Size  
Pre-Inked: FLS54  
Self-Inking: SS54



Pre-Inked



Self-Inking

Available Colors  
● Red ● Blue

**SCANNED**

Pre-Inked: FLS12  
Self-Inking: SS12

**SECOND REQUEST**

Pre-Inked: FLS26  
Self-Inking: SS26

**SHRED**

Pre-Inked: FLS49  
Self-Inking: SS49

**SIGN HERE** ⇨

Pre-Inked: FLS18  
Self-Inking: SS18

**COPY**

Pre-Inked: FLS30  
Self-Inking: SS30

**DEPOSITED**

Pre-Inked: FLS40  
Self-Inking: SS40

**FOR DEPOSIT ONLY**

Pre-Inked: FLS50  
Self-Inking: SS50

**PAYMENT DUE UPON RECEIPT**

Pre-Inked: FLS1  
Self-Inking: SS1

*Thank You!*

Pre-Inked: FLS13  
Self-Inking: SS13

**CONFIDENTIAL**

Pre-Inked: FLS97  
Self-Inking: SS97

**DRAFT**

Pre-Inked: FLS98  
Self-Inking: SS98

**FYI**

Pre-Inked: FLS48  
Self-Inking: SS48

Please Sign & Return

Pre-Inked: FLS42  
Self-Inking: SS42

**URGENT**

Pre-Inked: FLS43  
Self-Inking: SS43

**CUSTOMER COPY**

Pre-Inked: FLS95  
Self-Inking: SS95

**DUPLICATE**

Pre-Inked: FLS21  
Self-Inking: SS21

**MAILED**

Pre-Inked: FLS20  
Self-Inking: SS20

**PERSONAL AND CONFIDENTIAL**

Pre-Inked: FLS82  
Self-Inking: SS82

**VOID**

Pre-Inked: FLS27  
Self-Inking: SS27

**COMPLETED**

Pre-Inked: FLS80  
Self-Inking: SS80

**EMAILED**

Pre-Inked: FLS102S  
Self-Inking: SS102

**MOBILE DEPOSIT**

Pre-Inked: FLS37  
Self-Inking: SS37

**POSTED**

Pre-Inked: FLS25  
Self-Inking: SS25

**CANCELLED**

Pre-Inked: FLS41  
Self-Inking: SS41

**CLIENT'S COPY**

Pre-Inked: FLS39  
Self-Inking: SS39

**ENTERED**

Pre-Inked: FLS6  
Self-Inking: SS6

**ORIGINAL**

Pre-Inked: FLS59  
Self-Inking: SS59

**RECEIVED**

Pre-Inked: FLS4  
Self-Inking: SS4

**REVISED**

Pre-Inked: FLS22  
Self-Inking: SS11

**RUSH!**

Pre-Inked: FLS10  
Self-Inking: SS10

**FAXED**

Pre-Inked: FLS3S  
Self-Inking: SS3

**PAID**

Pre-Inked: FLS2  
Self-Inking: SS2

**Past Due**

Pre-Inked: FLS15  
Self-Inking: SS15

**FILE COPY**

Pre-Inked: FLS32  
Self-Inking: SS32

Additional Stock Stamps are available at  
[www.schwaab.com](http://www.schwaab.com)

# LARGE STOCK STAMPS



- Available in Pre-Inked Stamp Style.
- Impression area: 3/4" x 2 1/2"

Actual Size



Pre-Inked: FLS102

### Available Colors

- Red
- Blue



Pre-Inked: FLS5



Pre-Inked: FLS3



Pre-Inked: FLS7



Pre-Inked: FLS4

**Thank You**

Your Business is Appreciated and We Hope to Serve You Again.

Pre-Inked: FLS89

42512 | S-304

APPROVED

\$6.10

E-MAILED  
FAXED  
FILED  
PAID  
PAST DUE  
SCANNED

APPROVED  
CANCELLED  
CONFIDENTIAL  
CONFIRMATION  
COPY  
FILE COPY

42518 | S-414

APPROVED

\$6.75

AIR MAIL  
APPROVED  
CANCELLED  
CONFIDENTIAL  
CONFIRMATION  
COPY

CHECKED  
FILE COPY  
FIRST CLASS  
CREDIT  
OVERDUE  
URGENT!



# PLASTIC STOCK MESSAGE STAMP

- Available in Self-Inking Stamp Style.
- Includes 12 stock message in two sizes.

### Available Colors

- Black
- Red
- Blue



# MINI STOCK STAMP

- Available in Pre-Inked Stamp Style.
- Impression area: 1/2" diameter

### Available Colors

- Red
- Blue



MS7



MS17



MS12



MS14



MS16



MS15



MS3



MS9



MS2



MS25



MS13



MS10



MS1

# IDENTITY THEFT GUARD STAMPS Effectively used to hide confidential information to help prevent identity theft.

## Rolling Identity Theft Guard Stamp

- Part # ID-ROLLER
- Impression Area: 1 1/2" x up to 100 meters in length.
- To use, simply open the cover and start swiping.
- Reinkable for unlimited use.



## Identity Theft Guard Stamp

- Part # 42020-SEC
- Dimensions: 9/16" x 1 1/2"
- Self-Inking stamp designed with a special pattern to hide confidential information printed beneath.
- Ideal for use on junk mail, or anything containing personal information.



Stamp Pattern



# Stamp Replacement Pads

ITEM	DESCRIPTION	DIMENSIONS
<b>Self-Inking Stamp Replacement Pads</b>		
<b>ExcelMark</b>		
<i>Set of 2 (Double-Sided) - Indicate Color</i>		
46A1226	ExcelMark A1226	1 <sup>5</sup> / <sub>32</sub> " x 1"
46A1539	ExcelMark A1539	9 <sup>1</sup> / <sub>16</sub> " x 1 1/2"
46A1848	ExcelMark A1848	1 <sup>1</sup> / <sub>16</sub> " x 1 7/8"
46A2359	ExcelMark A2359	7/8" x 2 5/16"
46A1776	ExcelMark A1776	5/8" x 2 21/32"
46A3068	ExcelMark A3068	1 1/16" x 2 21/32"
46A4060	ExcelMark A4060	1 9/16" x 2 11/32"
46A4078	ExcelMark A4078	1 9/16" x 3 1/16"
46A12	ExcelMark A12	1 5/32" Diameter
46A17	ExcelMark A17	5/8" Diameter
46A43	ExcelMark A43	1 5/8" Diameter
<i>Set of 3 - Indicate Color</i>		
46TX11	ExcelMark 9011	1/2" x 1 1/2"

## Shiny Ecoline PET & Antibac

*1-Color Replacement Pads (Set of 3 - Indicate Color)*

46842	Shiny 842	9/16" x 1 1/2"
46843	Shiny 843	3/4" x 1 7/8"
46844	Shiny 844	7/8" x 2 3/8"
46846	Shiny 846	1 1/16" x 2 9/16"

*2-Color Replacement Pads (Set of 3 - Indicate Color)*

46842A	Shiny 842 - 2 Color Horizontal	9/16" x 1 1/2"
46842B	Shiny 842 - 2 Color Vertical	9/16" x 1 1/2"
46843A	Shiny 843 - 2 Color Horizontal	3/4" x 1 7/8"
46843B	Shiny 843 - 2 Color Vertical	3/4" x 1 7/8"
46844A	Shiny 844 - 2 Color Horizontal	7/8" x 2 3/8"
46844B	Shiny 844 - 2 Color Vertical	7/8" x 2 3/8"

*Set of 3 - Indicate Color*

46010	Max Stamp SI-5200	5/16" x 1 3/16"
46011	2000 Plus Printer 10	3/8" x 1 1/16"
46015	2000 Plus Printer 15	3/8" x 2 3/4"
46020	Max Stamp SI-10 & Printer 20	9/16" x 1 1/2"
46025	Max Stamp SI-25 & Printer 25	5/8" x 3"
46030	Max Stamp SI-20 & Printer 30	3/4" x 1 15/16"
46040	Max Stamp SI-30	1 5/16" x 2 3/8"
46050	Max Stamp SI-35 & Printer 50	1 1/8" x 2 3/4"
46055	Max Stamp SI-50	1 9/16" x 2 3/8"
46060	Max Stamp SI-40	1 1/2" x 3"
46061	2000 Plus Printer 40	1 5/16" x 2 3/8"
46062	2000 Plus Printer 45	1" x 3 1/4"
46063	2000 Plus Printer 55	1 3/8" x 2 3/8"
46064	2000 Plus Printer 60	1 1/2" x 3"
46012	Max Stamp C-12 & Printer R-12	1/2" Diameter
46017	Max Stamp C-17 & Printer R-17	1 1/16" Diameter
46150	Max Stamp C-43	1 5/8" Diameter
46065	2000 Plus Printer R-40	1 5/8" Diameter

## Heavy Duty Self-Inking Stamp

### Replacement Pads

*Set of 3 - Indicate Color*

46001	PSI M100P & 2000 Plus 2100	1 5/16" x 1 11/16"
46002	PSI M300 P & 2000 Plus 2300	1 3/16" x 1 13/16"
46003	PSI M600P & 2000 Plus 2600	1 1/2" x 2 5/16"
46004	PSI M800P & 2000 Plus 2800	1 7/8" x 2 11/16"
46900	Replacement Pads E900	5/16" x 1 11/16"
46903	Replacement Pads E903	1 3/16" x 1 13/16"
46906	Replacement Pads E906	1 1/2" x 2 5/16"
46908	Replacement Pads E908	1 7/8" x 2 11/16"

# Dater Replacement Pads

ITEM	DESCRIPTION	DIMENSIONS
<b>Self-Inking Dater Replacement Pads</b>		
<b>ExcelMark M Series</b>		
<i>1-Color Replacement Pads (Set of 2 Double-Sided - Indicate Color)</i>		
46R100	ExcelMark R100	1 5/16" x 1 11/16"
46R300	ExcelMark R300	1 3/16" x 1 13/16"
46R600	ExcelMark R600	1 1/2" x 2 5/16"
46R800	ExcelMark R800	1 7/8" x 2 11/16"
<i>2-Color Replacement Pads (Set of 3 - Indicate Color)</i>		
46R100-2	ExcelMark R100	1 5/16" x 1 11/16"
46R300-2	ExcelMark R300	1 3/16" x 1 13/16"
46R600-2	ExcelMark R600	1 1/2" x 2 5/16"
46R800-2	ExcelMark R800	1 7/8" x 2 11/16"

## MaxStamp Eco-Series

*1-Color Replacement Pads (Set of 3 - Indicate Color)*

46261	Max Stamp ECO-261	1 5/16" x 1 3/4"
46300	Max Stamp ECO-300	1 3/16" x 1 13/16"
46600	Max Stamp ECO-600	1 1/2" x 2 5/16"
46800	Max Stamp ECO-800	1 7/8" x 2 11/16"

*2-Color Replacement Pads (Set of 3 - Indicate Color)*

46261-2	Max Stamp ECO-261	1 5/16" x 1 3/4"
46300-2	Max Stamp ECO-300	1 3/16" x 1 13/16"
46600-2	Max Stamp ECO-600	1 1/2" x 2 5/16"
46800-2	Max Stamp ECO-800	1 7/8" x 2 11/16"

## PSI M Series & 2000 Plus

*1-Color Replacement Pads (Set of 3 - Indicate Color)*

46005	PSI 301-1/4	Line Dater Only
46160	PSI M100 & 2000 Plus 2160	1 5/16" x 1 11/16"
46360	PSI M300 & 2000 Plus 2360	1 3/16" x 1 13/16"
46660	PSI M600 & 2000 Plus 2660	1 1/2" x 2 5/16"
46860	PSI M800 & 2000 Plus 2860	1 7/8" x 2 11/16"
46161	PSI M9950D	1 3/4" Diameter
46155	5220 & 5220P Micro Daters	1/4" x 1"
46165	2000 Plus SDS140	1/8" x 1 5/8"
46140	C43D	1 5/8" Diameter
46154	C50D	2" Diameter

*Set of 3 - Indicate Color*

46160-2	PSI M100 & 2000 Plus 2160	1 5/16" x 1 11/16"
46360-2	PSI M300 & 2000 Plus 2360	1 3/16" x 1 13/16"
46660-2	PSI M600 & 2000 Plus 2860	1 1/2" x 2 5/16"
46860-2	PSI M800 & 2000 Plus 2860	1 7/8" x 2 11/16"
46665-2	PSI M9950D	1 3/4" Diameter
46155-2	5220 & 5220P Micro Daters	1/4" x 1"
46140-2	C43D	1 5/8" Diameter
46154-2	C50D	2" Diameter

## Shiny Plastic Dater Units

46510	Shiny S-300 Dater	Line Dater Only
46511	Shiny S-303 Dater	3/16" x 1"
46516	Shiny S-400 Dater	Line Dater Only
46514	Shiny S-312 Dater	1/8" x 1 1/2"
46513	Shiny S-309 Numberer	1/8" x 1/2"
46515	Shiny S-313 Numberer	1/8" x 2"
46517	Shiny S-409 Numberer	3/16" x 7/8"

## All Other Units

46000-3C	Contact Home Office
----------	---------------------

# Marking Inks

ITEM	APPLICATION	CHARACTERISTICS	RECOMMENDED SURFACES	INCOMPATIBLE SURFACES	DRYING TIME	INK COLORS	SIZE	ITEM #
ExcelMark Premium Stamp Ink	Self Inking Stamps, Self Inking Daters & Rubber Stamp Pads	High performance, water-based stamp ink.	Porous surfaces including non-coated paper.	Fabric, Glossy Paper, Wood, Plastics, Glass, Metal, Photos	Moderate	● Black ● Red ● Blue ● Green ● Purple ● Brown	5 cc 2 oz.	42201 42202
ExcelMark Flash Ink	Flash Stamps & Flash Daters	High performance, oil-based stamp ink.	Porous surfaces including non-coated paper.	Fabric, Glossy Paper, Wood, Plastics, Glass, Metal, Photos	Moderate	● Black ● Red ● Blue ● Green	1/4 oz.	51098
Xstamper Ink	Xstamper Stamps & Daters	High performance, oil-based stamp ink.	Porous surfaces including non-coated paper.	Fabric, Glossy Paper, Wood, Plastics, Glass, Metal, Photos	Moderate	● Black ● Red ● Blue ● Green ● Purple	10 ml 20 ml	50111 50112
Aero Mark II Ink	Use with a red rubber stamp, Aero Mark II Pad and Aero Ink Reactivator	Excellent all purpose, waterproof solvent ink that performs well in all types of application methods.	Porous, non-porous glossy paper, painted surfaces, metal, wood, electronics, plastic, glass, mylar, vinyl, photos.	N/A	Very Fast	● Black ● Red ● Blue ● Green ● Purple	4 oz 8 oz Pint Quart Gallon	43208 43206 42209 42210 42211
Aero Ink Reactivator	Use with Aero Mark II Ink and Pad	Used as a cleaner and thinner for Mark II inks. Reactivates ink pad to extend use. Clean built-up residue on stamp dies.	N/A	N/A	N/A	N/A	4 oz 8 oz Pint Quart	43209 43205 42212 42213
Numbering Machine Ink	Use with automatic numbering machines with metal wheels	N/A	Porous surfaces, fabric, wood.	Non-porous, Coatings, Wood, Plastic, Glass, Metal, Photos	Very Fast	● Black ● Red	1 oz	42204
Invisible Ink	Rubber stamp and felt pad	Invisible unless exposed to ultra-black light.	Porous surfaces, skin, fabric.	Glossy Paper, Wood, Plastics, Glass, Metal, Photos		○ Clear	2 oz 8 oz Pint	42227 42228 42229
Aero Indelible Ink	Rubber stamp, Aero Mark II Pad, felt pad	Ideal for fabric and clothing and resists wet and dry cleaning.	Fabric and clothing, porous & non-porous surfaces.	N/A	Fast	● Black ● Red ● Blue ● Green ● Purple ○ White ● Yellow	2 oz 8 oz Pint	42230 42231 42232

# Ink Pads

ITEM	DESCRIPTION	INK COLORS	SIZE	ITEM #	NO.
Rubber Stamp Felt Pad	For traditional rubber stamp. Also available dry upon request	● Black ● Red ● Blue ● Green ● Purple ● Brown	2 1/8" x 3 1/4" 2 5/8" x 4 1/4" 4 1/4" x 7 1/4"	43201 43202 43204	No. 0 No. 1 No. 3
Mark II Pads	Used with Aero II Mark for stamping. Unique reversible pad allows you to flip the pad over when the ink runs dry. Also available dry upon request	● Black ● Red ● Blue ● Green	2 1/2" x 4 1/2"	43207	N/A
Industrial Pads	Rugged, High-grade dry pads designed for rigorous use and for extra large rubber stamp applications	N/A	5" x 7" 2 3/4" x 4 3/8"	43219 43226	4F 3F

## NOTARY STAMPS & EMBOSSERS



**Notary stamps and embosser meet the strict requirements of each state, and are available in a variety of sizes.**

Item #	Description
51102	Pre-Inked Notary Stamp (Rectangle or Circle Imprint)
42098	Self-Inking Notary Stamp (Rectangle or Circle Imprint)
43098	Rubber Notary Stamp (Rectangle or Circle Imprint)
FL50	SuperSlim Notary Stamp (Rectangle or Circle Imprint)
EM001	Pocket Embosser - Circle
EM003	Pocket Embosser - Rectangle
ED001	Desk Embosser - Circle
ED003	Desk Embosser - Rectangle

## NOTARY SUPPLIES

**Choose from a variety of exceptional notary supplies to save time, provide security and keep accurate records.**

Item #	Description
47003	Standard Notary Journal
NJ5000	Premium Notary Journal
43211	Inkless Thumbprint Pad

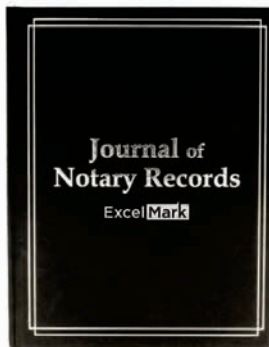

NJ5000

- 100 pages to accommodate 300 entries.
- Includes instructional page for journal entry forms.
- Well-bound hardcover.

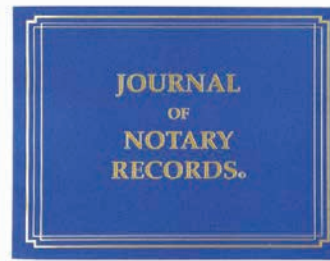

47003

- Journal includes 142 pages to accommodate 639 entries.

43211

- Create a thumbprint without ink, setup, or cleanup. The ink rubs off fingers and won't stain skin. Best of all, it will work on almost any paper.



## NOTARY BUNDLES



Item #	Description
49030	Essential Notary Kit Includes Notary Stamp or Embosser & Standard Notary Journal
49031	Deluxe Notary Kit Includes Notary Stamp & Pocket Embosser
49032	Premium Notary Kit Includes Notary Stamp, Pocket Embosser & Standard Notary Journal

# NOTARY STAMP COLLECTION

Commission Expiration

- Available in Self-Inking or Pre-Inked Stamp.

## Available Colors

- Black
- Red
- Blue
- Green
- Purple
- Brown

**MY COMMISSION EXPIRES  
APRIL 12, 2021**

### Jurat/Affidavit | JUR

State of \_\_\_\_\_  
 County of \_\_\_\_\_  
 Subscribed and sworn to before me this \_\_\_\_\_ day of \_\_\_\_\_, \_\_\_\_\_  
 \_\_\_\_\_, Notary Public  
 My Commission Expires \_\_\_\_\_

### Acknowledgment | ACK

State of \_\_\_\_\_  
 County of \_\_\_\_\_  
 The foregoing document was acknowledged before me this \_\_\_\_\_ day of \_\_\_\_\_, \_\_\_\_\_  
 \_\_\_\_\_, Notary Public  
 My Commission Expires \_\_\_\_\_

### Certified/True Copy | CERT

State of \_\_\_\_\_  
 County of \_\_\_\_\_  
 I certify this to be a complete, exact and true copy of the original document. Certified this \_\_\_\_\_ day of \_\_\_\_\_, \_\_\_\_\_  
 \_\_\_\_\_, Notary Public  
 My Commission Expires \_\_\_\_\_

# NOTARY BONDS AND E&O INSURANCE



## Notary Bonds

Notary bonds are available for every state that requires notaries to purchase a bond for the duration of their commissions. Notary bonds protect the general public against financial loss due to a mistake or an improper or negligent act performed by the notary. Notary bonds offer no insurance protection to the notary.

## Error & Omissions Insurance

Notary E & O Insurance protects the notary's assets in the event a mistake is made during the notarial process that causes your client to suffer financial loss.

**Please contact Customer Service for assistance.**

# NOTARY HANDBOOKS

**We offer the required training for notaries in CA, CO, FL, NY, OR and PA in addition to effective materials for notaries in every state.**

Item #	Description
NOTARY-STUDYCOURSE	The Complete How-To Guide for Notaries
PRIMER	U.S. Notary Law Primer - National Version
NNA-KEESING-GUIDE	I.D. Checking Guide, U.S. & Canada Edition 2022
NOTARY-NO-CAN-DO	The Notary Answer Book
101-NOTARY-TIPS	101 Useful Notary Tips
5-STEPS-GUIDE	5 Steps to a Flawless Notarization

NOTARY-STUDYCOURSE

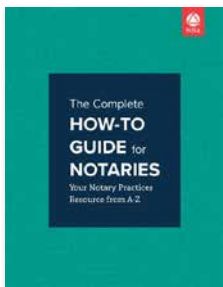

PRIMER



NNA-KEESING-GUIDE

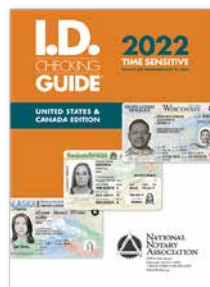

NOTARY-NO-CAN-DO

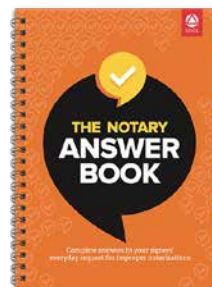

101-NOTARY-TIPS



5-STEPS-GUIDE



## PROFESSIONAL STAMPS

Professional stamps are available in a variety of stamp and embosser styles to meet your specific requirements.

### Corporate Seals

Authenticate your company documents with corporate seals from Schwaab, available in a variety of styles.

### Engineer and Architect Stamps + Seals

Schwaab has Engineer, Architect and other professional stamp and embosser requirements for all 50 states in a variety of styles.



Item #	Description
51104	Pre-Inked Engineer & Architect Stamp
42097	Self-Inking Engineer & Architect Stamp
43097	Rubber Engineer & Architect Stamp
51196	Pre-Inked Corporate Stamp
42096	Self-Inking Corporate Stamp
43096	Rubber Corporate Stamp

## PROFESSIONAL KITS

Corporate Kits allow you to organize and protect all of your important company information.

- Corporate Seal in a pocket embosser with vinyl carrying case.
- Black, vinyl finish 3-ring binder.
- Bound stock transfer ledger or membership rolls where applicable.
- 20 custom imprinted green stock certificates.
- Optional printed minutes & bylaws.
- 20 matching stub sheets.



### Plain Corporate Kits

Contain (20) Blank Certificates, Company Seal, Blank Minute Book Pages, and a Transfer Ledger - all in a 3-Ring Binder with Slip Case

### Standard Kits

as above, but with Custom Imprinted Certificates

### Premium Kits

as above, but with Printed Minutes and Bylaws

Item #	Description
CK-01	Plain Corporate Kit
CK-02	Standard Corporate Kit Printed
CK-03	Premium Corporate Kit
CK-04	Plain Non-Profit Corporate Kit
CK-05	Standard Non-Profit Corporate Kit
CK-06	Premium Non-Profit Corporate Kit
CK-07	Plain LLC & PLLC Kits
CK-08	Standard LLC & PLLC Kit Printed
CK-09	Premium LLC & PLLC Corporate Kit
CK-10	General Corporation Printed Minutes & Bylaws
CK-11	LLC Printed Minutes & Bylaws
CK-12	Non-Profit Corporation Printed Minutes & Bylaws





ED001 | ED002 | ED003

## EZ SEAL DESK EMBOSSE

- Stationary model

Item #	Description	Dimensions
ED001	EZ Seal Desk Seal Embosser	1 5/8" Diameter
ED002	EZ Seal Desk Seal Embosser	2" Diameter
ED003	EZ Seal Desk Seal Embosser	1" x 2"

## EZ SEAL HAND HELD EMBOSSE

- Perfect for carrying with you and storing in small spaces.

Item #	Description	Dimensions
EM001	EZ Seal Pocket Embosser	1 5/8" Diameter
EM002	EZ Seal Pocket Embosser	2" Diameter
EM003	EZ Seal Pocket Embosser	1" x 2"



EM001 | EM002 | EM003



EH004 | EH002

## LONG REACH EMBOSSE

- Designed for heavy duty usage.
- Includes an extra-long handle for 2 1/2" reach.

Item #	Description	Dimensions
44011	Long Reach Desk Embosser	1 3/4" Diameter
44012	Long Reach Desk Embosser	2" Diameter

## GIFT EMBOSSE

- Premium embossers that add a touch of elegance.
- Includes a felt base to ensure no slipping during use.
- Excellent gift idea.

Item #	Description	Dimensions
44004GG	Gold Gift Embosser	1 5/8" Diameter
44006GG	Gold Gift Embosser	1" x 2"
44004CG	Silver Gift Embosser	1 5/8" Diameter
44006CG	Silver Gift Embosser	1" x 2"

44004GG | 44006GG



44004CG | 44006CG



49021

## SEAL INKER

- Used to make seal impressions suitable for photocopying or faxing.

### Available Color

- Black



49020

## GOLD FOIL SEALS

- Emboss an image on a gold foil seal to add a touch of class and professionalism to your documents.
- 40 seals per package.

## CLASSIC ENGRAVED BADGES

- Engraved plastic name badges with beveled edges to provide a distinctive appearance.
- Please see Page 48 for Plastic Color Choices.

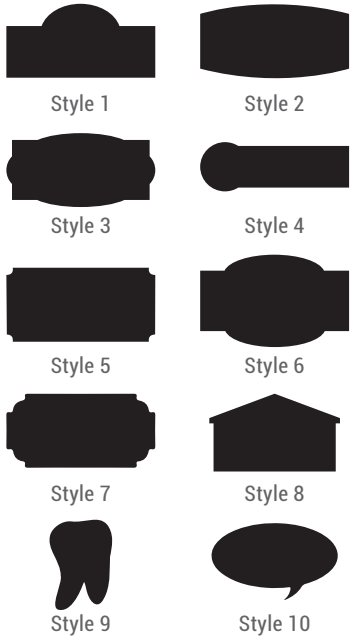

**Create your own custom shape or choose from one of our stock shapes.**

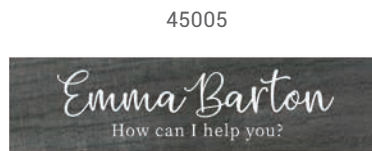
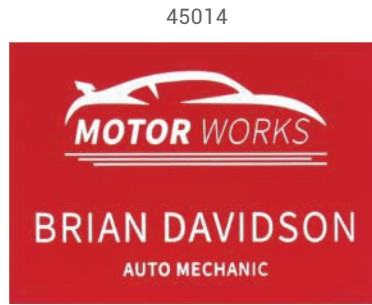
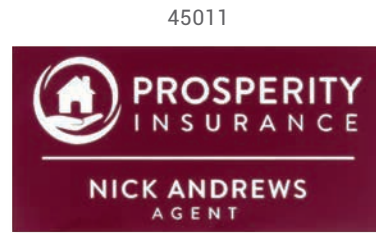

Item #	Size	Max. # of Lines
45005	¾" x 3"	2
45008	1" x 3"	3
45157	1¼" x 3"	3
45011	1½" x 3"	3
45014	2" x 3"	4
45019	1¾" x 2½" (Oval)	3
45133	1-5 Square Inches	4
45135	Stock/Custom Shape. Call for Pricing.	

## DESIGNER ENGRAVED BADGES

- Engraved plastic name badges applied to a silver or gold carrier to bring a premium appearance to any attire.
- Please see Page 48 for Plastic Color Choices.



Item #	Faceplate Size	Carrier Size	Max. # of Lines
45008D	1 <sup>3</sup> / <sub>16</sub> " x 2 <sup>13</sup> / <sub>16</sub> "	1" x 3"	3
45011D	1¼" x 2¾"	1½" x 3"	3
45019D	1 <sup>9</sup> / <sub>16</sub> " x 2 <sup>7</sup> / <sub>16</sub> " (Oval)	1 <sup>11</sup> / <sub>16</sub> " x 2 <sup>9</sup> / <sub>16</sub> " (Oval)	3

### Badge Carrier Colors



## FULL COLOR PLASTIC BADGES

- Dynamic name badges, digitally printed in any colors.
- On your choice of white, silver, or gold plastic.

45116P



### Badge Colors

● Gold ● Silver ○ White

Item #	Size	Max. # of Lines
45113P	1" x 3"	3
45114P	1½" x 3"	3
45115P	2" x 3"	4
45116P	1¾" x 2½" (Oval)	3
45134	1-5 Square Inches	4
49004	One time set up Charge. Call for Pricing.	

45114P



45115P



45113P



**Premium Shapes:**  
Create your own custom shape or choose from one of our stock shapes.

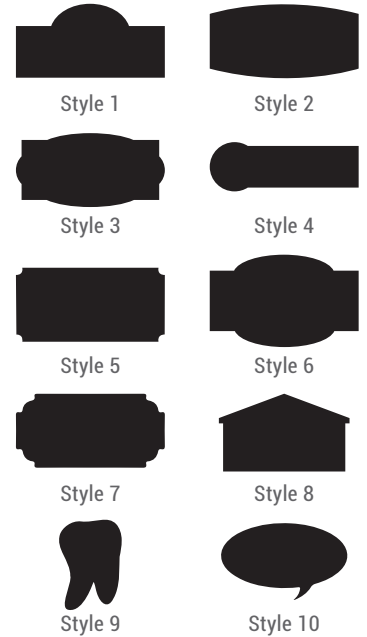

45135 Custom Shape



## FULL COLOR ALUMINUM BADGES

- Vibrant name badges digitally printed in any colors.
- On your choice of white, silver, or gold Aluminum.

45115A



### Aluminum Badge Colors

● Gold ● Silver ○ White

45113A



45114A



Item #	Size
45113A	1" x 3"
45114A	1½" x 3"
45115A	2" x 3"

**A one time art charge is applied if production ready art is not supplied. Contact us for volume discount pricing.**

## DESIGNER FULL COLOR BADGES

- Aesthetically appealing full color badges with metal faceplate and badge carrier.
- Any imprint color is available.

Item #	Faceplate Size	Carrier Size	Max. # of Lines
45008F	1 <sup>3</sup> / <sub>16</sub> " x 2 <sup>13</sup> / <sub>16</sub> "	1" x 3"	3
45011F	1" x 3"	1 <sup>1</sup> / <sub>4</sub> " x 3 <sup>1</sup> / <sub>4</sub> "	3
45019F	1 <sup>9</sup> / <sub>16</sub> " x 2 <sup>7</sup> / <sub>16</sub> "	2 <sup>11</sup> / <sub>16</sub> " x 1 <sup>15</sup> / <sub>16</sub> "	4
45098F	1 <sup>7</sup> / <sub>16</sub> " x 2 <sup>13</sup> / <sub>16</sub> "	1 <sup>5</sup> / <sub>8</sub> " x 3"	3

### Faceplate Colors



### Badge Carrier Colors



## POCKET BADGES

- Pocket badges are heat folded to slip over a pocket and stay in place.
- Available in engraved or digitally printed.
- Please see Page 48 for Plastic Color Choices.

Item #	Faceplate Size
45139	1" x 3"
45140	1 <sup>1</sup> / <sub>2</sub> " x 3"
45141	2" x 3"

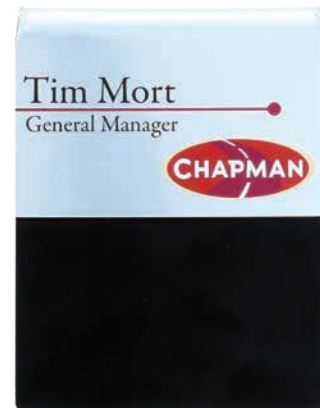

## REUSABLE WINDOW BADGES

- Full color 2-ply plastic name badge.
- Includes paper inserts.
- Ideal for seasonal business or industries with high turn-over.
- Please see Page 48 for Plastic Color Choices.

Item #	Size
45145	2" x 3"



**A one time art charge is applied if production ready art is not supplied. Contact us for volume discount pricing.**

# REUSABLE MESSAGE BADGES

- Available in chalkboard or dry erase styles!
- Customize with a full color logo or text, or order blank and write in your own customization.
- Lightweight and easy to use.

## Chalkboard

Designed for use with standard chalk.



45135 Custom Shape

## Dry Erase

Designed for use with standard dry erase markers

45153

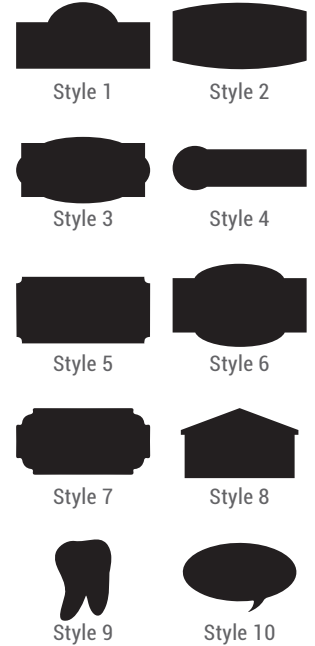

Item #	Size
45146	1" x 3"
45147	1½" x 3"
45148	2" x 3"
45149	1-5 Square Inches

\*Deduct 40% for blank badges.

### Available Colors

● Black ○ White ● Pine Green

Item #	Size
45150	1" x 3"
45151	1½" x 3"
45153	2" x 3"
45154	1-5 Square Inches

\*Deduct 40% for blank badges.

### Available Colors

● Black ○ White

**Create your own custom shape or choose from one of our stock shapes.**

# PHOTO ID BADGES

- Full color badge digitally printed on white plastic and includes a photo.
- Slot punches available on request.

Item #	Faceplate Size
45138	2" x 3"

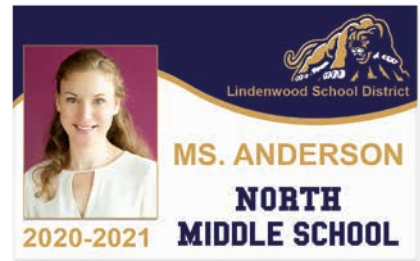

# BADGE ACCESSORIES

Item #	Description
45101	Pin
45102	Clip
45103	Magnet
45104	Pocket Holder
45107	Plastic Card Holder
45108	Card Holder
45106	Lanyard
45109	Bull Dog Straps
45110	Retractable Badge Reel



# Nameplate Inserts

Step 1: Choose an insert material and imprint preference from the below options.

## CLASSIC ENGRAVED



- Professionally engraved plastic nameplates available in a variety of color combinations.



### Insert Colors

Please see Page 48 for Insert Colors.

Item #	Size
45020	2" x 8"
45021	2" x 10"

## FULL COLOR

- Digitally printed plastic nameplates ideal for logos and graphics.

### Nameplate Colors

● Gold ● Silver ○ White

Item #	Size
45290	2" x 8"
45293	2" x 10"



## BRASS & ALUMINUM

- Engraved aluminum and brass nameplates for a distinctive appearance.
- Choose from engraved or engraved with black oxidization.

Item #	Description	Size
NPAL8	Aluminum	2" x 8"
NPAL10	Aluminum	2" x 10"
NPBR8	Brass	2" x 8"
NPBR10	Brass	2" x 10"
NPBG8	Black/Gold Brass	2" x 8"
NPBG10	Black/Gold Brass	2" x 10"

Wall Fasteners



STICKY TAPE  
Item: 45124



SCREWS (2)  
Item: 45125



FOAM TAPE  
Item: 45131



VELCRO  
Item: 45120

# Nameplate Holders

Step 2: Now choose your optional holder from the many styles shown below.

## ALUMINUM WALL HOLDERS

Item #	Style	Corner	Size
45211	Wall	Square	2" x 8"
45036	Wall	Square	2" x 8"
45037	Wall	Square	2" x 10"

Profile



● Gold

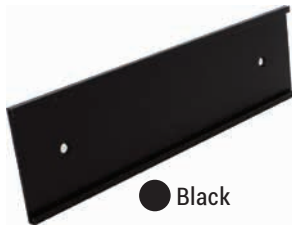

● Black

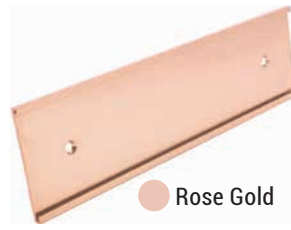

● Rose Gold



● Silver

## ALUMINUM DESK HOLDERS

Item #	Style	Corner	Size
45210	Desk	Square	1" x 8"
45034	Desk	Square	2" x 8"
45035	Desk	Square	2" x 10"

Profile



● Gold



● Black

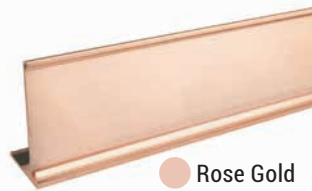

● Rose Gold



● Silver

## PLASTIC WALL HOLDERS

Item #	Style	Corner	Size
PP8S	Wall	Square	2" x 8"
PP8R	Wall	Round	2" x 8"
PP10S	Wall	Square	2" x 10"
PP10R	Wall	Round	2" x 10"



● Desert Sand



● Black

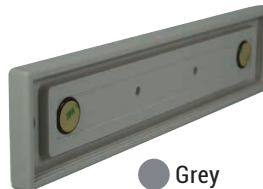

● Grey



● Brown

## PLASTIC BASE HOLDERS

Item #	Style	Corner	Size
PB8	Base	Square	2" x 8"
PB8-BLK	Base	Square	2" x 8"
PB10	Base	Square	2" x 10"
PB10-BLK	Base	Square	2" x 10"



○ Clear



● Black

## BLACK PLASTIC DESK BAR

\*Shown with sample inserts

Item #	Style	Corner	Size
DBS	Desk	Square	1 3/4" x 9 1/8"
DBR	Desk	Round	1 3/4" x 9 1/8"



SUCTION CUP (1)  
Item: 45130



FABRIC PINS (2)  
Item: 45121



MAGNETIC TAPE  
Item: 45122



SM PLASTIC HANGER  
Item: 45123  
3 1/2" L, 2 1/8" D, 1 7/8" H



LG PLASTIC HANGER  
Item: 45126  
6" L, 3" D, 2 1/4" H

# Designer Wood and Glass Desk Nameplates

## SANDBLASTED GLASS

- Glass nameplate with sandblasted customization and a modern chrome holder.

Item #

Size

45401

3" x 10"



## PIANO FINISH DESK WEDGE

- Finishing Options: Black/Gold Aluminum Insert or Engraved and Color Filled.

Item #	Finish	Length	Plate Size
45362	Rosewood	8½"	2" x 8"
45358	Rosewood	10½"	2" x 10"
45360	Piano Black	8½"	2" x 8"
45361	Piano Black	10½"	2" x 10"

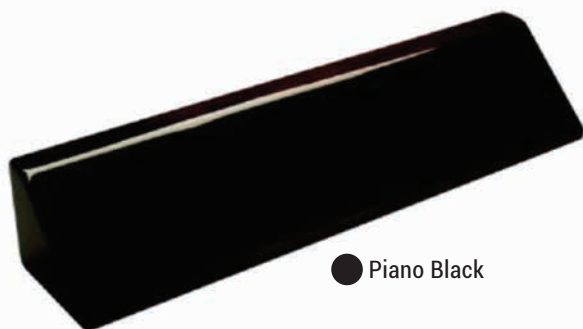

● Piano Black



● Rosewood

## WALNUT DESK WEDGE



- Finishing Options: Brass Insert

Item #

Length

Plate Size

45332

8½"

2" x 8"

45334

10½"

2" x 10"



# Designer Acrylic Desk Nameplates

## ACRYLIC NAMEPLATE

- Item: ACBNP
- Size: 2½" x 8" x 1⅛"

Choose from one of our designs or customize your own by adding a company logo, background or image.



Orchids



Golf Course



Palette



Marble Clear



Black Granite



Leopard



Floral Purple



Zebra Stripes



Gold Granite



Clear



Tropical in Navy



Floral Pink



Golf Ball



Tiger Stripes



Marble Gold



Black and Gold

*We provide a wide variety of interior sign styles all custom made to any specification.*

## APPLIQUÉ SIGNAGE



In this process, laser-cut tactile letters and graphics, known as “appliqué” are applied to the sign substrate with the corresponding insert braille beads.

Allows you to adhere to the Americans with Disabilities Act.

### Features

- Traditional ADA Sign Solution.
- Can be used on a variety of approved substrates.
- Thickness Options:

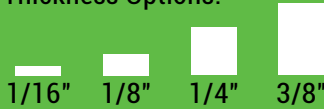

## DIRECT PRINTED SIGNAGE



In this process, vibrant, full color graphics are printed directly on a variety of substrates including plastic, acrylic and aluminum.

### Features

- Crisp, superior printing.
- UV Ink resistant to scratches and fading.
- Weatherproof.
- PMS color matching available.
- Thickness Options:

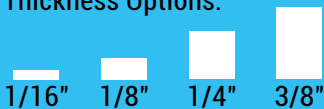

## Let's Get Creative.

ADA signage is often thought of as being plain and generic with a typical one color background and raised text or numbers in a contrasting light or dark color.

However, new design techniques, equipment and material options have changed the world of interior architectural and ADA signage! Digital graphics, logos or patterns can now be printed directly to the sign surface resulting in endless design options for your signage project. Contact us to get started!



# AVAILABLE IN AN ASSORTMENT OF SHAPES, SIZES, FINISHES AND COLORS.

Begin by selecting one of our fabrication techniques as described below

## ADA APPLIQUÉ

## ADA 3D PRINT

## ENGRAVED

## DIRECT PRINT

### ENGRAVED SIGNAGE



In this process, signs are produced using a laser engraver to engrave letters & logos into two-ply plastic, brass or aluminum substrates.

Your engraved lettering and custom design will make sure your message stands out.

#### Features

- Plastic signs are available in wall, tent or pedestal style.
- Brass and Aluminum are available in wall style only.
- Scratch resistant.
- Available with beveled or rounded edges.

#### Plastic Engraved

Sizes: Up to 24" x 48"  
Thickness Options:

- 1/16"
- 1/8"

Wall

PAYMENT IS REQUIRED WHEN SERVICES ARE RENDERED UNLESS OTHER ARRANGEMENTS ARE MADE IN ADVANCE

Pedestal



Tent

#### Brass Engraved

Thickness Options:

- .020"
- .040"

Imprint Options:

Engraved Only

Oxidized Black

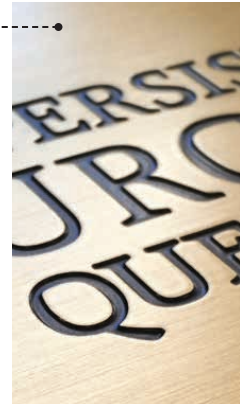

#### Aluminum Engraved

Thickness Options:

- .040"
- 1/16"

Imprint Options:

Engraved Only

Paint Filled



*We create an assortment of custom signage for your interior spaces. Explore the different types below.*

## DIRECTIONAL

**Directional signage provides accurate and easy to understand directions to guide people to their destination as simply as possible.**

Using directional signs help make your building easy to navigate with simple to read signage that inform, reinforce your brand and help improve traffic flow.



## IDENTIFICATION

**Identification signage is a style of signage that clearly marks a particular area and indicates that you have arrived at a location.**

Typically these signs specify the name or number of a room or the entrance to a department or office. They are generally placed adjacent to doorway entrances and most often ADA compliant.



## REGULATORY

**Regulatory signage is the foundation for creating a safe environment.**

Primarily ADA compliant, regulatory signage is focused on safety and liability concerns. They display a clear, concise and prominent message and is used to establish and reinforce rules, safety standards and privacy expectations.

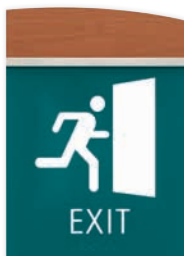

FROM WAYFINDING TO ROOM IDENTIFICATION, INTERIOR SIGNAGE IS KEY TO DELIVERING ESSENTIAL INFORMATION TO YOUR VISITORS. WE CAN HELP YOU WITH CREATING A SINGLE PIECE TO AN ENTIRE SIGNAGE ROLLOUT.

## INFORMATIONAL

Informational signage pertains to the overall facilities and provide visitors with broad information such as hours of operation, amenities, and business policies that they need while navigating.

The use of informational signage should answer questions before they're asked and be universally understandable at a glance.



## DIRECTORY

Directory signage is absolutely essential for every kind of building and enables your visitors to easily locate and navigate to the correct location within your facility.

Do you need to make changes frequently to your directory signs? We offer directory styles that can quickly be switched out as needed.



## WINDOW & INSERT

Window and Insert signage is a highly versatile signage option for practically any facility.

These signs are ideal for displaying both permanent information (room numbers or room names) and adjustable information that may need to be updated occasionally (staff names, schedules, or other items).

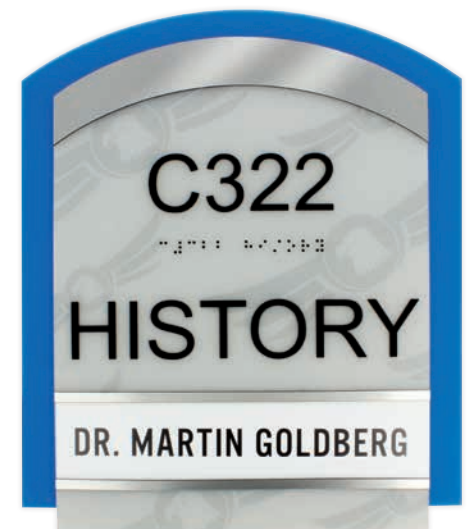
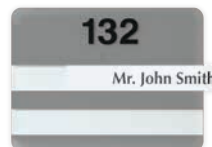
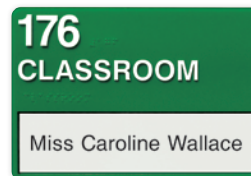
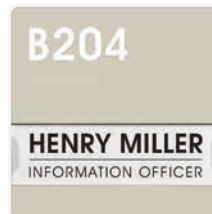

# Explore Schwaab's Signage Collection!

Designed to take the hassle out of creating a sign, our signage collection makes it very easy to create a cohesive and distinctive signage system that enhances any décor and suits any budget.

## Denali SERIES

shown in

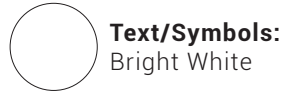
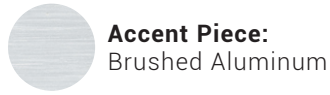

### Alternative Color Combinations To Try:



**Backer:** Air Force Blue  
**Accent:** Brushed Aluminum  
**Text/Symbols:** Bright White

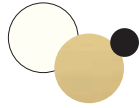

**Backer:** White  
**Accent:** European Gold  
**Text/Symbols:** Black



**Backer:** Black  
**Accent:** Brushed Aluminum  
**Text/Symbols:** Bright White



**Backer:** China Blue  
**Accent:** European Gold  
**Text/Symbols:** White



**Backer:** Burgundy  
**Accent:** Brushed Aluminum  
**Text/Symbols:** Bright White



## Avala SERIES

shown in

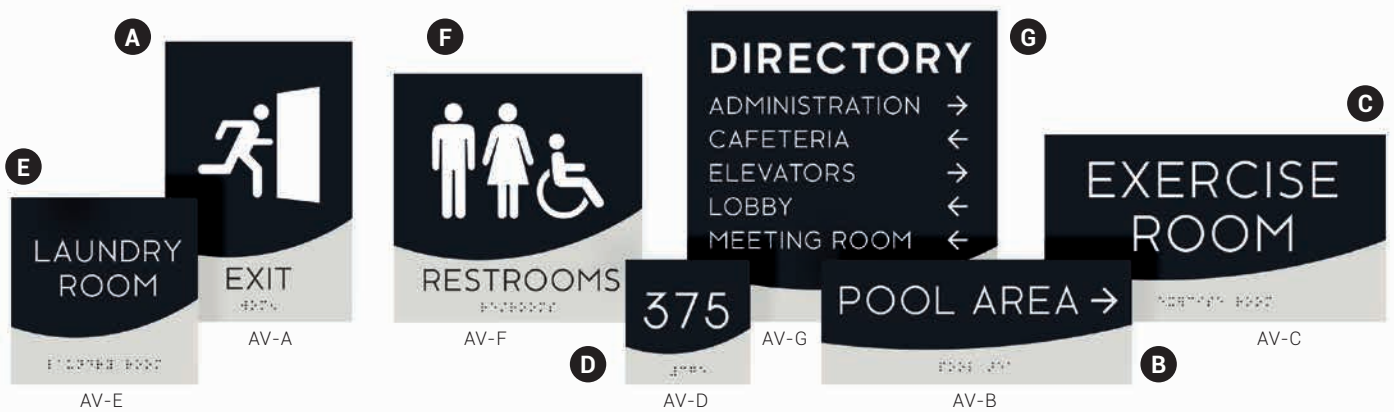
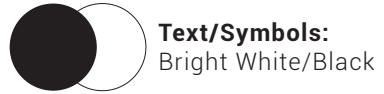
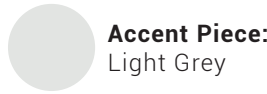
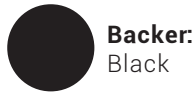

### Alternative Color Combinations To Try:



**Backer:** Grey Flannel  
**Accent:** Black  
**Text/Symbols:** Bright White



**Backer:** Marine Blue  
**Accent:** Pearl Grey  
**Text/Symbols:** Brt White/Black



**Backer:** Candlewick  
**Accent:** Black  
**Text/Symbols:** Brt White/Black



**Backer:** Coastal Blue  
**Accent:** Sandalwood  
**Text/Symbols:** White/Black



**Backer:** Slate  
**Accent:** Light Grey  
**Text/Symbols:** Brt White/Black

CHOOSE FROM A SIZE BELOW OR WE CAN CREATE A CUSTOM SIZE FOR YOU!

- A** 6" x 9"   **B** 10" x 4"   **C** 11" x 6"   **D** 4" x 4"   **E** 6" x 6"   **F** 8" x 8"   **G** 10" x 10"

## Shasta SERIES

*shown in*



**Backer:**  
Glacier



**Face:**  
Bright White



**Text/Symbols:**  
Black

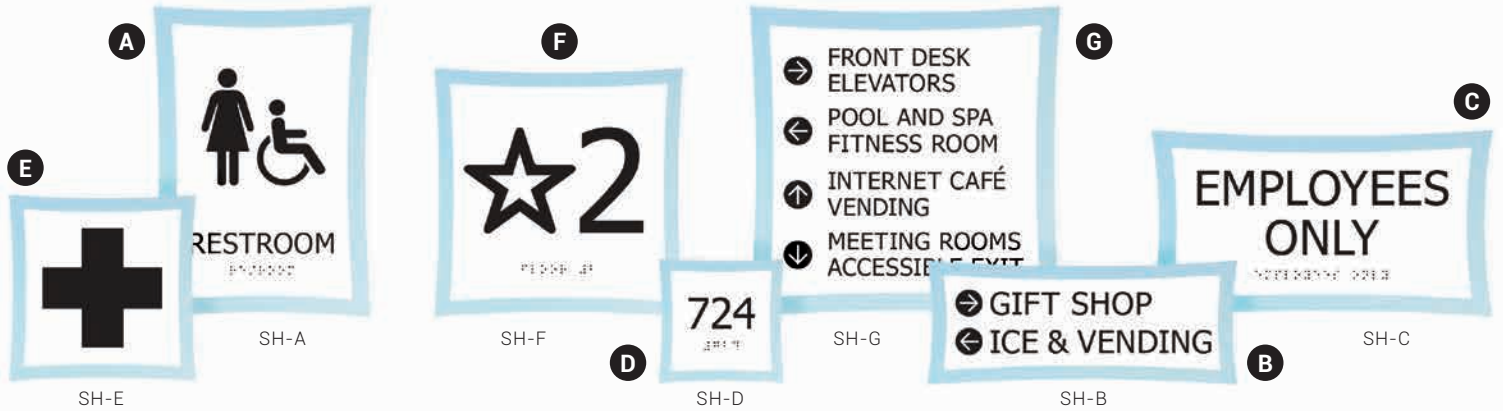

### Alternative Color Combinations To Try:

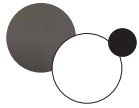

**Backer:** Smoke  
**Face:** Bright White  
**Text/Symbols:** Black

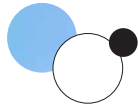

**Backer:** Wedgewood  
**Face:** Bright White  
**Text/Symbols:** Black



**Backer:** Caribbean  
**Face:** Bright White  
**Text/Symbols:** Black



**Backer:** Kiwi  
**Face:** Bright White  
**Text/Symbols:** Black

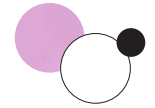

**Backer:** Wisteria  
**Face:** Bright White  
**Text/Symbols:** Black

## Cascade SERIES

*shown in*



**Backer:**  
Deep Bronze



**Face:**  
China Blue



**Text/Symbols:**  
Bright White

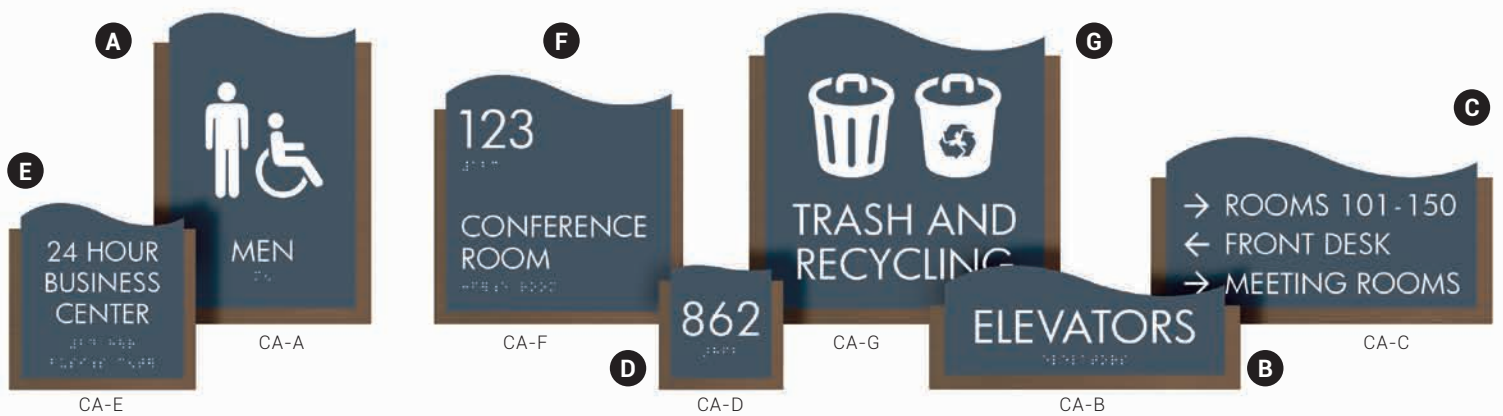

### Alternative Color Combinations To Try:



**Backer:** Sand  
**Face:** Slate  
**Text/Symbols:** Bright White



**Backer:** Cinder  
**Face:** Putty  
**Text/Symbols:** Bright White



**Backer:** Light Grey  
**Face:** Pine Green  
**Text/Symbols:** Bright White

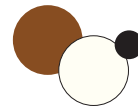

**Backer:** Copper  
**Face:** White  
**Text/Symbols:** Black



**Backer:** Graphite  
**Face:** Burgundy  
**Text/Symbols:** Bright White

VISIT THESE HELPFUL PAGES FOR YOUR DESIGN OPTIONS

- 45 COPY STYLES
- 46 SYMBOLS
- 47 COLOR CHARTS

Upgrade with Standoffs



Alpine SERIES

shown in

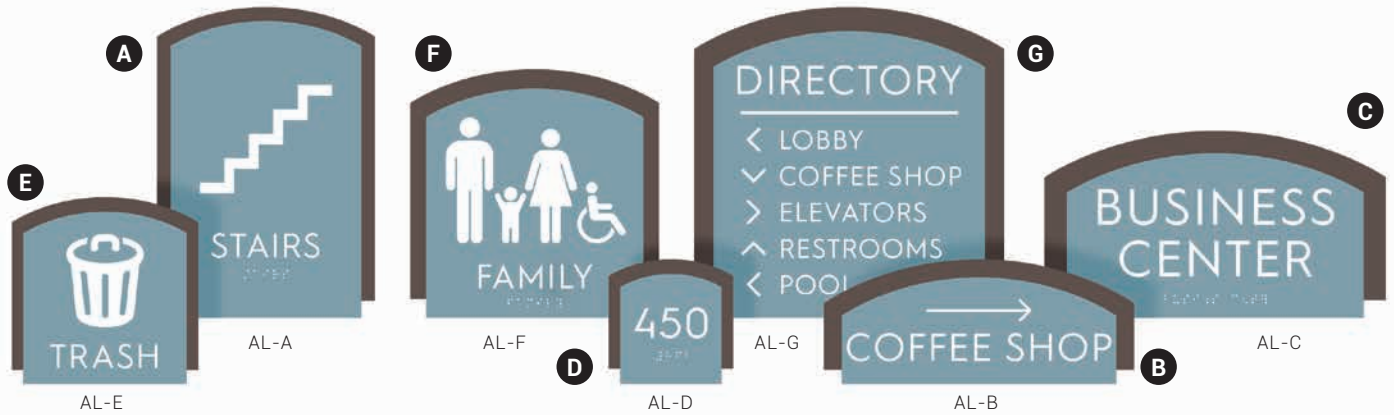
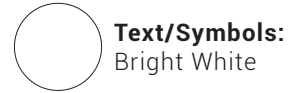
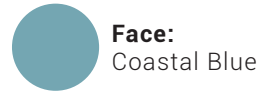

Alternative Color Combinations To Try:



Backer: Silver  
Face: Black  
Text/Symbols: Bright White



Backer: Graphite  
Face: Ash  
Text/Symbols: Black



Backer: Copper  
Face: Marine Blue  
Text/Symbols: Bright White



Backer: Canyon  
Face: Taupe  
Text/Symbols: Bright White



Backer: Light Grey  
Face: Charcoal Grey  
Text/Symbols: Bright White

Olympus SERIES

shown in

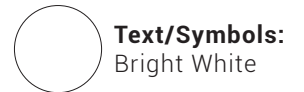
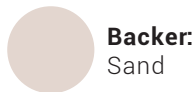

Alternative Color Combinations To Try:



Backer: Copper  
Face: Dark Brown  
Text/Symbols: Bright White



Backer: Charcoal Grey  
Face: Black  
Text/Symbols: Bright White



Backer: Light Grey  
Face: Coastal Blue  
Text/Symbols: Bright White



Backer: Taupe  
Face: Canyon  
Text/Symbols: Bright White



Backer: Gold  
Face: China Blue  
Text/Symbols: Bright White



CHOOSE FROM A SIZE BELOW OR WE CAN CREATE A CUSTOM SIZE FOR YOU!

- A** 6" x 9"   **B** 10" x 4"   **C** 11" x 6"   **D** 4" x 4"   **E** 6" x 6"   **F** 8" x 8"   **G** 10" x 10"

## Ives SERIES

*shown in*

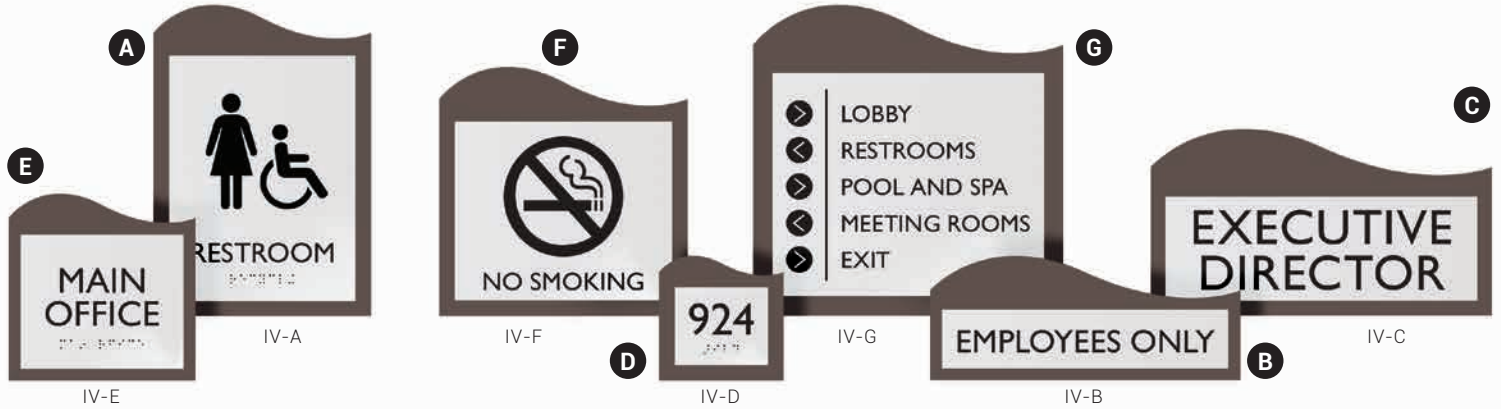
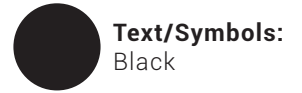

Alternative Color Combinations To Try:

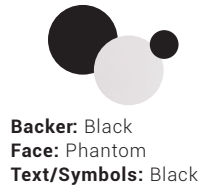
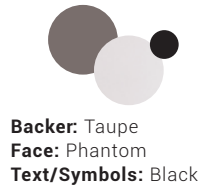
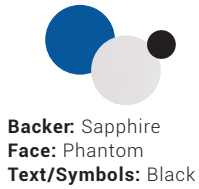

## Cheviat SERIES

*shown in*

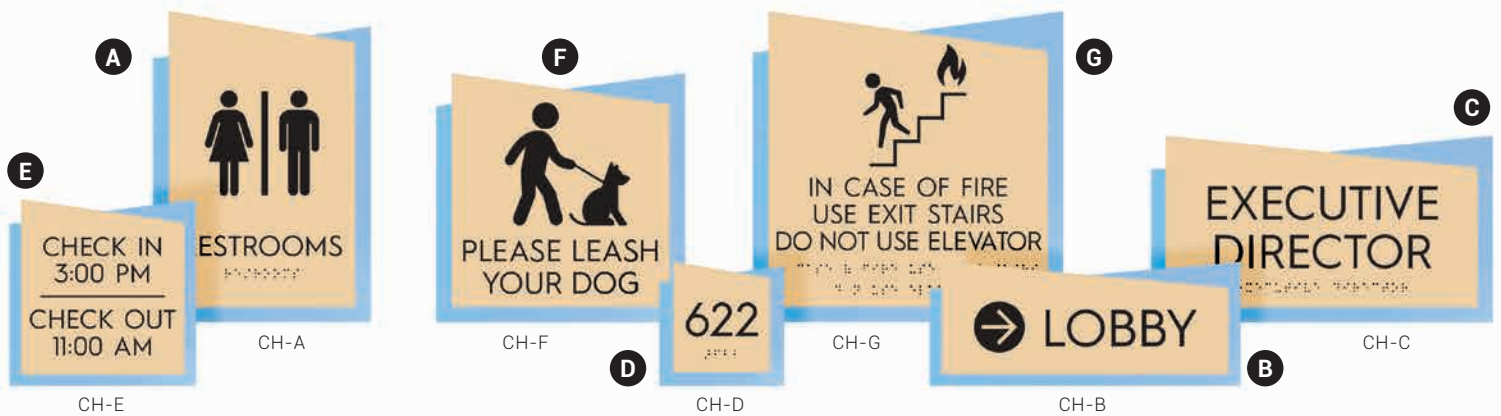
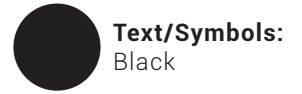
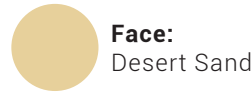

Alternative Color Combinations To Try:

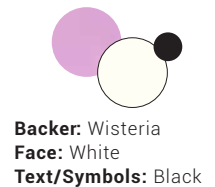
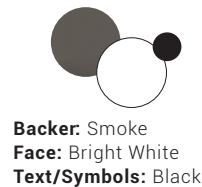
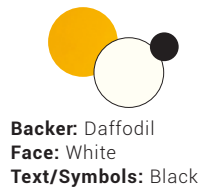

Completely Custom and on Trend:  
Luxe Signage Series

DIGITALLY PRINTED WITH VIBRANT COLORS AND DESIGNS, OUR LUXE SERIES SIGNS ARE PRODUCED USING DURABLE MATTE ACRYLIC & INCLUDE ANODIZED ALUMINUM STANDOFFS FOR A TRULY ELEGANT AND MODERN APPEARANCE.

Standard **SIZES** ▶▶

**OVAL**  
4" x 10" x 1/8"



**RECTANGULAR**  
2" x 9" x 1/8"



**SQUARE**  
6" x 6" x 1/8"

FULLY CUSTOMIZE YOUR SIGN WITH ANY PERSONALIZED TEXT, LOGO OR DESIGN YOU REQUIRE.



5/8" Diameter with 3/4" Barrel



*Standoff* **SPECS**

CUSTOM SIGNAGE SIZES AVAILABLE UPON REQUEST.

# ExcelMark All-in-One Sign Kit

OUR PLASTIC HOLDER WITH TWIST-OFFS® BRACKETS ALLOWS YOU TO PRODUCE PROFESSIONAL LOOKING SIGNS WITH EASE!

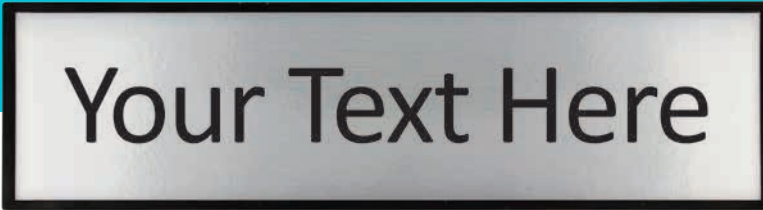

Item Number  
• DIY-NP-KIT

Finished Size  
• 2" x 8"

## CUSTOMIZABLE!

- Personalize from the comfort of your home or office.
- Free, easy-to-use, downloadable templates available online.
- Compatible laserjet printers only. (Does not work with inkjets).
- Frame also holds a 1/16" plastic nameplate.



## RE-USABLE AND ECO FRIENDLY!

- Additional Twist-Offs® and clear printable film sheets available for purchase.
- Replace only the clear film from the old nameplate.
- No need to throw away the entire sign.



## VERSATILE DISPLAY!

- Multiple mounting locations with no additional hardware required.
- Plastic leg holders easily snap into place for desk display.
- Easily secured to door or wall with installed mounts.
- Twist-Offs® wall mounts with adhesive backing for easy removal.



## Package Contents:

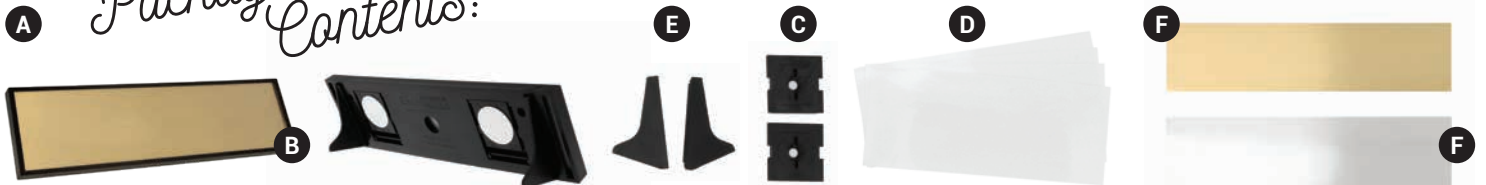

A. Sturdy 2" x 8" plastic holder (1)  
B. Clear acrylic cover (1)

C. Twist-Offs® wall mounts (2)  
D. Clear printable film sheets (4)

E. Desk holder legs (1 left, 1 right)  
F. Brushed foil inserts (1 silver, 1 gold)

### ▶ Easily mounts to walls!



#### Step 1

Peel film off adhesive discs of Twist-Offs® wall mounts on back of name plate holder.



#### Step 2

Press firmly at the desired position on the wall.  
Consider using a level for precise placement.

### ▶ Quickly removes to swap out signs!

#### Step 1

To remove from wall, apply pressure upwards to pop name plate holder off Twist-Offs® wall mounts until they release from wall.



#### Step 2

Use a coin or screwdriver to rotate Twist-Offs® wall mounts until they release from wall.  
Twisting action will release from wall without any damage.

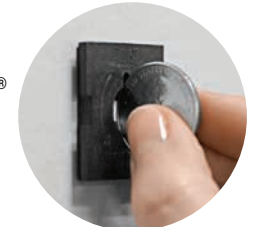

# Do you prefer to create your own custom sign?

**LET'S START DESIGNING! SIMPLY CREATE YOUR BASIC SIGN BY SELECTING YOUR SHAPE, BACKGROUND COLOR, FONT AND LETTER COLOR. IT'S THAT EASY!**

**EXAMPLE**

Shape: Arch  
 Color: Taupe  
 Font: Futura  
 Copy Color: White



## Shape **OPTIONS** ▼

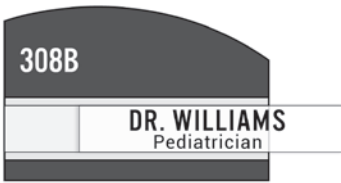
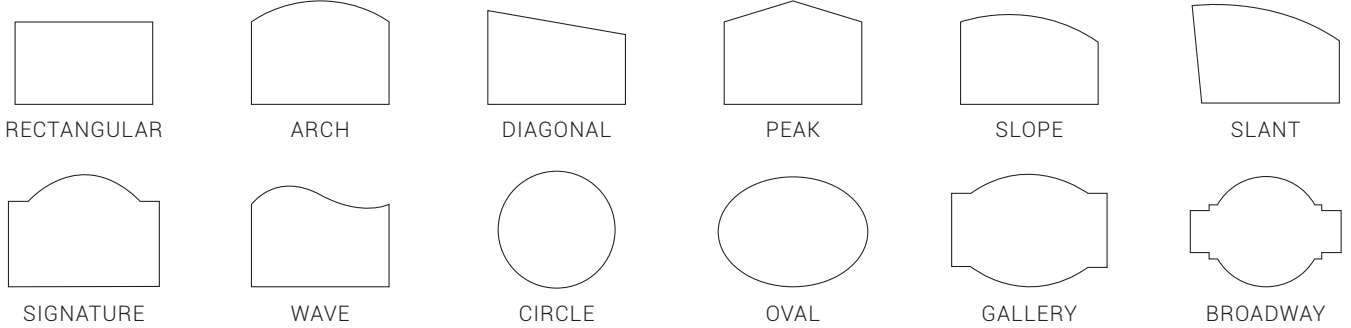

## Special **FEATURES**

Window signs with replaceable paper inserts allows you to change names with ease.

We offer custom plastic, reverse engraved, brass engraved, ADA, layered, accented, stand-off, framed, window, and changeable message options for signs.

Want something unique? We customize! Speak with one of our consultants to help create the sign you're imagining today.

## Choose **YOUR OPTIONAL ENHANCEMENTS!** ▼



# Need some Ideas? Start with one of our Layout Templates.

BEGIN BY SELECTING FROM ONE OF THESE TEMPLATES, THEN EASILY CUSTOMIZE BY ADDING YOUR INFORMATION TO MAKE IT ALL YOUR OWN!

VISIT THESE HELPFUL PAGES FOR DESIGN OPTIONS:

41 COPY STYLES

42 SYMBOLS

43 COLOR CHARTS

45 PATTERNS

RECTANGULAR ARCH DIAGONAL PEAK SLOPE SLANT SIGNATURE WAVE CIRCLE OVAL GALLERY BROADWAY

## SINGLE BACKER

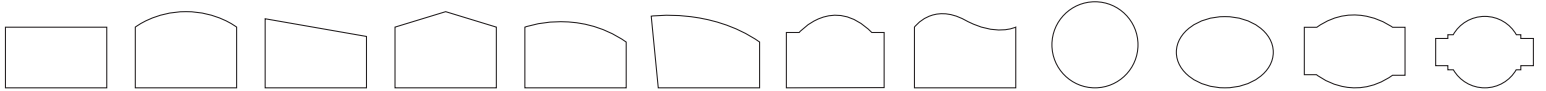

## SINGLE BACKER WITH PRINTED BACKGROUND

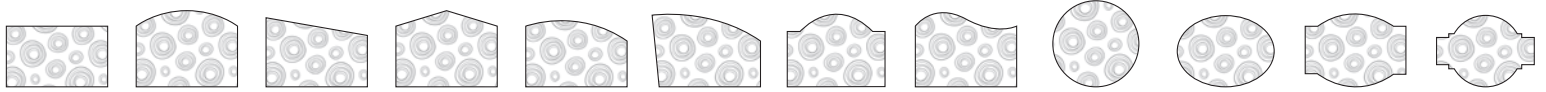

## SINGLE BACKER WITH ACCENT PIECE

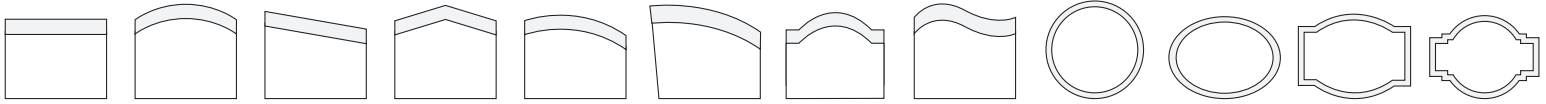

## SINGLE BACKER WITH STANDOFFS

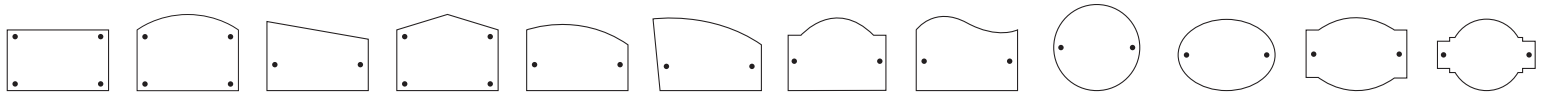

## DOUBLE BACKER

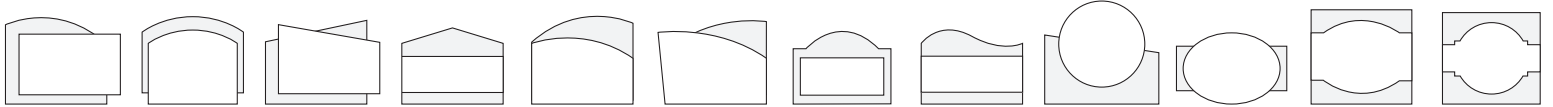

## DOUBLE BACKER WITH PRINTED BACKGROUND

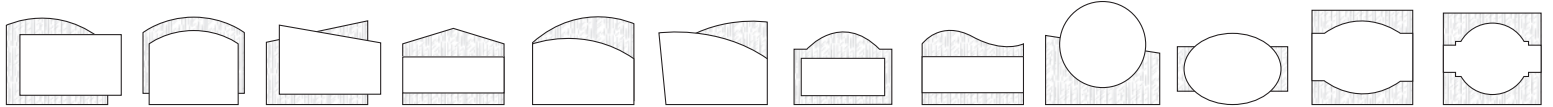

## DOUBLE BACKER WITH ACCENT PIECE

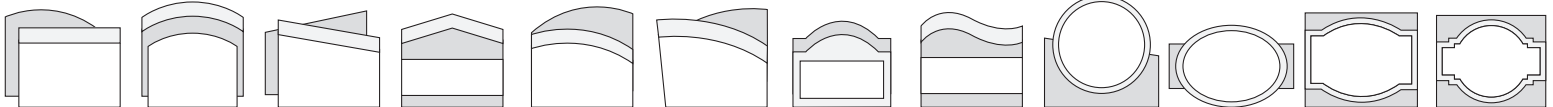

## DOUBLE BACKER WITH STANDOFFS

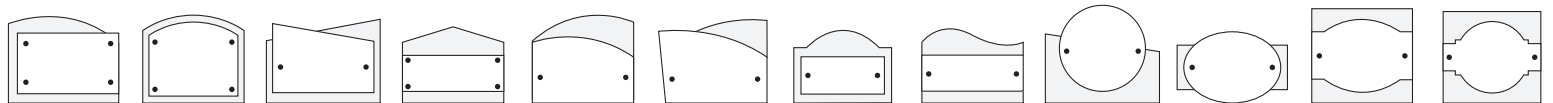

# Copy Styles ▶ ADA Compliant Type

This list displays a sample of ADA-compliant fonts for both tactile and visual characters that comply with the 2010 Standards for enhanced readability of tactile signage elements. Looking for another ADA-compliant copy style? Call us to discuss other available options.

**Arial**  
ABCDEFGHIJKLMNOPQRSTUVWXYZ  
abcdefghijklmnopqrstuvwxyz  
1234567890

**Avant Garde**  
ABCDEFGHIJKLMNOPQRSTUVWXYZ  
abcdefghijklmnopqrstuvwxyz  
1234567890

**Calibri**  
ABCDEFGHIJKLMNOPQRSTUVWXYZ  
abcdefghijklmnopqrstuvwxyz  
1234567890

**Folio**  
ABCDEFGHIJKLMNOPQRSTUVWXYZ  
abcdefghijklmnopqrstuvwxyz  
1234567890

**Franklin Gothic Book**  
ABCDEFGHIJKLMNOPQRSTUVWXYZ  
abcdefghijklmnopqrstuvwxyz  
1234567890

**Frutiger**  
ABCDEFGHIJKLMNOPQRSTUVWXYZ  
abcdefghijklmnopqrstuvwxyz  
1234567890

**Futura**  
ABCDEFGHIJKLMNOPQRSTUVWXYZ  
abcdefghijklmnopqrstuvwxyz  
1234567890

**Gill Sans**  
ABCDEFGHIJKLMNOPQRSTUVWXYZ  
abcdefghijklmnopqrstuvwxyz  
1234567890

**Gotham**  
ABCDEFGHIJKLMNOPQRSTUVWXYZ  
abcdefghijklmnopqrstuvwxyz  
1234567890

**Helvetica**  
ABCDEFGHIJKLMNOPQRSTUVWXYZ  
abcdefghijklmnopqrstuvwxyz  
1234567890

**Hurme**  
ABCDEFGHIJKLMNOPQRSTUVWXYZ  
abcdefghijklmnopqrstuvwxyz  
1234567890

**Interstate**  
ABCDEFGHIJKLMNOPQRSTUVWXYZ  
abcdefghijklmnopqrstuvwxyz  
1234567890

**Meta Book**  
ABCDEFGHIJKLMNOPQRSTUVWXYZ  
abcdefghijklmnopqrstuvwxyz  
1234567890

**Metropolis**  
ABCDEFGHIJKLMNOPQRSTUVWXYZ  
abcdefghijklmnopqrstuvwxyz  
1234567890

**Myriad**  
ABCDEFGHIJKLMNOPQRSTUVWXYZ  
abcdefghijklmnopqrstuvwxyz  
1234567890

**Rotis**  
ABCDEFGHIJKLMNOPQRSTUVWXYZ  
abcdefghijklmnopqrstuvwxyz  
1234567890

**Tahoma**  
ABCDEFGHIJKLMNOPQRSTUVWXYZ  
abcdefghijklmnopqrstuvwxyz  
1234567890

**Trade Gothic**  
ABCDEFGHIJKLMNOPQRSTUVWXYZ  
abcdefghijklmnopqrstuvwxyz  
1234567890

**U.S. 101**  
ABCDEFGHIJKLMNOPQRSTUVWXYZ  
ABCDEFGHIJKLMNOPQRSTUVWXYZ  
1234567890

**Verdana**  
ABCDEFGHIJKLMNOPQRSTUVWXYZ  
abcdefghijklmnopqrstuvwxyz  
1234567890

# Symbol Options ▶ Common Pictograms

Find the perfect pictogram for your signage project!  
 This guide displays a variety of common symbols used on ADA signage.  
 If your project requires a symbol not shown, please contact your signage consultant.



UNISEX



UNISEX  
ACCESSIBLE



WOMEN



WOMEN'S  
ACCESSIBLE



MEN



MEN'S  
ACCESSIBLE



ALL GENDER  
RESTROOM



FAMILY  
ACCESSIBLE



GENDER  
NEUTRAL



HANDICAP



GIRLS  
STYLE 1



GIRLS  
ACCESSIBLE  
STYLE 1



BOYS  
STYLE 1



BOYS  
ACCESSIBLE  
STYLE 1



GIRLS  
STYLE 2



GIRLS  
ACCESSIBLE  
STYLE 2



BOYS  
STYLE 2



BOYS  
ACCESSIBLE  
STYLE 2



TOILET



STAIRS



STAIRS/  
FIRE



ELEVATOR



EXIT



NY / CT  
ACCESSIBLE



FIRST  
AID



LACTATION  
ROOM



BABY



MEDICAL



EYE WASH  
STATION



SHOWER



AED  
AED



DO NOT  
ENTER



NO  
SMOKING



NO  
E-CIGARETTES



SMOKING  
AREA



NO  
WEAPONS



NO FOOD  
OR DRINK



NO MOBILE  
PHONES



INFORMATION



STOP



TDD  
TELEPHONE



TELEPHONE  
VOLUME  
CONTROL



TELEPHONE



DEAF



GENDER  
INCLUSIVE



ELECTRICAL



FIRE  
EXTINGUISHER



HOSE  
EXTINGUISHER



VIDEO  
SURVEILLANCE



STORM  
SHELTER



SHELTER  
IN PLACE



RECYCLE



DRINKING  
FOUNTAIN



JANITORIAL



PET



COAT  
ROOM



LOST &  
FOUND



VENDING



ARROW  
STYLE 1



ARROW  
STYLE 2



ARROW  
STYLE 3



ARROW  
STYLE 4



ARROW  
STYLE 5

# Color Charts ▶ Find just the Right Color!

## ADA Alternative® | Substrate & Appliqué

This matte finished product complies with the federal regulations for tactile signage in the Americans with Disabilities Act (ADA), and comes in a variety of colors to match any project.

**THICKNESS OPTIONS:** 1/32", 1/16", 1/8", 1/4" (\*select colors)

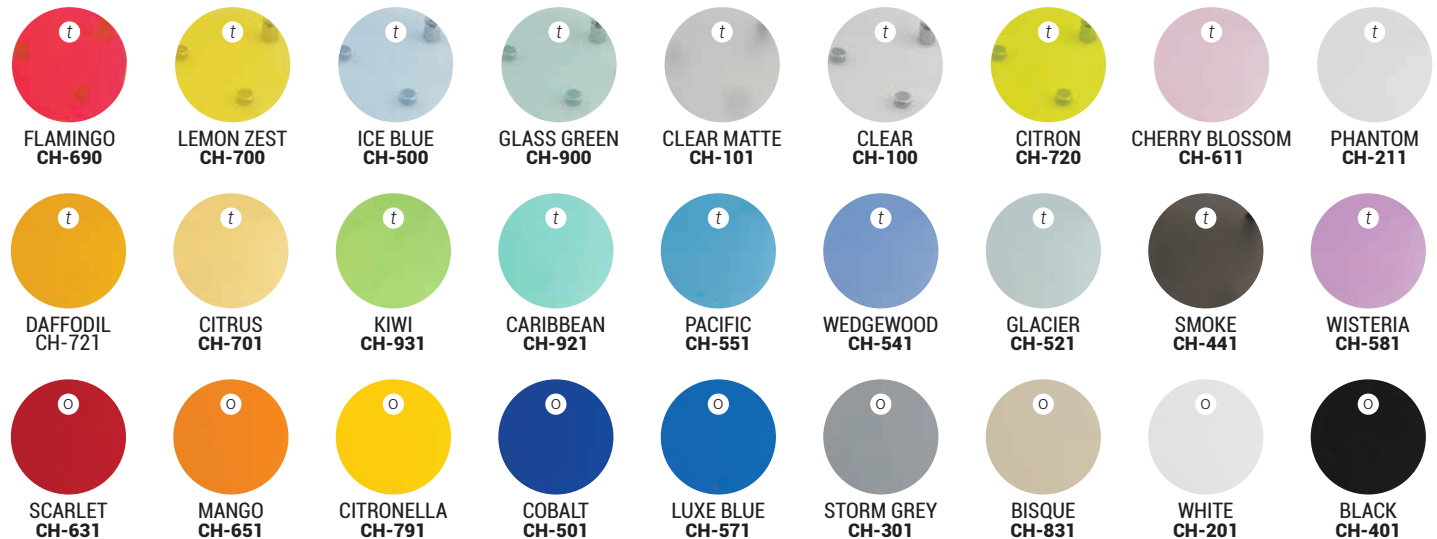
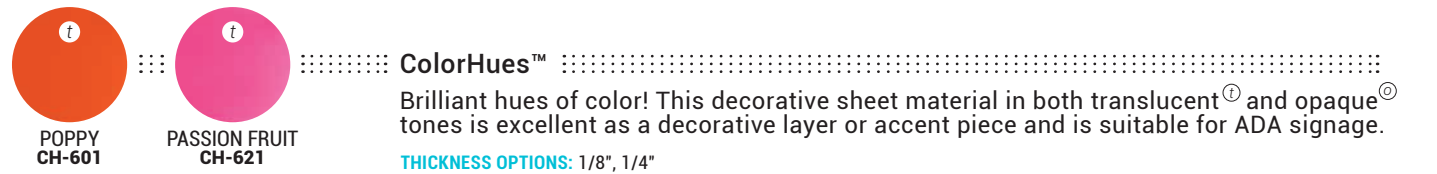
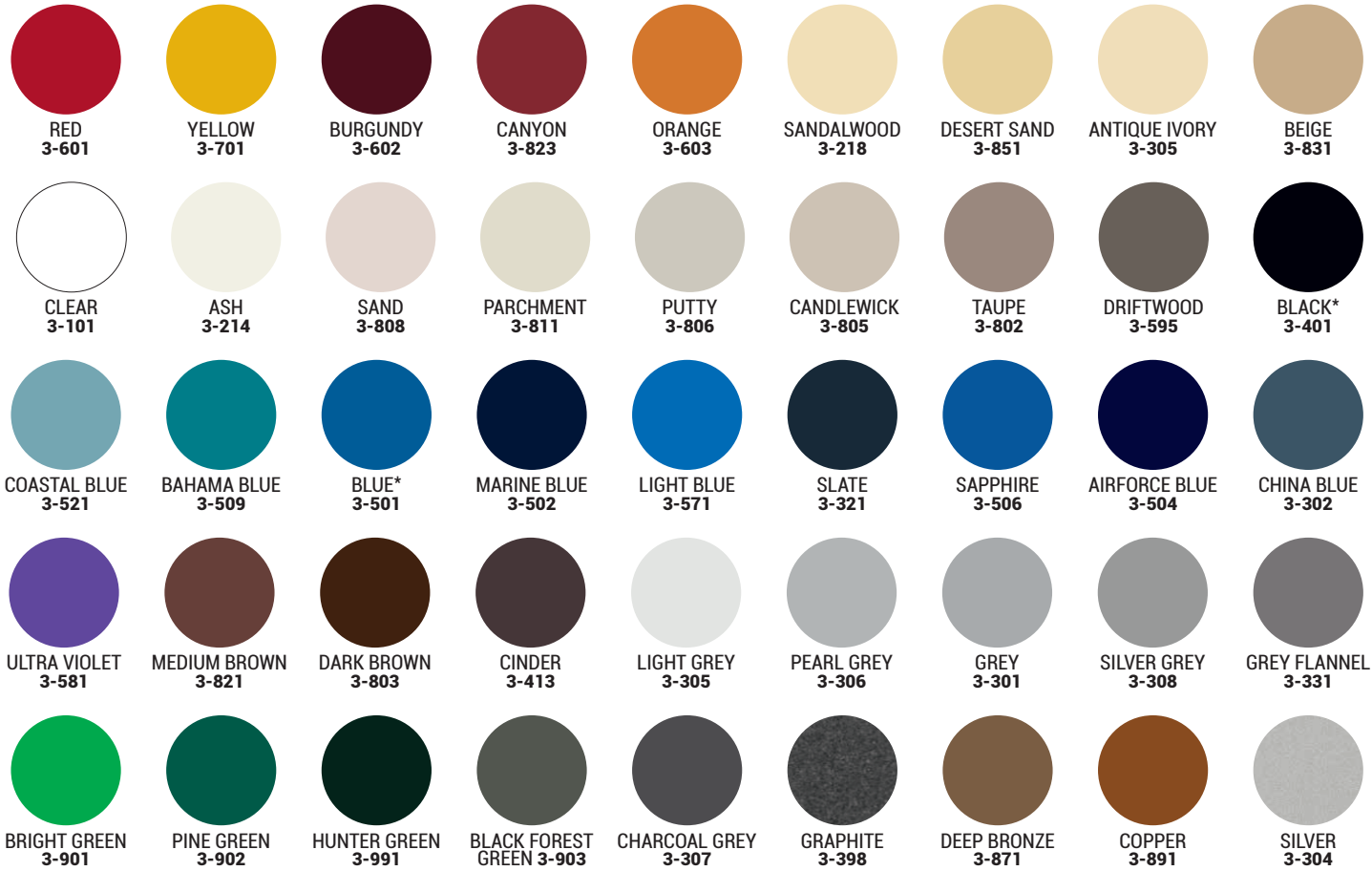
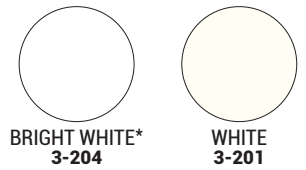



We do our best to ensure that our photos are as true to color as possible and representative of the actual material colors, but please note that colors may vary.

*Thickness Options*

1/32" 1/16" 1/8" 1/4"

**Metallics** (core color : black)

Incorporating the look of metal, this variety of plastic substrates is perfect for front engraved signs, decorative layers & accent pieces.

THICKNESS OPTIONS: 1/32", 1/16"



**The Naturals** (see swatch for core color)

Featuring the contemporary look and feel of marble, granite and wood, this collection is idea for all types of signage including front engraved, decorative layers and accent pieces. THICKNESS OPTIONS: 1/16", 1/8"

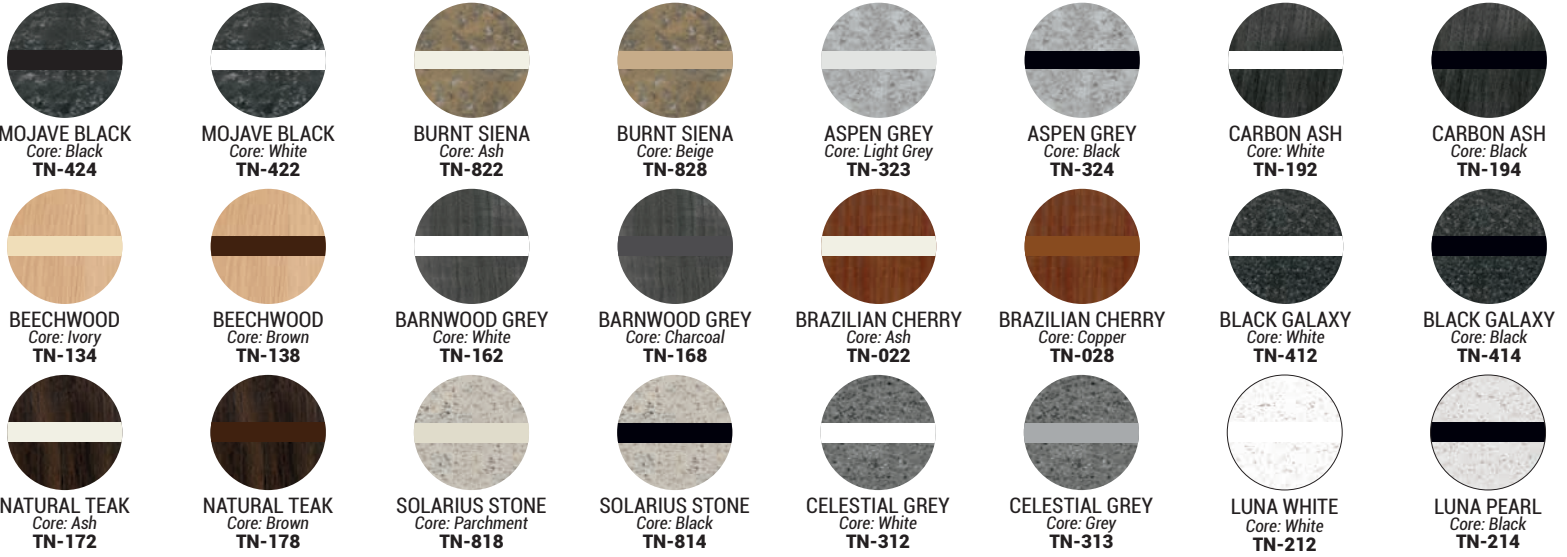

**Engraved**

This high quality & durable 2-Ply material comes in many colors and is a perfect surface for interior signs, desk plates & name badges. THICKNESS OPTIONS: 1/16", 1/8"

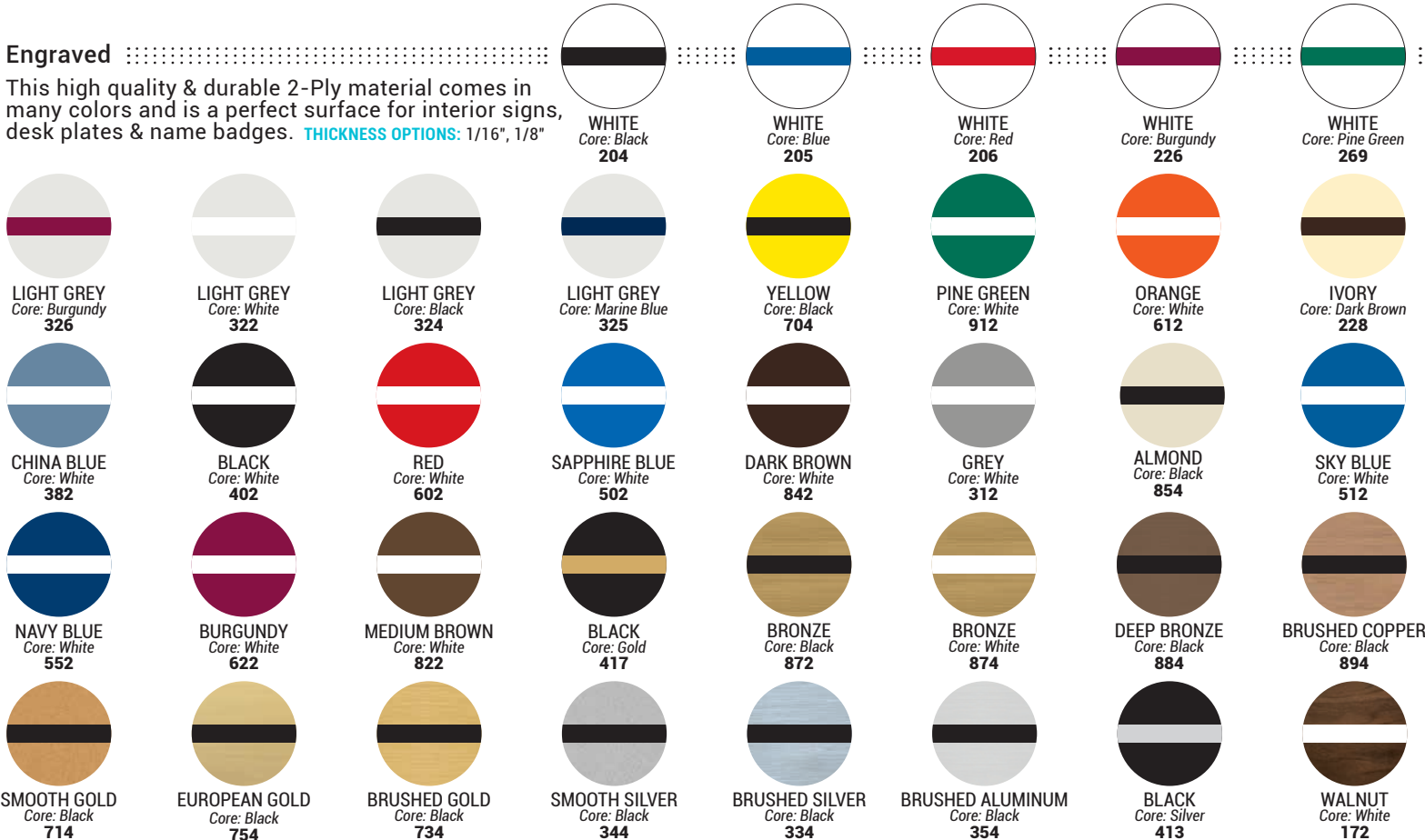

# Pattern Styles ▶ Make Your Design Pop!

Enhance the look of your signage by adding a digitally printed pattern. Choose from one of the many options below to add compliment and style to your custom design.

Have your own pattern that you would like to use? Just give us a call to chat about it!



GINKGO



DIAMOND SKETCH

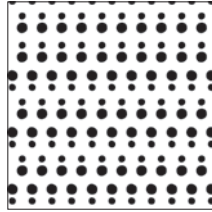

FREEFORM DOTS

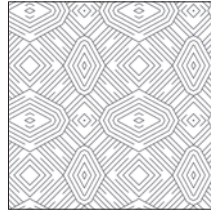

WEAVE

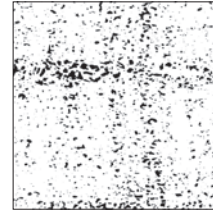

ETCH

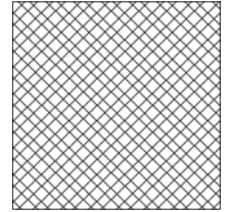

GRID

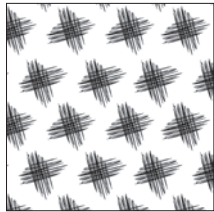

HATCH

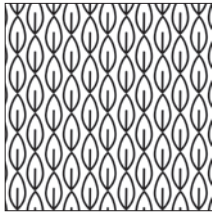

LEAF

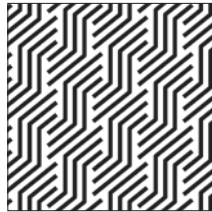

GEOMETRIC

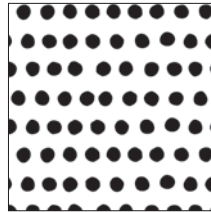

DOT

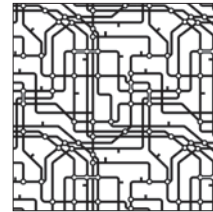

PARALLEL

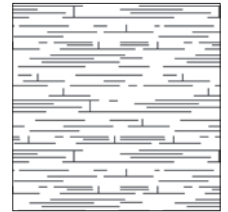

LINEAR



GREEK KEY



WAVE

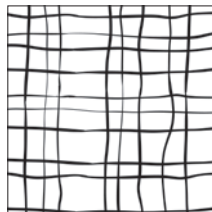

FREEFORM LINES

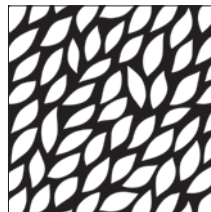

ORGANIC

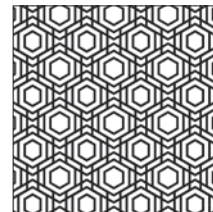

HEX

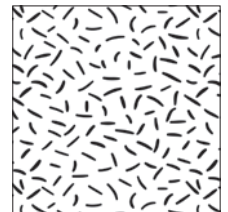

SPRINKLE



NATURAL



CHANNEL

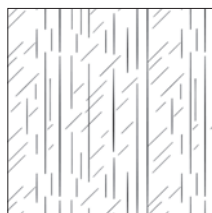

DASHED

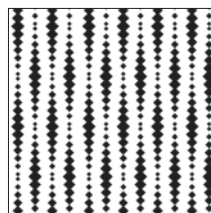

RHYTHMIC

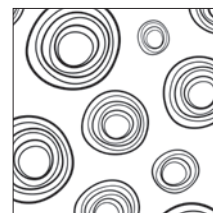

CIRCULAR

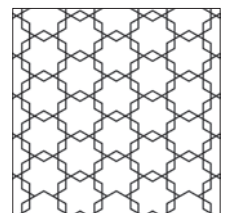

INTERSECT

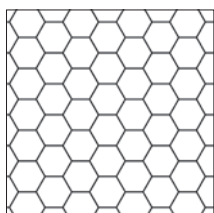

HONEY

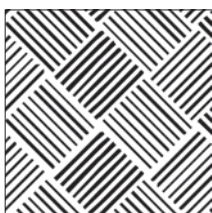

MESH

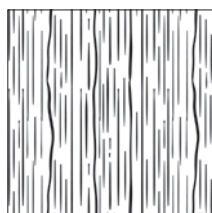

SKETCH LINE



FOLIAGE

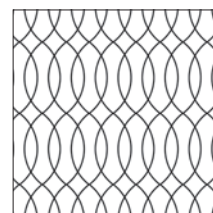

OPTIC

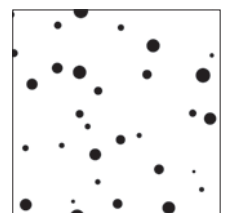

SCATTER

# Stock ADA Signs

**WE HELP MAKE YOUR FACILITY ACCESSIBLE.**

With raised pictograms and Grade II braille, our stock designs comply with ADA regulations and are a great solution for temporary signage!



Men's Restroom  
**ADA01**



Men's Accessible Restroom  
**ADA02**



Women's Restroom  
**ADA03**



Women's Accessible Restroom  
**ADA04**



Unisex Restroom  
**ADA05**



Unisex Accessible Restroom  
**ADA06**



All Gender Accessible Restroom  
**ADA07**



Exit  
**ADA08**



Baby Changing Area  
**ADA09**

*In Stock* and Read to Ship!

Size:  
6" x 9"



Thickness:  
1/16" Injection  
Molded Plastic

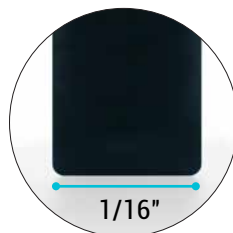

Mounting:  
All signs include  
Double Sided Tape



# Traditional HOLDERS



Constructed from sturdy aluminum, our traditional holders are available in a variety of sizes and styles to enhance any sign and enrich your décor.

### Holder Colors:

- Black
- Silver
- Gold
- Rose Gold



WALL  
HOLDERS



DESK  
HOLDERS



DESK  
BASES



CEILING & CORRIDOR  
BRACKETS

# Custom FRAMES



Custom sign frames provide a sophisticated finish to your sign while complementing any surrounding. Choose from a variety of styles to fit any need.



COHERENT  
WINDOW SERIES



VISTA CLARA  
FRAMES



CURVES  
SIGN SYSTEM



ARCHITECTURAL  
ALUMINUM

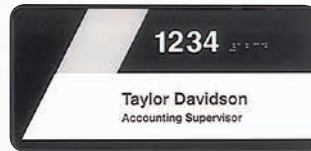

ARCHITECTURAL  
PLASTIC



XTERIOR  
OUTDOOR FRAMES



DESIGNER  
FRAMES



DECORATIVE  
BARS & RAILS



EURO  
SIGN SYSTEM



PREMIER  
FRAMES



PREMIER  
PLUS FRAMES

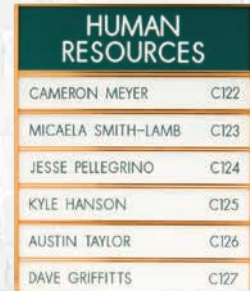

FLEX  
FRAMES

Our signage experts can assist you with selecting the frame that best suits your project and budget. Contact us for details and assistance.

# CU ALUMINUM SIGN HOLDERS

These versatile CU Sign Holders are designed to work with 1/16" engraved/printed plastic or printed paper/vinyl with our clear cover that is included.

## Features

- Each holder comes with end caps that enables you to create a wall or desk sign!



## Aluminum Sign Holders

Item #	Size
CU10050B	1" x 5"
CU10080B	1" x 8"
CU10100B	1" x 10"
CU20080B	2" x 8"
CU20100B	2" x 10"
CU20120B	2" x 12"
CU40060B	4" x 6"
CU40080B	4" x 8"
CU40120B	4" x 12"
CU60060B	6" x 6"
CU60080B	6" x 8"
CU60120B	6" x 12"

# ALUMINUM SLIDE BARS, DIVIDER BARS AND PVC SLIDE PLATES

When you incorporate our Slide Bar and PVC Slide Plate w/ Knob you enable the message to change by sliding the plate to one side or the other.

## Features

- Perfect for a message that can change frequently such as "In-Use/Vacant".
- Color: Silver



## Aluminum Slide Bars

Item #	Size
FB006	6" Length
FB008	8" Length
FB010	10" Length
FB012	12" Length



## Aluminum Divider Bars

Item #	Size
TB006	6" Length
TB008	8" Length
TB010	10" Length
TB012	12" Length

## PVC Slide Plate w/ Knob

Item #	Size
ILK1040	1" x 4.1"
ILK1050	1" x 5.1"
ILK1060	1" x 6.1"
ILK2040	2" x 4.1"
ILK2050	2" x 5.1"
ILK2060	2" x 6.1"

## Divider Bar Assembly:

Our Divider Bar is attached with adhesive that allows you to apply it to a solid piece of sign material or clear cover, thus creating a sign with-in a sign. The divider bar does not lock into the end caps but fits securely due to the adhesive tape.

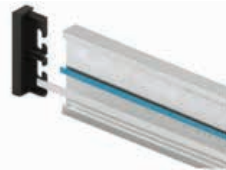

1. Insert the divider bar by adhesive on the insert at your desired position.

2. Complete the sign by closing both ends by the caps

## CU Slide Bar Assembly:

Our Slide Bar interlocks with our end caps, allowing you to make a sign within a sign. The slide bar is also used if a film/paper is printed & covered with clear plastic. The lip on the slide bar allows the material to moved left or right before securing with end caps.



1. Install one side's wall cap.

2. Slide in the insert, PVC slider.

3. Insert the slide bar into the cap groove the plate edge, make sure the slot on one side of the slide bar is close to the insert and PVC slider.

4. Fix the other side.

## CHANGEABLE MESSAGE FRAMES

Special requirements for room control and identification are accomplished with these unique frames of anodized aluminum.

### Features

- Both 1/16" wall and 1/8" wall frames have 1/2" outside depth plus 1/8" backer and 3/16" inside depth.
- Frame sizes are all inside dimensions.
- Choose from Round or Square corner options.
- All frames on this page are available in custom sizes. Please request quote.

### Holder Colors

- Black
- Silver
- Gold



- 6" x 6" frame containing a 1" x 6" extrusion for a 1/16" message plate and a secondary 1/16" slot for a 1" x 3" sliding plate to uncover alternating messages.

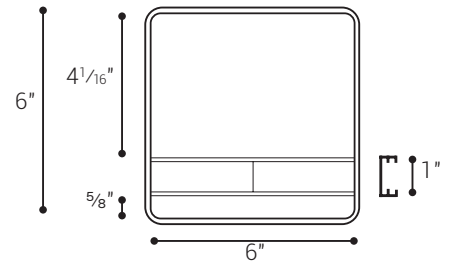

- 8" x 8" frame containing a 1" x 8" extrusion for a 1/16" message plate and a secondary 1/16" slot for a 1" x 4" sliding plate to uncover alternating messages.

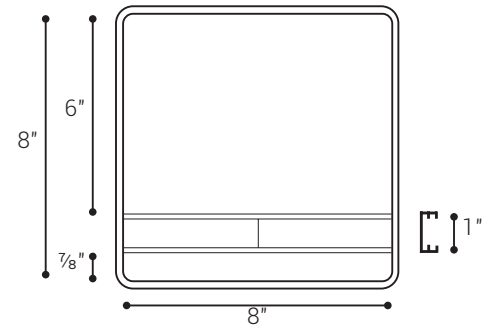

- 2" x 13" slider frame is designed for 2" x 10" message plates to slide left or right to expose message at opposite end.

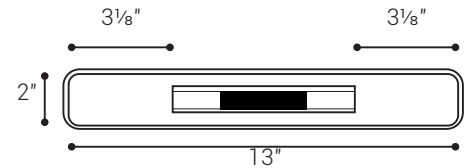

## MINI DIRECTORIES

These pre-formatted Mini-Directory frames make it easy to provide simple to read directories and are perfect for quick status updates.

### Features

- Unique changeable message frames that are perfect for quick updates.
- Frame sizes are all inside dimensions.
- Custom lengths are available.

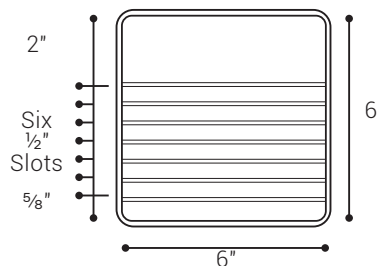

- 6" x 6" mini-directory features a one-piece magnetic backed extrusion with six 1/16" x 6" slots for easy plate changes.

### Item # Wall Thickness Size

Item #	Wall Thickness	Size
MD66	1/16", 1/8"	6" x 6"
MD88	1/16", 1/8"	8" x 8"

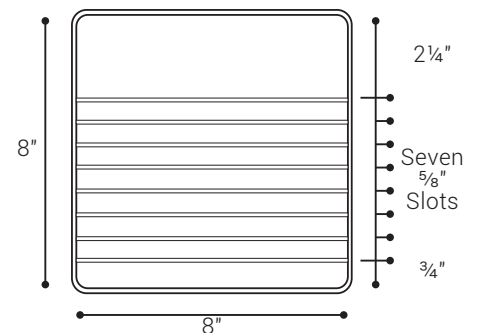

- 8" x 8" mini-directory features a one-piece magnetic backed extrusion with seven 5/8" x 8" slots for easy plate changes.

Please contact customer service for custom sizes, specialty options and additional details.

## BANNERS

- Banners are an economical, yet dynamic way to advertise in a format that is guaranteed to get noticed.

### Material

- 13 oz. reinforced vinyl with sturdy grommets.
- 4-color process printing.

### Art

- There are no art charges for orders with approved art. Add \$30 for artwork preparation.

### Sizes

- Up to 4' x 18'

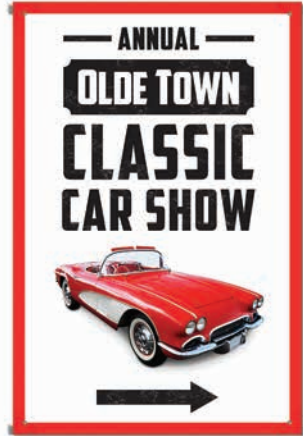

## CORRUGATED SIGNS

- Yard Signs are a durable and versatile outdoor signage solution.

### Material

- White Corrugated Plastic.
- All flutes run vertically.
- 4-color process printing .

### Art Charges

- There are no art charges for orders with approved art. Add \$25 for artwork that does not meet specifications.

### Sizes

- Up to 24" x 24"

### Copy + Color Changes

- \$40 each.

### Frames

- Frames are sold separately.



Frame  
Item: 45132

## VINYL DECALS

- Item: 45701
- Material: White Vinyl, Clear Vinyl Face Adhesive, Clear Vinyl Back Adhesive
- Imprint: White or 4-Color Process
- Corners: Square or Round



## STATIC CLING DECALS

- Item: 45702
- Material: White Static Cling, Clear Static Cling Face, Clear Static Cling Back
- Imprint: White or 4-Color Process
- Corners: Square or Round



## BUMPER STICKERS

- Item: 45706
- Rectangle Bumper Stickers include a 1/4" tab for easy removal. The oval and circle sizes will be scored on the liner.
- Static Vinyl Bumper Stickers have no adhesive and are meant for inside window application.
- Backside printing is available on Bumper Stickers with adhesive. We cannot backside print on Static Vinyl. Cost is the same as an additional ink color.



# BUSINESS HOUR WINDOW DECALS

Stand out from the competition and clearly communicate business hours for patrons with our custom Business Hour Window Decals!

Style 1  
10" x 12"

**YOUR COMPANY NAME**  
**MON-FRI 9:00 TO 5:00**  
**SAT 10:00 TO 2:00**  
**SUN CLOSED**  
 www.yourwebsitehere.com  
**123-456-7890**

Style 2  
12" x 12 1/2"

**BUSINESS HOURS**  
**MON 8:00AM - 5:00PM**  
**TUE 8:00AM - 5:00PM**  
**WED 8:00AM - 5:00PM**  
**THU 8:00AM - 5:00PM**  
**FRI 8:00AM - 5:00PM**  
**SAT 10:00AM - 2:00PM**  
**SUN — CLOSED —**

Style 3  
15 3/4" x 12"

**HOURS**  
**MON 9AM - 5PM**  
**TUE 9AM - 5PM**  
**WED 9AM - 5PM**  
**THU 9AM - 5PM**  
**FRI 9AM - 5PM**  
**SAT 9AM - NOON**  
**SUN CLOSED**

**OPEN HOURS**  
**MON - FRI 7:00AM - 4:00PM**  
**SAT & SUN 9:00AM - 2:00PM**  
**WALK-INS WELCOME**

Style 4  
12" x 18 1/4"

**STORE HOURS**  
**MONDAY - FRIDAY**  
**7:00AM - 6:00 PM**

Style 5  
12" x 24"

Style 6  
14 7/8" x 12"

**OPEN HOURS**  
**MON 9am - 5pm**  
**TUE 9am - 5pm**  
**WED 9am - 5pm**  
**THU 9am - 5pm**  
**FRI 9am - 5pm**  
**SAT 9am - 3pm**  
**SUN -CLOSED-**

*Item Number*

- 45705

*Material*

- Available in clear vinyl with a face adhesive to place inside window and be seen from the outside.

*Design Options*

- Templates below can be customized to include your choice of wording.

*Imprint Color*

- Any imprint color available.

# SERVICE REMINDER DECALS Get your customers returning back to you with our Service Reminder Decals!

*Item Number*

- SC-SVC

*Material*

- White Static cling vinyl for easy application and removal.

*Size*

- 2 1/2" x 1 1/2"

*Imprint Colors*

- Black ● Red ● Blue
- Green ● Purple

Style 1

**COMPANY NAME HERE**  
 1234 E. Main St.  
 Anytown, US 54321  
 (555) 555-9876  
**Next Service Due**  
 Date   
 Mile

Style 2

**COMPANY NAME HERE** *Your logo here.*  
 1234 E. Main St. Anytown, US 54321  
**555-555-0404**  
**NEXT SERVICE DUE**  
 DATE  MILES

Style 3

*Your Logo or Company Name Here*  
 1234 E. Main St. Anytown, US 54321  
**NEXT SERVICE DUE**  
 DATE  MILES

Style 4

**COMPANY NAME HERE**  
**Next Service Due**  
 Date: \_\_\_\_\_  
 Miles: \_\_\_\_\_  
 Type of Oil Used  High Mileage  
 Conventional  Semi-Synthetic  
 Green Oil  Premium Synthetic  
 Reset Oil Monitor Light  Y  N/A

Style 5

**COMPANY NAME HERE** *Your logo here.*  
 1234 E. Main St. Anytown, US 54321  
 www.website.com  
**SAVE \$3.00 OFF**  
**YOUR NEXT SERVICE**  
**555-555-0404**

Style 6

**SAVE YOUR TIRES!**  
**YOUR NEXT TIRE ROTATION DUE**  
**at**  **miles**  
**COMPANY NAME HERE**  
**555-555-0404**  
 1234 E. Main St. Anytown, US 54321

*The Versatile Signage Solution!*

**OUR FLOOR AND WALL DECALS ARE PERFECT FOR ADVERTISING, WAYFINDING, COMMUNICATING POLICIES AND PROMOTING SAFETY.**

**11 INCH DECAL APPLICATIONS**

See our complete line of stock designs at [www.schwaab.com](http://www.schwaab.com)



FLD-SD11-2



FLD-SD11-3



FLD-SD11-1

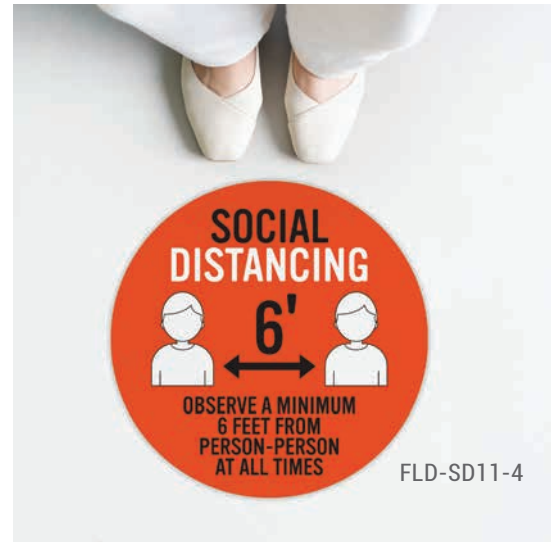

FLD-SD11-4

*Social Distancing* ▶▶



FLD-ARW7



FLD-SD-DSN19



FLD-ARW3



FLD-ARW8

◀◀ *Traffic Flow*

**VINYL STAIRWAY AND WALL DECALS**

Easily mix and match our stair & wall decals to direct traffic flow!

Wall Decals: 8" H x 16" L

Stair Decals: 3" H x 16" L



FLD-SD-DSN22



FLD-SD-DSN23



FLD-SD-DSN20



FLD-SD-DSN21



## MATERIAL:

High grade polyester floor and wall vinyl.

## DECAL FEATURES:

- Multi-Surface Use
- Durable Material
- Anti-Slip Material
- High Scuff Resistance
- Outdoor Use Approved
- Easy Removal

## APPLICATION SURFACES:

All smooth hard floors including concrete, tile, laminate, hardwood and some low pile carpet tiles.

TCHR-FLD-11DSN111



TCHR-FLD-11DSN136



TCHR-FLD-11DSN103



TCHR-FLD-11DSN41

*Classroom* ▶▶

WH-FLD-11-DSN43



WH-FLD-11-DSN34



WH-FLD-11-DSN55



WH-FLD-11-DSN8



◀◀ *Safety Graphics*

## CUSTOM FLOOR DECALS

**Do you have a design of your own or would like for us to customize one of our stock designs to complement your branding?**

You can order custom decals in any size, shape and quantity for your business or retail space. Windows, walls or floor - these durable decals can also be used for seasonal promotions or to add extra branding to your space. Contact us to learn more!



Make your first impression a lasting impression with business cards from Schwaab.

### RAISED PRINT BUSINESS CARDS

Thermography is a cost-effective raised ink business card that can add a subtle enhancement on any business card.

- Printed with up to 3 spot PMS colors.



Add some **dimension** to your design!



### DIGITAL FULL COLOR BUSINESS CARDS

Digital full color business cards can make a lasting impression with vivid, eye-popping colors.



Vibrant **FULL COLOR** printing!



## PRINT STYLES:

Select from raised print thermography or digital full color.

## PAPER CHOICES:

See below to choose from an extensive range of paper stocks.

## DESIGN OPTIONS:

- Horizontal or vertical layouts
- Full bleed is available
- Single or double-sided printing is available

## SIZE:

2" x 3½"

## BUSINESS CARD PAPER STOCK OPTIONS AVAILABLE FOR BOTH RAISED AND DIGITAL PRINT

UV Ultra II - Translucent Radiant White 36lb.

House White Vellum 80lb. / 100lb.

Cougar Cover 80lb. / 100lb. / 130 lb.

Astrobright 65lb.

Cougar Natural 80lb.

Lynx Cover 80lb. / 100lb.

Solar Yellow

Royal Linen 80lb.

Rocket Red

Brilliant White

Cosmic Orange

Natural

Lunar Blue

Ivory

Gamma Green

Gray

Astroparche 65lb.

Royal Fiber 80lb.

Exact Index 110lb.

Natural

White

Flo Gl Cover Gloss 100lb.

Aged

Natural

Kromekote 10pt C1S / C2S

Ancient Gold

Cream

Kromekote 12pt. C1S / C2S

Gray

Gray

Tango 14pt. C2S Gloss

Classic Linen 80lb. / 100lb.

Classic Laid 80lb.

Classic Crest 80lb. / 110lb.

Solar White

Solar White

Solar White

Natural White

Natural White

Natural White

Baronial Ivory

Baronial Ivory

Baronial Ivory

Antique Gray

Antique Gray

Antique Gray

## RAISED PRINT STANDARD INK COLORS

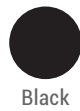

Black



Pantone Cool Gray 11



Gray PMS 423

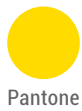

Pantone Yellow



Orange PMS 165

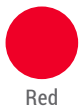

Red PMS 185



Red PMS 485



Burgundy PMS 201



Process Blue



Reflex Blue



Navy Blue PMS 2955

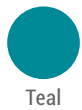

Teal PMS 321



Green PMS 348



Brown PMS 469



Gold PMS 872



Silver PMS 877

Contact us for any questions, pricing or to place your custom order.

**CUSTOM PRINTED ENVELOPES** Match your custom envelope to your letterhead and business card to create a cohesive look to all your correspondence.

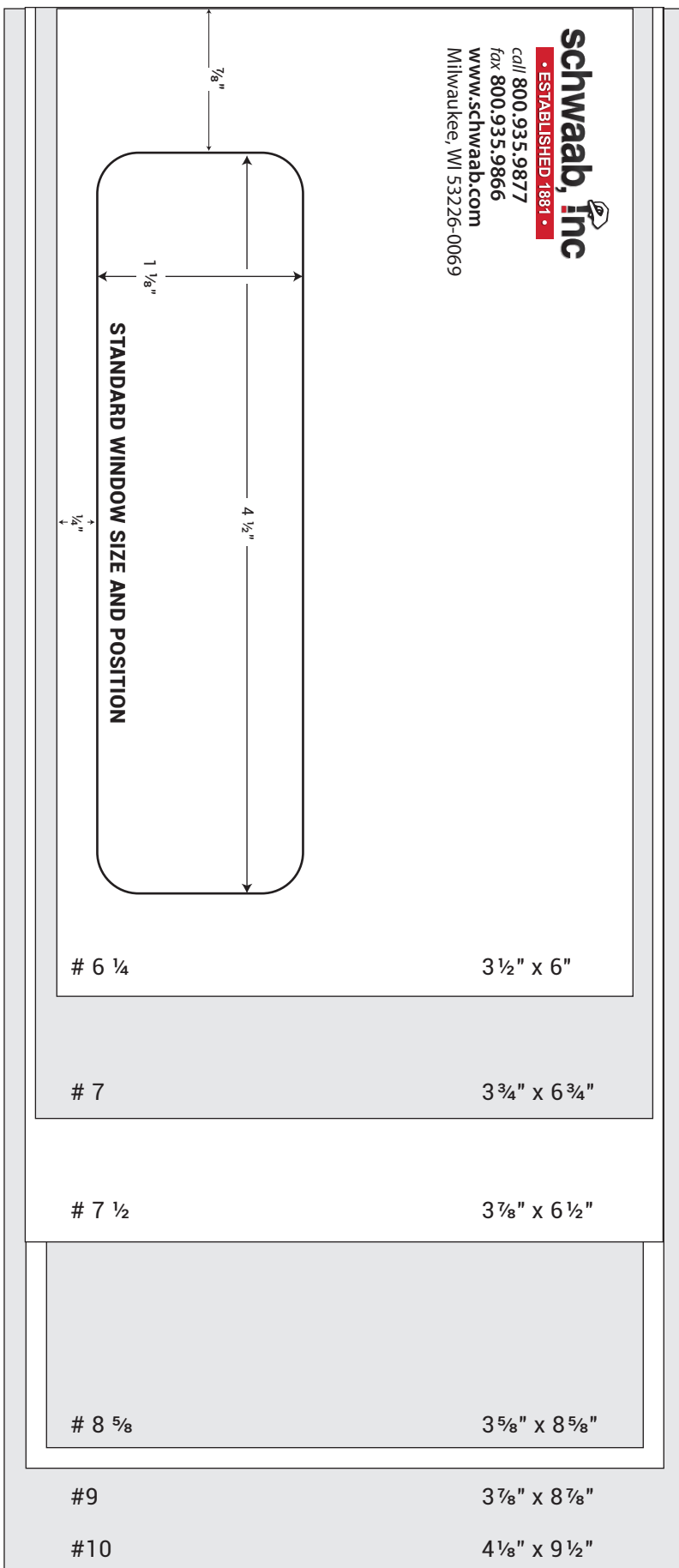

*Print Options*

- Your choice of raised print, laser-safe raised print or vibrant full color printing.

*Sizes*

- #6 1/4      • #8 5/8      • #10 Window
- #7      • #9      • #10 Security Window
- #7 1/2      • #10      • 9" x 12" Catalog

*Paper Stocks + Pricing*

- Please contact us for paper stock and pricing.

*Security Options*

- Security tint envelopes are available on request.

*Seal Options*

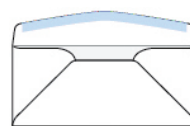

**Re-moistening Seal:**

A gum seal activated by moistening the flap for a permanent seal.

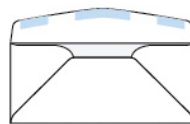

**Split Seal:**

A gum seal split into sections and activated by moistening the flap for a permanent seal; better for storing envelopes in humid conditions.

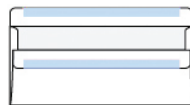

**Flip-Stik Seal:**

Latex adhesive applied on two flap surfaces and folded to keep them separated until sealing; no moisture required.

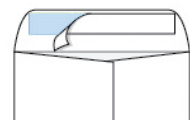

**Kwik-Tak:**

Release tape liner applied over a resin adhesive. Remove liner and press flap down to seal; no moisture required.

# CUSTOM PRINTED LETTERHEAD

Highlight your brand with every letter!

- Our 8½" x 11" letterhead is the ideal way to promote your business and brand awareness. In addition to correspondence, your letterhead can be used for invoices, proposals, statements, business forms and so much more.

## Print Options

- Your choice of raised print, laser-safe raised print or vibrant full color printing.

## Size

- 8½" x 11"

## Bleed

- Bleeds are not available.



Envelopes & Letterhead:  
**Contact Us**  
for paper stock and pricing

# STOCK BUSINESS FORMS

Choose from a variety of stock business forms that can be customized with your company information. Contact us for details on additional forms not shown.

## Form Options

- Custom Carbonless Paper
- Invoices and Receipt Books
- Sales and Register Forms
- Purchase Orders
- Service and Repair Forms
- Work Orders
- Medical Forms
- Checks and Deposit Tickets

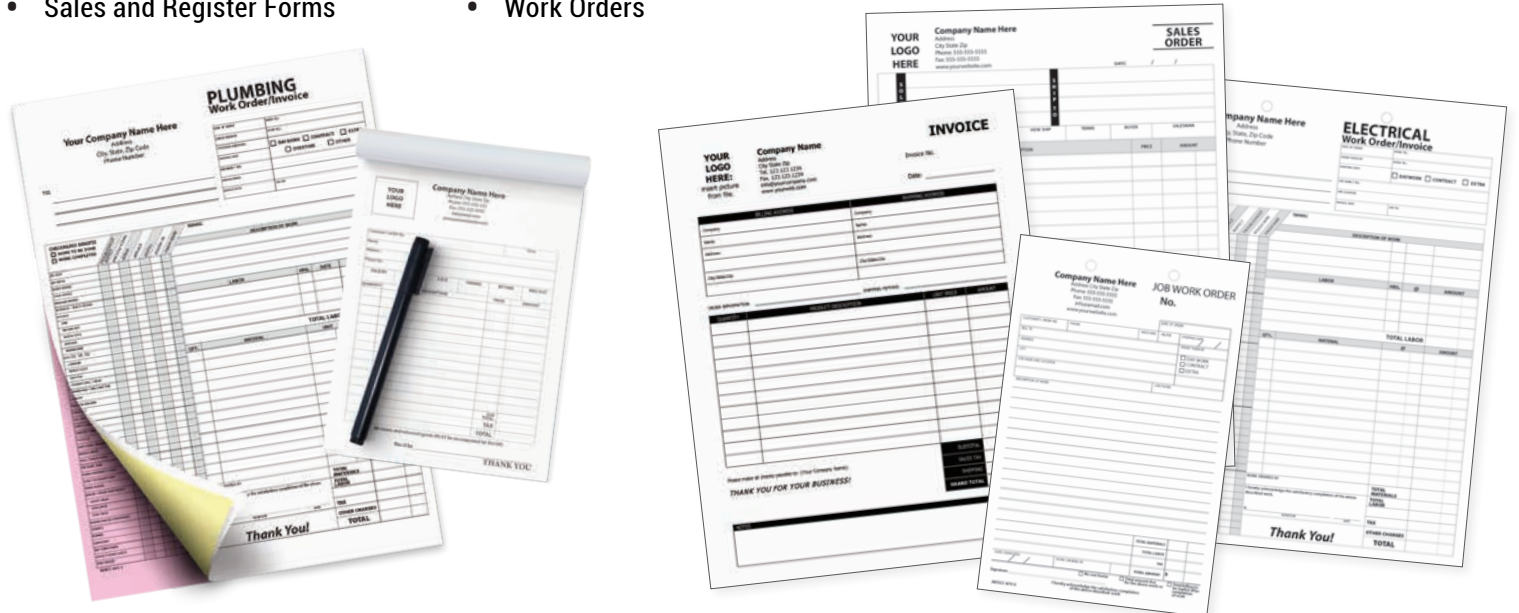

# CUSTOM BUSINESS FORMS *Can't find a stock form that meets your needs?*

Design your own form with up to two ink colors. Just contact us for details and pricing.

# POPULAR AUTOMOTIVE FORMS & VEHICLE FLOOR MATS

Designed for dealerships, body shops, or garages, our custom automotive business forms and vehicle mats are printed with your company information. Form styles include vehicle inspection forms, auto repair forms, auto parts order forms, and more.

## MULTI-POINT VEHICLE INSPECTION FORM

- Imprint Color: Black, Red, Blue, or Green
- Size: 8½" x 11"
- Imprint Area: 1" x 8"
- Forms are top edge glued.
- Imprint just your company information or add logos of your choice.
- Paper Type: Carbonless



Item #	Parts
MPV-2	2
MPV-3	3
MPV-4	4

## AUTOMOTIVE REPAIR ORDER STYLE 667

- Imprint Color: Black, Red, Blue, or Green
- Size: 11" x 8½"
- Imprint Area: 1" x 4"
- Includes drill holes and 6 digit consecutive numbering.
- Snap-a-Part Edge
- Paper Type: Carbonless

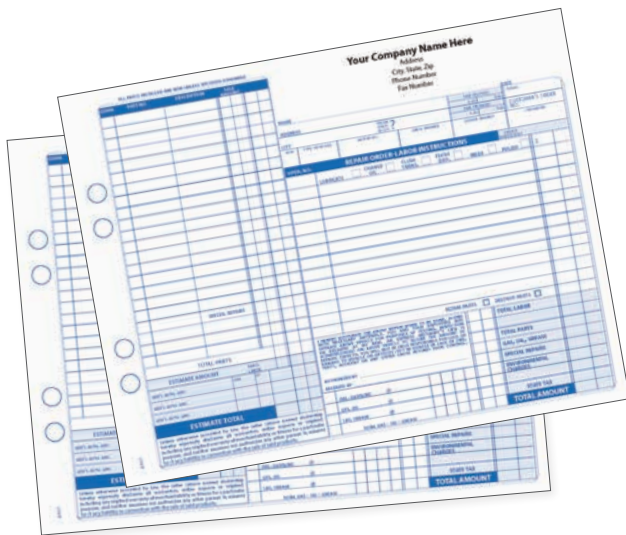

Item #	Parts	Imprint
ARO1	3	Custom
ARO1-B	3	Blank

## AUTOMOTIVE REPAIR ORDER STYLE 624

- Imprint Color: Black, Red, Blue, or Green
- Size: 11" x 8½"
- Imprint Area: 1" x 4"
- Includes drill holes and 6 digit consecutive numbering.
- Snap-a-Part Edge
- Paper Type: Carbonless

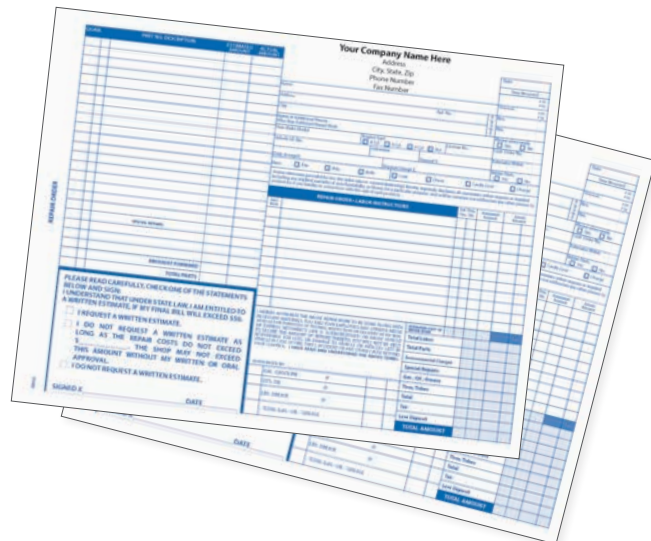

Item #	Parts	Imprint
ARO2	3	Custom
ARO2-B	3	Blank



# AUTOMOTIVE REPAIR ORDER STYLE 685

- Imprint Color: Black, Red, Blue, or Green
- Size: 11" x 8½"
- Imprint Area: 1" x 4"
- Includes drill holes and 6 digit consecutive numbering.
- Snap-a-Part Edge
- Paper Type: Carbonless

Item #	Parts	Imprint
ARO3	3	Custom
ARO3-B	3	Blank

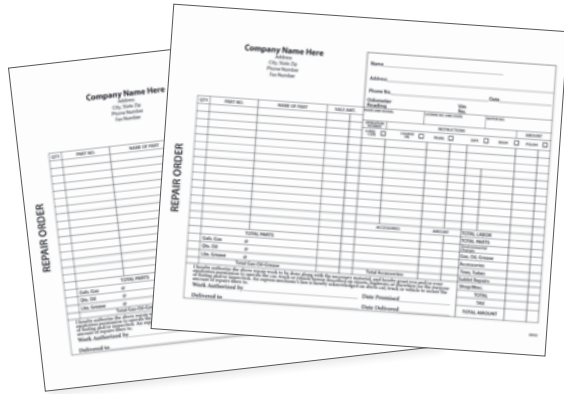
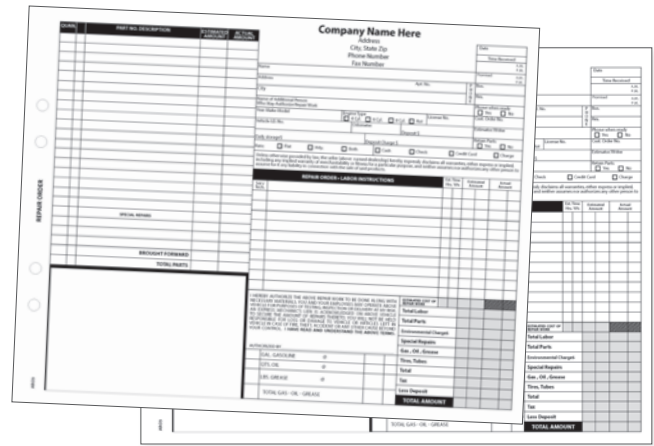

# AUTOMOTIVE REPAIR ORDER STYLE 600

- Imprint Color: Black, Red, Blue, or Green
- Size: 8½" x 7"
- Imprint Area: 1" x 3"
- Includes drill holes and 6 digit consecutive numbering.
- Snap-a-Part Edge
- Paper Type: Carbonless

Item #	Parts	Imprint
ARO4	3	Custom
ARO4-B	3	Blank

# VEHICLE FLOOR MATS

- All floor mats are printed on 24lb. bond paper.
- Design Color: Red or Blue
- Imprint Color: Black
- Deduct 30% for blank floor mats.

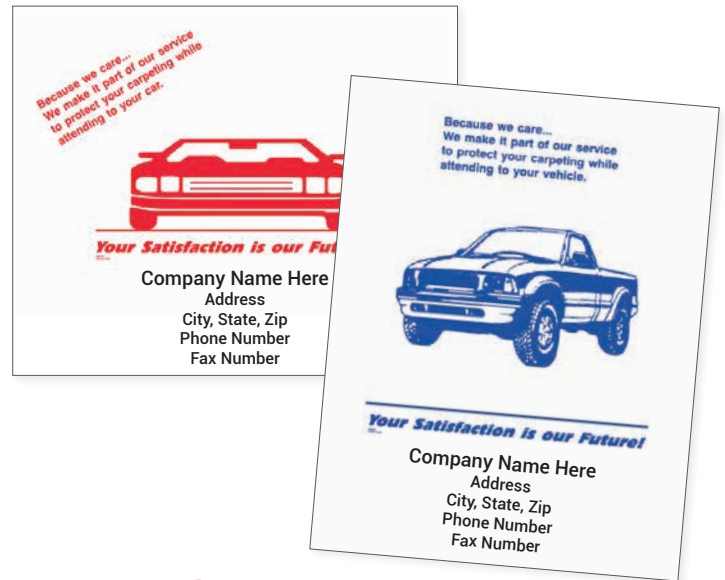

## Footprints Design

Item #	Vehicle Type	Size	Imprint
VFM-A1	Car	20" x 14"	3" x 6"
VFM-A2	Car	19" x 17"	3" x 6"
VFM-A3	Car	22" x 17"	4" x 7¼"
VFM-C	Truck	17" x 22"	3¼" x 15"

## Car + Truck Design

Item #	Vehicle Type	Size	Imprint
VFM-B1	Car	20" x 14"	3¼" x 13"
VFM-B2	Car	19" x 17"	3¼" x 12"
VFM-B3	Car	22" x 17"	3¼" x 15"
VFM-D	Truck	17" x 22"	3¼" x 15"

# Custom Magnets

Personalized with your services and contact information, magnets are an effective marketing tool that keeps selling long after other products have been tossed away or forgotten.

## MATERIAL:

Premium, 25 mil thickness with laminated finish. Contact us for Economy options.

## IMPRINT METHOD:

Full color process.

## ALSO AVAILABLE:

Economy 20 mil magnets and custom and stock shapes. Contact us for details.

## BUSINESS CARD SIZE

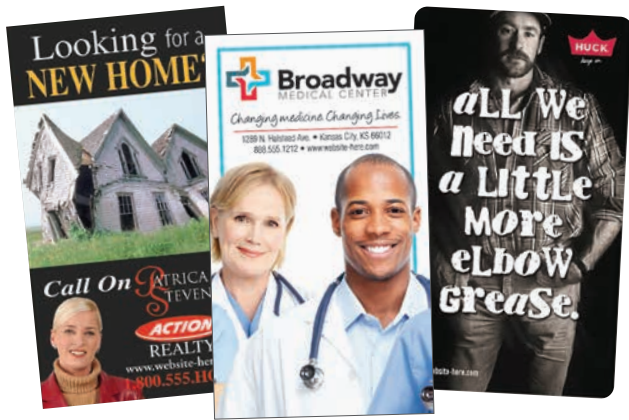

### 2" x 3 1/2" Rounded Corner Magnet

- Item: MAG23R



### 2" x 3 1/2" Square Corner Magnet

- Item: MAG23S



### 3 1/2" x 4" Rounded Corner Magnet

- Item: MAG34R



### 4" x 7" Rounded Corner Magnet

- Item: MAG47R

# Custom Magnets

## SPORT SCHEDULE MAGNETS

- Stock sports schedules for all of your favorite teams!
- Baseball, Football, Basketball, Hockey, Golf, Soccer and Nascar options available.



## SPORTS SCHEDULE LAMINATED CARD/POSTCARD WITH MAGNET STRIP

- These postcards are UV-Coated on one side with one 3" x 1", 12 mil. magnet attached to the back.
- Size: 3 1/2" x 8 1/2"
- Item can be mailed.

Item #	Description
830033	Laminated Sports Schedule Magnet

## MAGNA-CARD SPORTS SCHEDULE MAGNETS

- Take a Magnetic Business Card Magnet, add a schedule and you have a Sport Schedule Magna-Card!
- Size: 3 1/2" x 9"
- Schedule includes stock sport schedule of your choice.
- Magnet Live Imprint Area: 3.375" x 1.875"



Item #	Description
MAGFB2	Football Magna-Card
MAGBB2	Baseball Magna-Card
MAGNC2	Racing Magna-Card
MAGSC2	Soccer Magna-Card
MAGGF2	Golf Magna-Card

## M.B.C. SPORT SCHEDULES + CALENDAR MAGNETS

Personalize with your business card!

- Includes the stock sports schedule or calendar of your choice.
- Printed on 10 point paper and UV-coated.
- Size: 3 1/2" x 9"
- Simply peel off the liner and apply your business card to the adhesive.

## M.B.C. CALENDAR MAGNET

- \*Must be ordered in increments of 100

Item #	Description
47001U-style	Calendar Magnet



## M.B.C. SPORTS SCHEDULE MAGNET

Item #	Description
MAGFB5	Football Schedule Magnet
MAGBB2	Baseball Schedule Magnet
470233	Hockey Schedule Magnet
470633	Golf Schedule Magnet
470933	Soccer Schedule Magnet

# Custom Car Magnets + Sticky Notes

## CAR MAGNETS

Car magnets can be personalized with your services and contact information for an effective marketing tool. Our car magnets are weather resistant, durable, flexible and removable. Magnet is 30 mil magnet-backed vinyl with rounded corners.



Item #	Size
MAG918	9" x 18"
MAG824	8" x 24"
MAG1212	12" x 12"
MAG1218	12" x 18"
MAG1224	12" x 24"
MAG1824	18" x 24"
MAG2424	24" x 24"

## STICKY NOTES

Everybody uses Sticky Notes! Ideal for grocery lists, notes, messages, reminders, and more.

- Note pad paper is 50 lb. offset.
- Sizes: 3" x 3", 4" x 3", 5" x 3"
- Available in 20 or 50 sheets per pad.
- Padded on the longest side only.
- We do not recommend print or type smaller than 8 pt.

Item #	Size	Sheets/Pad
SP3325	3" x 3"	25
SP3350	3" x 3"	50
SP4325	4" x 3"	25
SP4350	4" x 3"	50
SP5325	5" x 3"	25
SP5350	5" x 3"	50

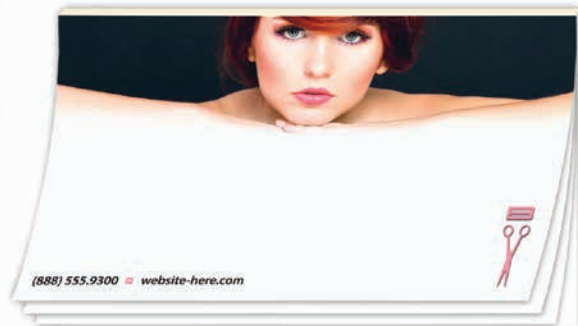

# Custom Can Coolers + Tumblers

## COLLAPSIBLE CAN COOLER

- Item: FZCC1
- Cooler Colors: See samples below
- Product Size: 5 1/4" H x 3 7/8" W
- Imprint Colors: One Color
- Imprint Locations: Front, Back
- Imprint Area: 3" x 3"
- Set Up Charge \$50.00



## COLLAPSIBLE CAN COOLER

Full Color Sublimation by RealColor360

- Item: FZCCRC
- Cooler Colors: See samples below
- Product Size: 5 1/4" H x 3 7/8" W
- Imprint Colors: Multiple, Full Color
- Imprint Locations: Front, Back, Bottom
- Imprint Area: Full 360° Impression Area
- Set Up Charge \$55.00



## CUSTOM TUMBLERS

- Item: TMBLR
- 30 oz Tumbler customizable with text and/or images.
- Tumblers are made with durable kitchen-grade white stainless steel and feature a double-wall vacuum for insulation that keeps drinks cold or hot, down to the last drop!
- BPA Free.

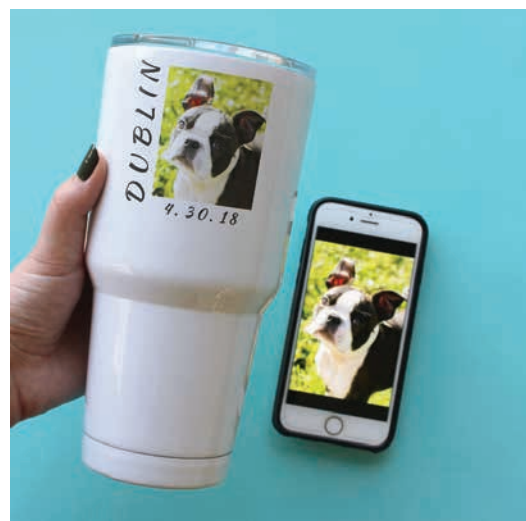

# License Plate Inserts + Frames

## SILKSCREEN PLASTIC LICENSE PLATE FRAME

- Item: LPF5
- High Impact Polystyrene Plastic.
- Frame Colors: Black, Reflex Blue, Dark Blue, Yellow, White
- Imprint: Up to 4 Colors
- Frame Style: 1, 5, 6



Color Options	Set Up Charge
1 Color Imprint	\$55.00
2 Color Imprint	\$110.00
3 Color Imprint	\$165.00
4 Color Imprint	\$220.00

## RAISED PLASTIC LICENSE PLATE FRAME

- Item: RLPFP
- High Impact Polystyrene Plastic.
- Raised copy creates a three-dimensional appearance.
- Product Colors: Black, Reflex Blue, Dark Blue, Red, Gray, White
- Imprint: 1 or 2 Colors
- Frame Styles: 1-5



Color Options	Set Up Charge
1 Color Imprint	\$115.00
2 Color Imprint	\$170.00
3 Color Imprint	\$225.00
4 Color Imprint	\$280.00

## SILKSCREEN LICENSE PLATE

- Item: PLP20
- 25 mil Styrene
- Product Color: White
- Imprint Colors: Maximum 4-colors
- Full bleed is not available, 1/2" white border.
- Holes: 4



Color Options	Set Up Charge
1 Color Imprint	\$55.00
2 Color Imprint	\$110.00
3 Color Imprint	\$165.00
4 Color Imprint	\$220.00

## IMPRINT COLORS



## FRAME STYLES



# Custom Key Tags

## FLASHLIGHT KEY CHAIN

### Super Bright LED Flashlight with Swivel Split Keychain

- Item: FL1076
- Product Size: 1/2" x 2 3/4"
- Imprint Size: 5/16" x 1"
- Solid metal construction and metallic color finish with 5 beams.
- 4 replaceable LR44 cell button batteries included.
- Imprint Options: Pad Printing or Laser Engraving.



- Imprint Colors: PMS match or select color from guide.

### IMPRINT COLORS



#### Imprint Type    Set Up Charge

Blank	
1 Color	\$50.00



## STANDARD OVAL KEY TAG

### Full Color, Soft Vinyl, Standard Oval Key Tag

- Item: 2000KT
- Piece Size: 1 7/8" x 2 1/8"
- Imprint Size: 1 1/4" x 2"
- Ring Diameter: Standard 1.1"



- Imprint Colors: Digital 4-Color Process. (exact PMS colors not available, will simulate as close as possible)

#### Imprint Type    Set Up Charge

1 Side Imprint	\$38.00
2 Side Imprint	\$38.00

## SPOT COLOR ROUND KEY TAG

### Spot Color, Soft Vinyl Small Round Key Tag with Tab

- Item: 6318KT
- Piece Size: 1 1/2" Diameter
- Imprint Size: 1 3/8" Diameter
- Imprint: 1 Color
- Imprint Colors: Any spot color
- Material Color: See guide for options



### MATERIAL COLORS

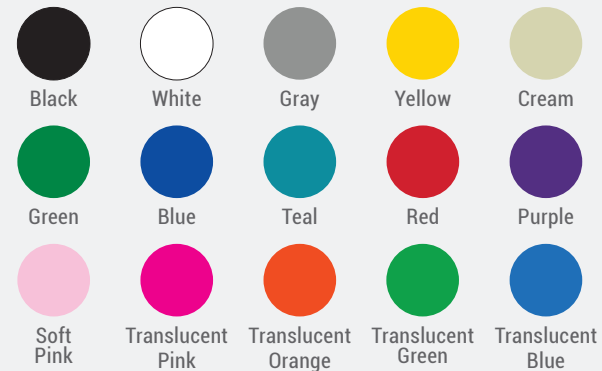

#### Imprint Type    Set Up Charge

1 Side Imprint	\$38.00
2 Side Imprint	\$38.00

**JAVALINA Click Action Pen**

- Item: 322PN
- Material: Plastic
- Mechanism: Push Retractable
- Tip Type: Ballpoint
- Writing Color: Black, Blue
- Imprint Size: 1 1/2" x 3/4"
- Product Color: Red, Black, Green, Blue
- Imprint: 1 Color, 2 Colors, Full Color



**PARADISO Click Action Pen**

- Item: 379PN
- Material: Plastic
- Mechanism: Push Retractable
- Tip Type: Ballpoint
- Writing Color: Black
- Imprint: 1 Color, 2 Colors, Full Color
- Imprint Size: 1 7/8" x 1/2"
- Product Color: Blue, Lime Green, Red, Orange

**MARDI GRAS Click Action Pen**

- Item: 411PN
- Material: Plastic
- Mechanism: Push Retractable
- Tip Type: Ballpoint
- Writing Color: Black, Blue
- Imprint: 1 Color, 2 Colors, Full Color
- Imprint Size: 1 7/8" x 1/2"
- Product Color: Yellow, Blue, Purple, Teal, White, Black, Red





## CALYPSO Click Action Pen

- Item: 358PN
- Material: Plastic
- Mechanism: Push Retractable
- Tip Type: Ballpoint
- Writing Color: Black
- Product Color: Cobalt Blue, Neon Yellow, Hot Pink, Lime Green, Bright Orange
- Imprint: 1 Color, 2 Colors
- Imprint Colors: Black, Silver
- Imprint Size: 1 5/8" x 1/2"



## ECLAIRE Bright Illuminate Stylus

- Item: 579PN
- Material: Plastic
- Mechanism: Twist
- Tip Type: Ballpoint
- Writing Color: Black
- Product Color: Ultra Violet, Lime Green, Burnt Orange, Turquoise Blue, Black
- Imprint: Laser Engraved (Clear)
- Imprint Size: 1 1/2" x 1/4"

## ST. JAMES TRIPLE FUNCTION Stylus/LED Light

- Item: 853PN
- Material: Metal
- Mechanism: Push Retractable
- Tip Type: Ballpoint
- Writing Color: Black
- Imprint: Laser Engraved (Silver)
- Imprint Size: 1 1/2" x 1/4"
- Product Color: Black, Blue, Gunmetal, Cinnamon



Personalized gifts are perfect for real estate or mortgage closings, employee awards, corporate gifts, relatives, or in remembrance of a special occasion or event. Best of all, they will last forever and will keep you on the recipient's mind with every use.

## BAMBOO CUTTING BOARDS

Add a personal touch to any home kitchen with custom cutting boards. Our custom cutting boards are laser engraved with your custom information and can include initials, monograms, names, messages, handwritten recipes or any simple design.

Personalized cutting boards are great gifts for everyone on your shopping list and are the perfect centerpiece to any gathering!

- Cutting Boards can be branded with your logo and name to get the recipient thinking of you with every use.
- Beautifully engraved to be displayed as home décor and practical enough to be used every day.
- Choose from a variety of design templates or send us your personal custom design.
- Item: 45413 | Size: 13 1/2" x 11 1/2" x 1/2"
- Item: 45419 | Size: 11" x 8 7/8" x 1/2"



### Imprint Options: Bamboo Cutting Boards



G12

Your Own Custom Design

G29



G24



G25



G26



G27



G28



## PERSONAL SERIES ADDRESS STAMP

Grow your Referral Business Today with address stamps from Schwaab!

- Item: 42S824
- Custom made to make lasting impressions.
- Branded with your contact information for long term advertising.
- Gets your clients thinking of you with every use.
- Useful gift that your client will keep and use on a regular basis.
- No artwork fees.
- Includes a Thank You presentation gift box.
- Ink colors: Black, Red, Blue

## POPULAR PHOTO IDEAS:

Holidays, Weddings, Anniversaries, Graduations, Retirements, Vacations, Sporting and Leisure Events, Special Occasions and Parties, New Homes, Landmarks

## OTHER IDEAS:

Take a photo of hand drawn sketches, kid's art projects and drawings, arts & crafts projects and more

## WINE & CHEESE 5-PIECE TOOL SET

Turn your favorite photo memories or custom designs into a unique wine and cheese set for a gift that will be cherished forever! This beautiful set features a solid wood case with a full-color imprinted gas cutting board.

Custom wine and cheese sets are an ideal way to commemorate any special occasion, make great gifts and are the perfect centerpiece to any gathering!

- Item: GFT515
- Cutting boards can be branded with your logo and a custom message to get the recipient thinking of you with every use.
- Includes a glass cutting board, corkscrew, wine stopper, cheese knife/spreader, cheese fork and drip stop collar.
- No set-up fees or minimum order quantities.
- Size: 5½" x 13½"



## PHOTO GLASS CUTTING BOARDS

Turn your favorite photo memories or custom designs into a unique glass cutting board for a gift that will make lasting relationships and be cherished forever!

- Item: SBL075
- Cutting boards can be branded with your logo and a custom message.
- No set-up fees or minimum order quantities
- These beautiful boards can be displayed as home décor & practical enough to be used every day.
- Size: 7¾" x 11¼"

## PHOTO SERVING TRAY

Get your full-color custom design or photo imprinted onto a beautiful serving tray to have on display for years to come!

- Item: UN5672
- Size: 13¼" x 8¾" x 2¾"





Single Wine Presentation Box

Martini Set

Wine Tool Set

**These elegant rosewood finish presentation boxes are laser engraved and filled with your choice of Silver or Gold paint.**

**Beautifully engraved to be displayed as home décor!**

## ROSEWOOD FINISH SINGLE WINE PRESENTATION BOX

- Item: 45411
- Presentation boxes can be engraved with your corporate logo and name to get the recipient thinking of you with every use.
- Holds a 750 ml. bottle of wine (not included).
- Includes 4 wine tools.
- Rosewood box is silk lined.
- Size: 14 1/4" x 4 1/4" x 4 5/8"
- Your price includes a laser engraved design, company logo and custom message.

## ROSEWOOD FINISH MARTINI SET

- Item: 45411
- Includes: Shaker, Strainer, Tongs, Jigger and Stirrer
- Size: 11 5/8" x 10 5/8" x 4"
- Your choice of Gold or Silver Imprint.

## ROSEWOOD FINISH 5-PIECE WINE TOOL SET

- Item: WTL02
- Includes: Corkscrew, Wine Pourer, Drip Stop Collar, Wine Stopper and Foil Cutter.
- Size: 10 3/4" x 8 3/4" x 2 3/4"
- Your choice of Gold or Silver Imprint.

# Imprint Options: Single Wine Bottle Presentation Box

G40-1



G41-1



G42-1



G43-1



G44-1



G45-1



G46-1



G47-1

**Your Own Custom Design**

# Imprint Options: Martini Set + Wine Tool Set

- M** Applies to Martini Set
- W** Applies to Wine Tool Set

G11-3

**W**



G11-3

**M**



G16-3

**W M**



G40-3

**M**



G41-3

**W M**



G42-3

**W M**



G43-3

**W M**



G44-3

**W M**



G45-3

**W**



G46-3

**W**



G47-3

**W M**

**Your Own Custom Design**

# Acrylic Protection Barriers

PROVIDE ADDITIONAL SAFEGUARDS WITH OUR PROTECTION BARRIERS! THESE CLEAR ACRYLIC BARRIERS ARE AN IDEAL WAY TO LOWER THE RISK OF SPREADING GERMS AND VIRUSES IN ANY BUSINESS ENVIRONMENT.

*No Window* ▼



- Material: 1/8" Acrylic
- Placement: Counter or Table Top

- Use at cashier counters and windows, reception desks, teller windows and more.
- Easy to assemble, lightweight and portable!
- Options: Standard Guard or Guard with Transaction Window

▲ *With Window*



Size Width x Height	Item # No Window	Item # With Window
24" x 24"	SZG2424	SZG2424-W
30" x 24"	SZG3024	SZG3024-W
36" x 24"	SZG3624	SZG3624-W
48" x 24"	SZG4824	SZG4824-W
24" x 30"	SZG2430	SZG2430-W
24" x 36"	SZG2436	SZG2436-W



<b>BILL TO INFORMATION</b>			<b>SHIP TO INFORMATION</b> (if different than "Bill To")		
PHONE: (       )			PHONE: (       )		
COMPANY:			COMPANY:		
ATTN: (FIRST NAME)		(LAST NAME)	ATTN:		
STREET:			STREET:		
CITY:	ST:	ZIP+	CITY:	ST:	ZIP+

E-MAIL:		FAX: (       )
<b>PAYMENT METHOD</b>	<input type="checkbox"/> BILL ME <input type="checkbox"/> CHECK ENCLOSED <input type="checkbox"/> CHARGE	CARD # _____
	CHK # _____              ___ VISA    ___ MC    ___ AMEX    ___ DISC	EXP _____ SEC CODE _____

## ORDER FORM

**STAMP TYPE:** Flash Pre-Inked (F) • Pre-Inked (P) • Self-Inking (S) • Rubber (R)    **INK COLOR:** ● Black (K) • ● Red (R) • ● Blue (U) • ● Green (G) • ● Purple (P)

*\* NOTE: Flash stamp style and black ink are standard unless an alternative is specified.*

STAMP TYPE	INK COLOR	QTY	IMPRINT

SPECIAL INSTRUCTIONS:	DATE:
	CUSTOMER APPROVAL - PLEASE PRINT

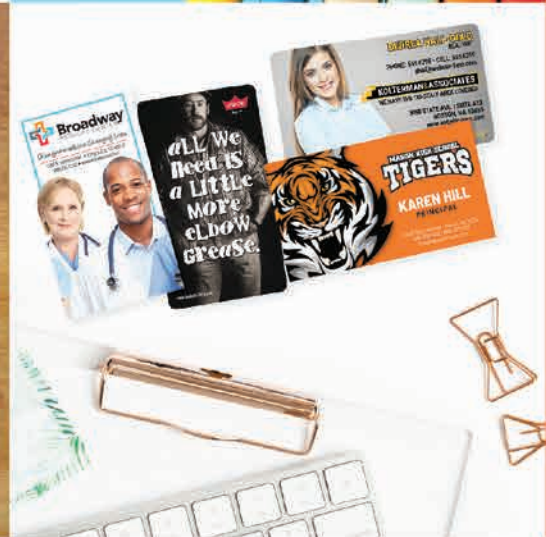
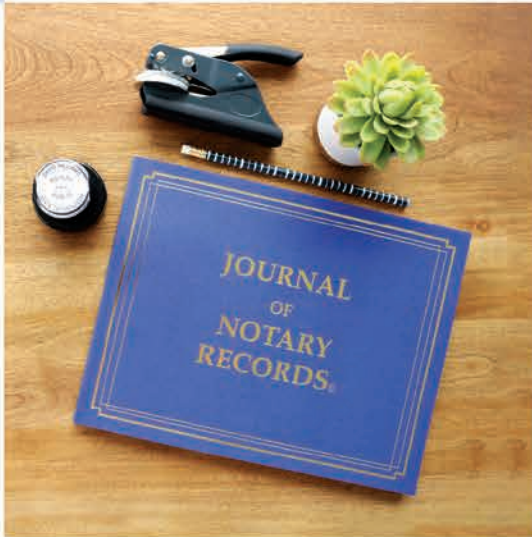

SCHWAAB, INC.  
12855 West Lisbon Road  
Brookfield, WI 53005

Phone: 800.935.9877  
Fax: 800.935.9866  
schwaab@schwaab.com  
www.schwaab.com

Follow us on social media

