

Ford Transit Connect L1 Installation Manual

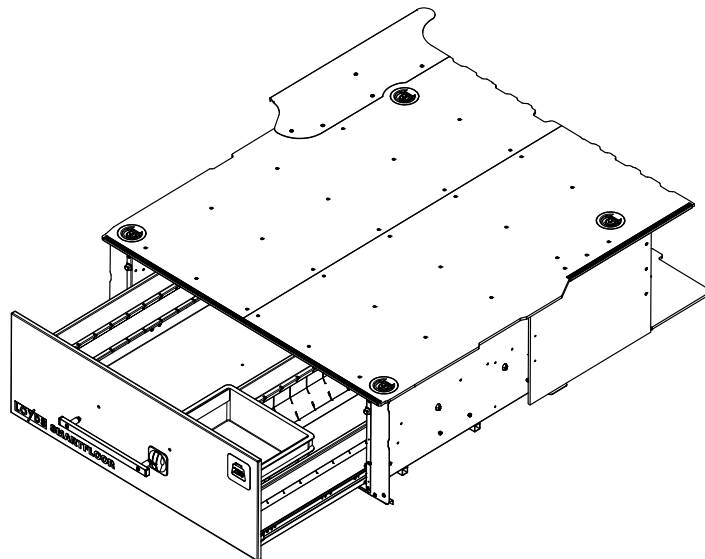

1SLD
2SLD

Tools Needed

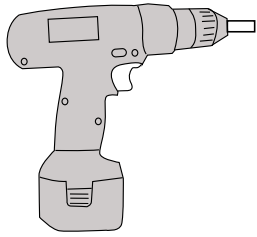

Bits
TX 25
TX 30
TX 50

Bits
PH 2

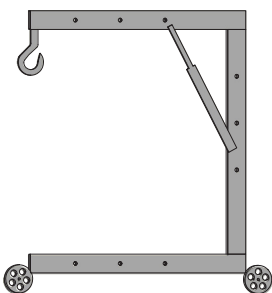
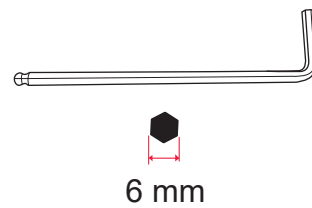
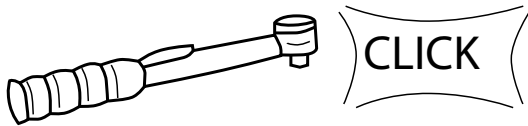
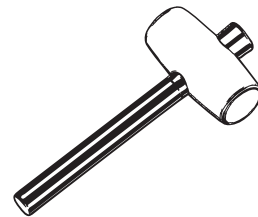
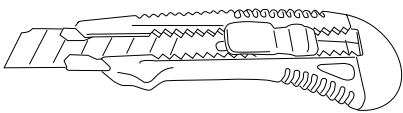
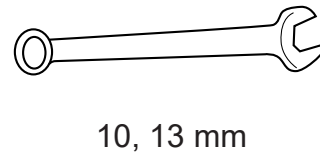
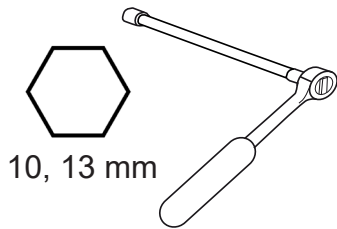
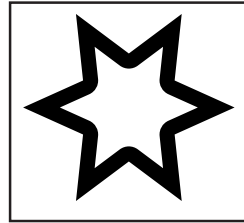

15018677_B Kit Complete Ford Connect L1 1&2SLD SF

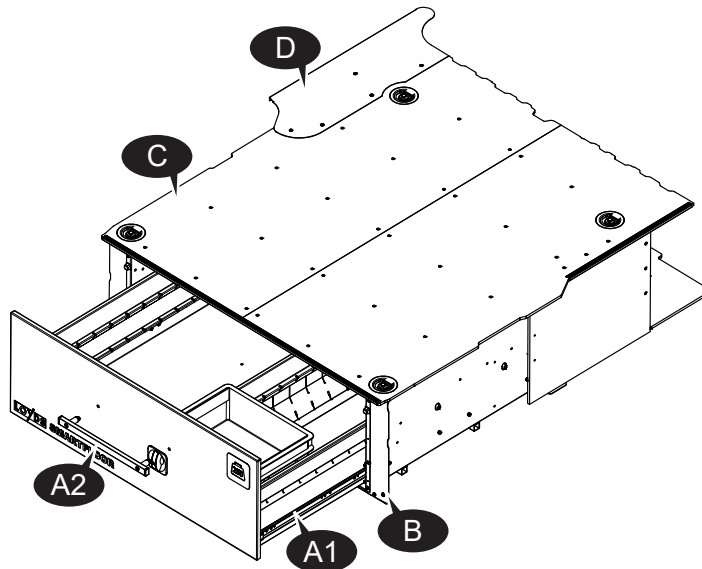

Item	Quantity	Part Number	Description
A1	1	15010859	RD Drawer 1000 1200 Main Assy
A2	1	15010236	Handle Assy
B	1	15018675	Bracket Set Ford Connect L1 2SLD
C	1	15018674	Top Floor Ford Connect L1 2SLD
D	1	15018692	Supplement Set SF for Ford Connect L1 1SLD

15010236 Handle Assy

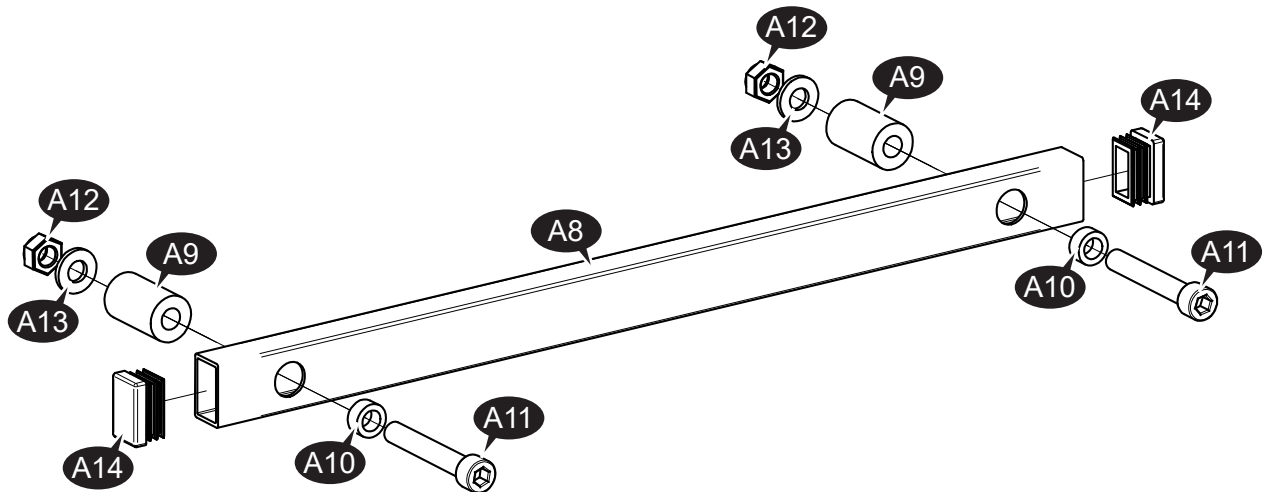

Item	Quantity	Part Number	Description
A8	1	15009441	Handle Tube 25x15x286
A9	2	15009442	Spacer Ø8,3x18x30 Nylon Black
A10	2	15009443	Spacer Ø8,1x13x6mm Galv
A11	2	15009444	Screw M8x50 Cylinderh Hex
A12	2	8 NMU	Mutter M8 Nyloc DIN985
A13	2	8,4x17x2	M8 Washer, DIN 125
A14	2	15009438	End Plug Tube 25x15 Inside

15017792_A Floor Set SF Connect L2 2SLD

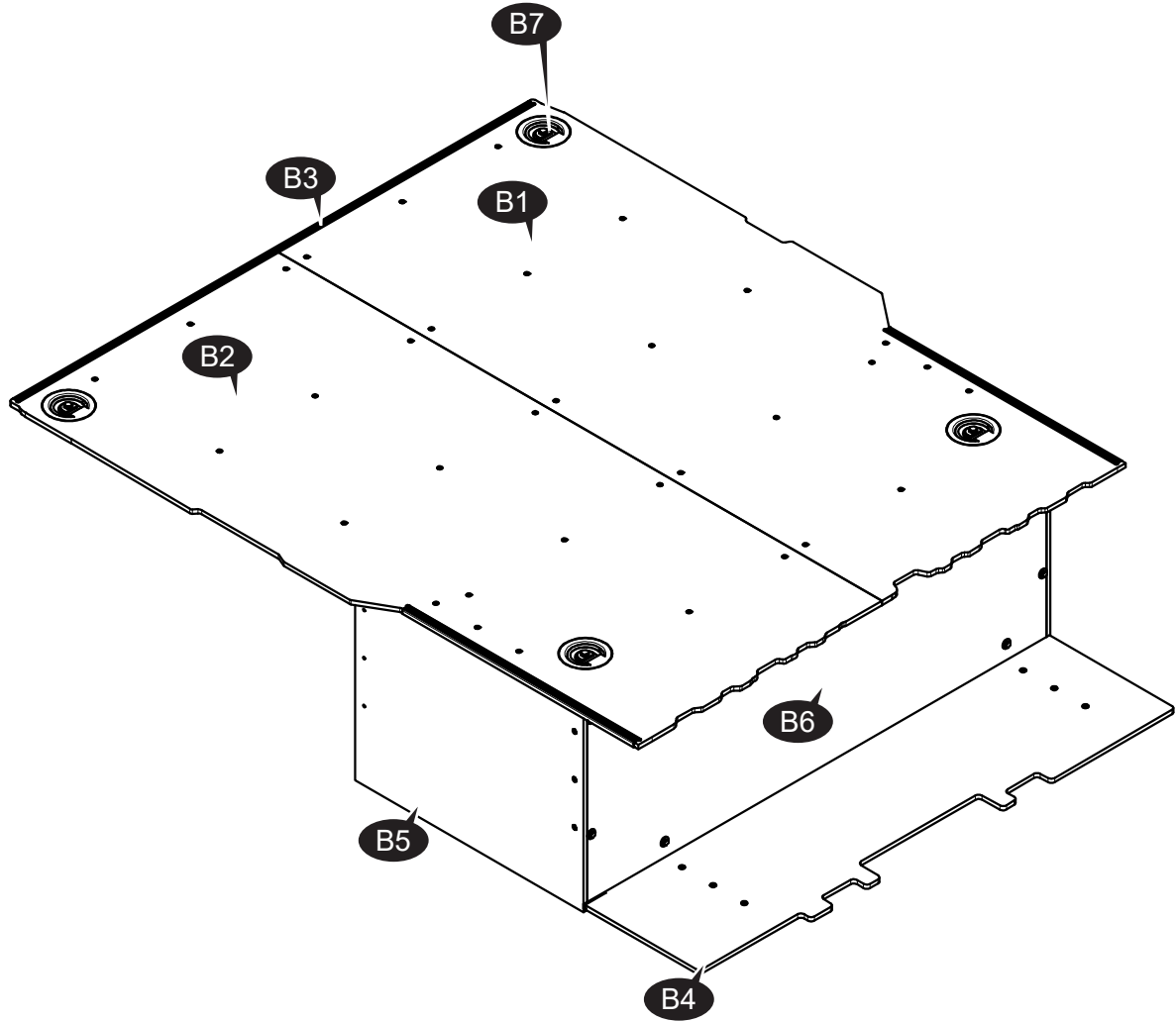

Item	Quantity	Part Number	Description
B1	1	15018671	Top Floor Left Side Ford Connect L1 ASSY
B2	1	15018672	Top Floor Right Side Ford Connect L1 ASSY
B3	1	15018511	U-Profile 9mm L=1240
B4	1	15018502	Front Floor Ford Connect L1 Hatch
B5	2	15018508	Cover Floor Ford Connect L1
B6	1	15018503	Vertical Floor Ford Connect L1
B7	1	15018673	Fitting Kit Floor Ford Connect L1

15017794_A Steelbracket Set SF Connect L2

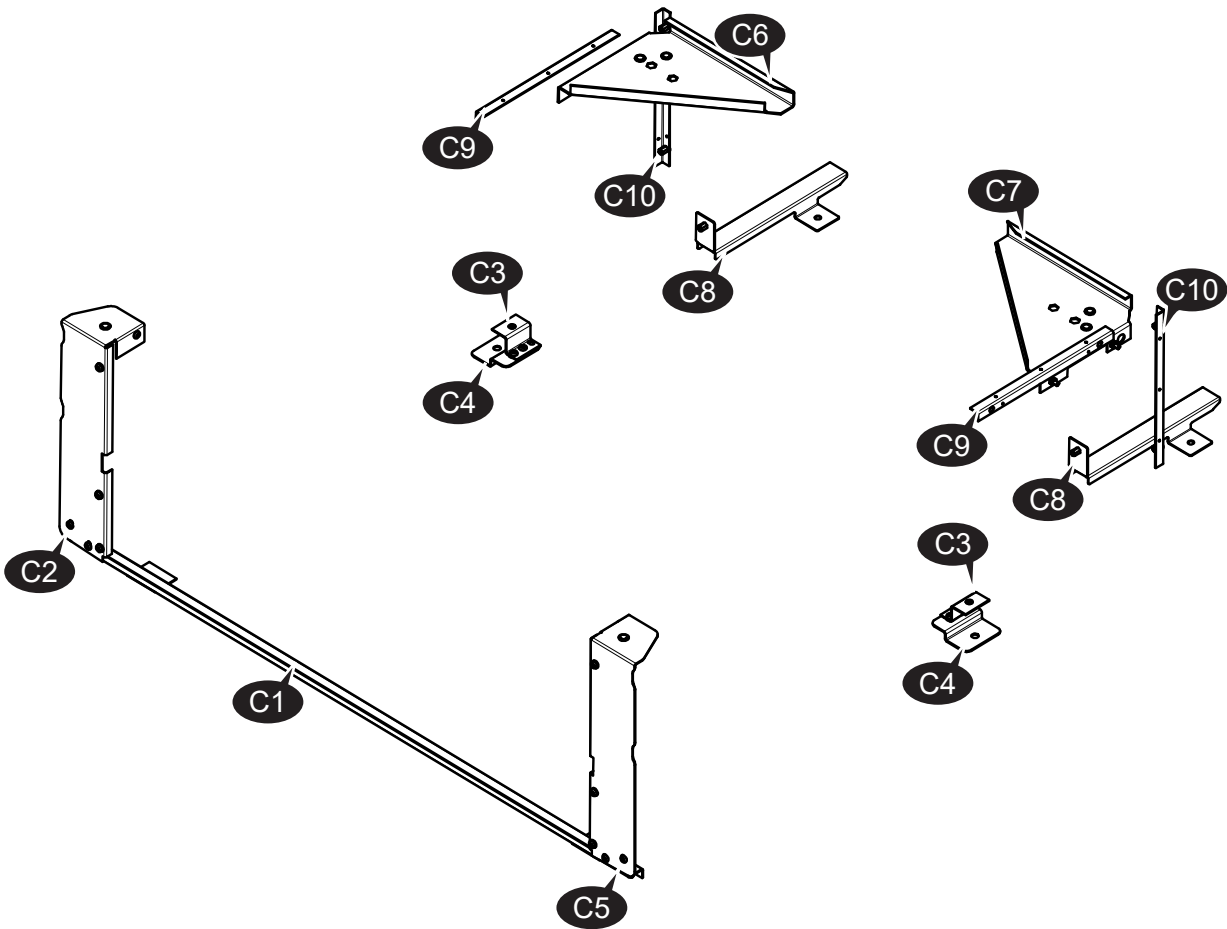

Item	Quantity	Part Number	Description
C1	1	15017766	Bracket Lower Rear SF Connect L2 ASSY
C2	1	15017773	Bracket Rear Left SF Connect 2019 ASSY
C3	2	15017769	Bracket Middle Upper SF Connect
C4	2	15017768	Bracket Middle Lower SF Connect
C5	1	15017775	Bracket Rear Right SF Connect 2019 ASSY
C6	1	15011031	Bracket Latchcup M8 Multi Right ASSY
C7	1	15011032	Bracket Latchcup M8 Multi Left ASSY
C8	2	15018509	Front Bracket Ford Connect L1 ASSY
C9	2	15018504	Front Bracket for Floor Fixate Ford Connect L1
C10	2	15018507	Front Bracket for Floor Fixate Ford Connect ASSY
	1	15018678	Fitting Kit Bracket Set Ford Connect L1

15018692_A Supplement Set SF for Connect L1 1SLD

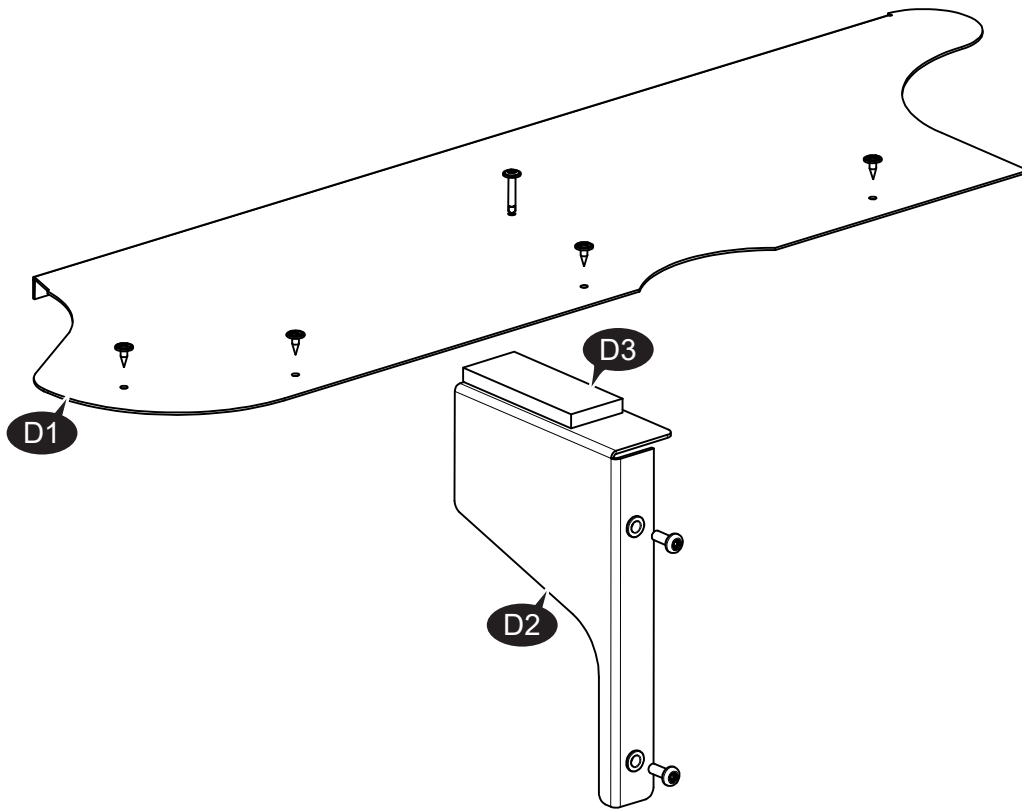

Item	Quantity	Part Number	Description
D1	1	15018679	Hatch Ford Connect L1
D2	1	15010225	Bracket Stiffner Middle Right T5 w heater ASSY
D3	1	15018691	Fitting Kit Supplement Set SF Connect L1 1SLD

15018673_A Fitting Kit Floor Connect L1

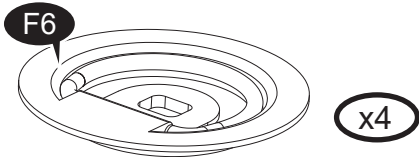

15005497
Latch Cup Black Ø90 Ø12x15 1000Kp

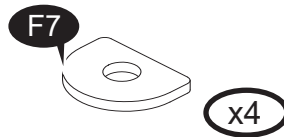

15005884
Washer Latchcup for Ø8

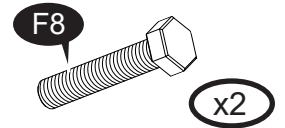

8x40 6KS
M8x40mm Bolt, DIN 933, sort

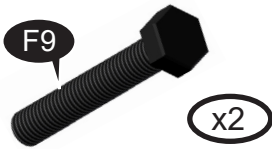

15004713
M8x50mm Bolt, 6K DIN 933 Black

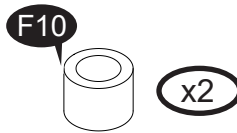

15001584
Distansehylse D20 d13 h15

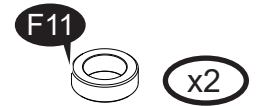

13x20x6,4
Spacer, U-709

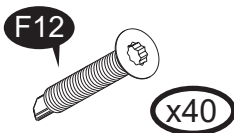

15016947
Screw 4,8x25 Selfdrill Counters Torx
Elz



225 085 6516
Gummikloss 12x12x5 sort m tape

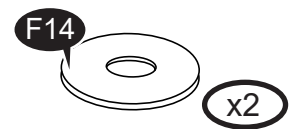

6,4x18x1,5
M6 Washer, DIN 9021

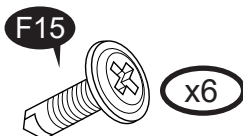

4,2x19 FL
Screw Selfdrill flath elz

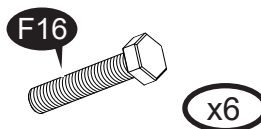

6x30 6KS
M6x30mm Bolt, DIN 933, sort

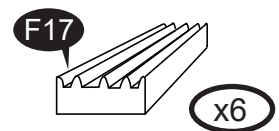

36.721004
Window Rubber Profile L=1120

15018676 Fitting Kit Bracket Set Ford Connect L1

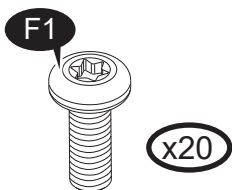

15003551
M6x16 TX30 pan (DIN 7985)



6 NMU
M6 Self Locking nut, DIN 985-8



4,2x16 FL
Screw Selfdrill flat elz

15018691 Fitting Kit Supplement Set SF Connect L1 1SLD

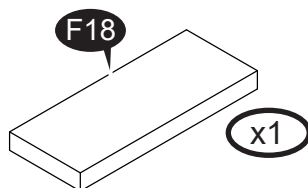

05-99406
Avstandskloss 10x40x100

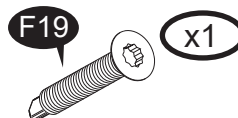

15012298
4,2x32 Screw Selfdrill flat elz

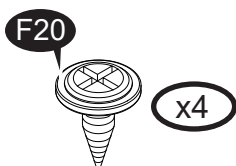

4,2x13 S
Screw 4,2x13 Flathead Needle Black

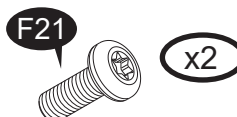

15003551
M6x16 TX30 Pan (DIN 7985)



= Keep the part for later use



= Part is no longer needed



= Use a part that has been dismantled earlier

Recommended torque for screws:

6mm:	6 NM
8mm:	10 NM
10mm:	42 NM

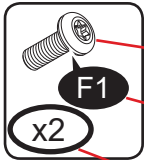

- Illustration of part

- Reference to parts list

- Necessary quantity of parts at the current step

Orientation Symbols

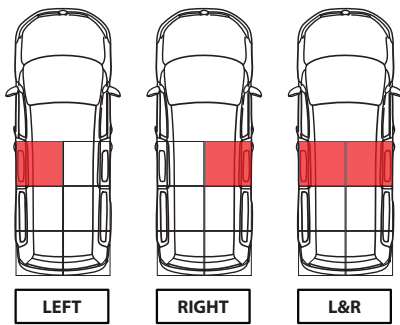

Front

L&R (Left and Right) indicates that the assembly is equal or close to equal on both sides.

1SLD = One sliding door
2SLD = Two sliding doors

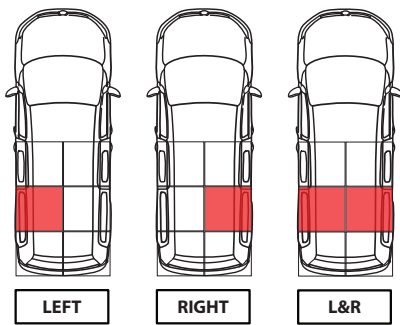

Middle



Arrow indicates witch direction a bolt should be mounted

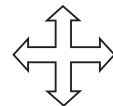

Adjust gaps around part

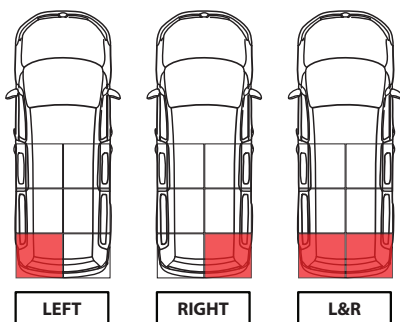

Rear



Lubricate threads if the friction is high, to achive the right torque

1.

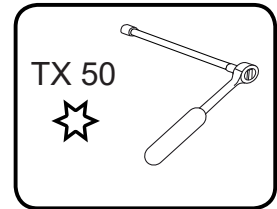
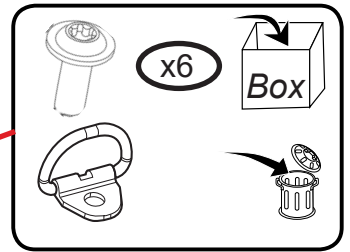

2.

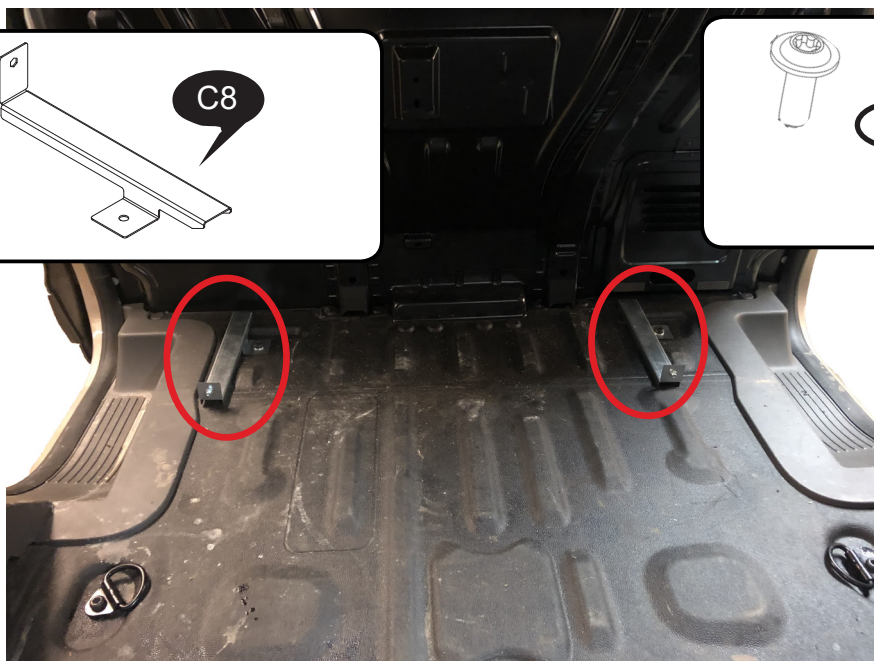
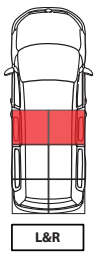
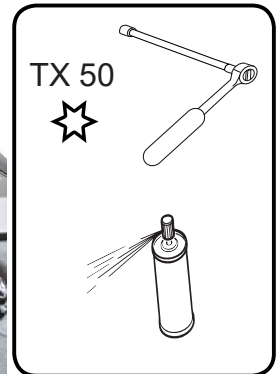
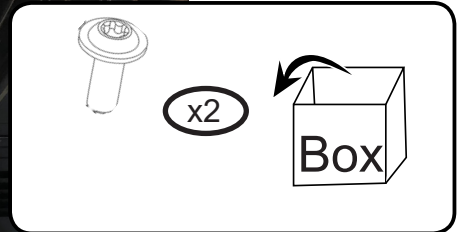
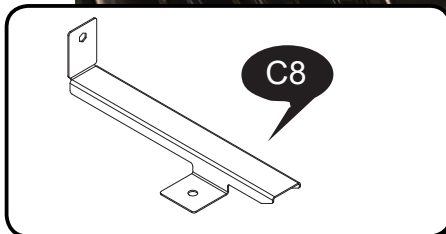

3.

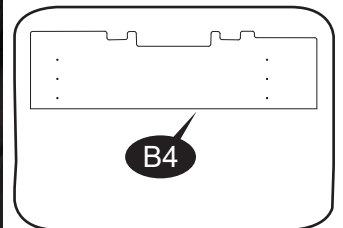
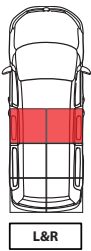

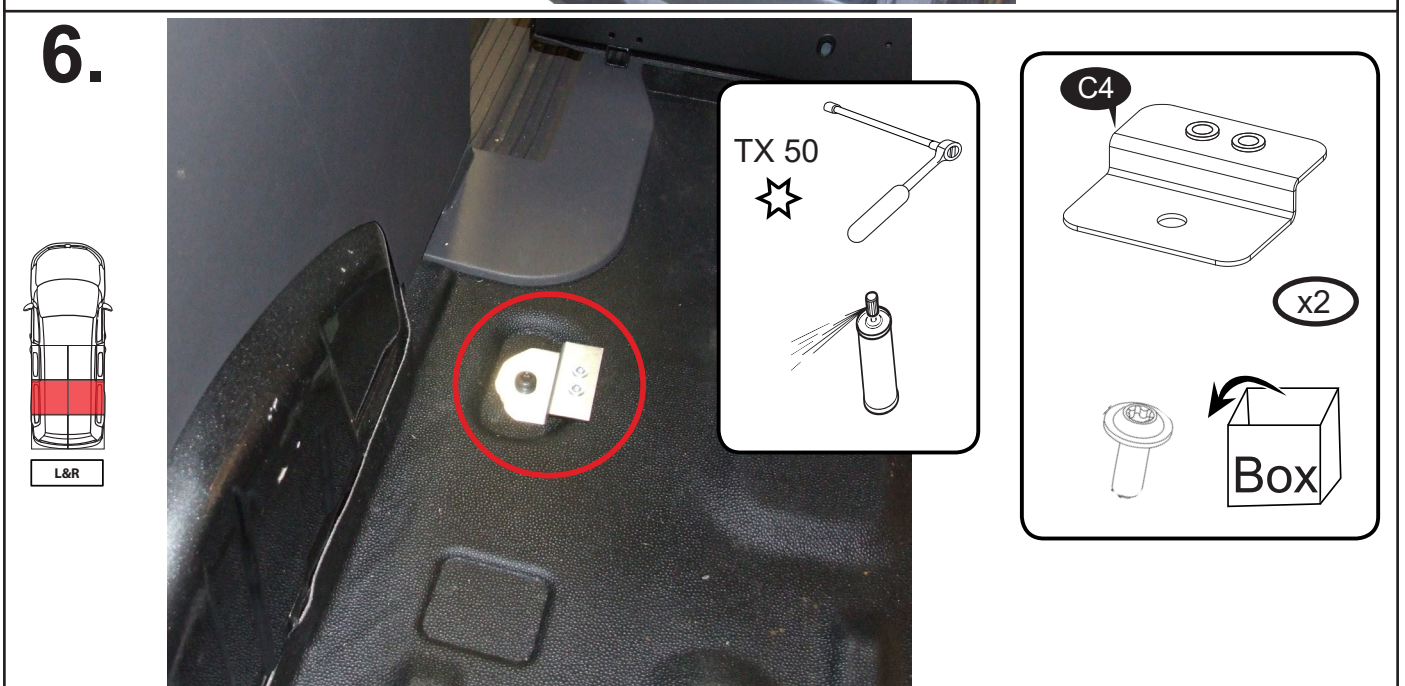
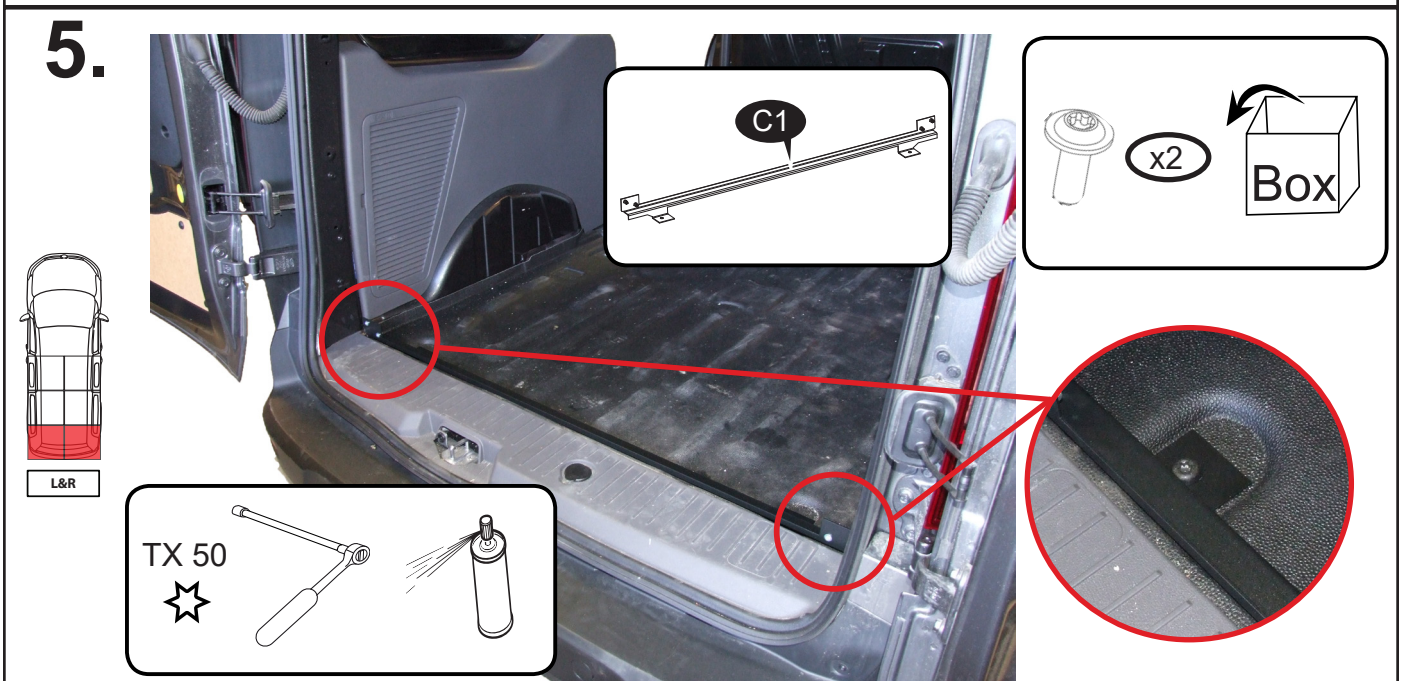
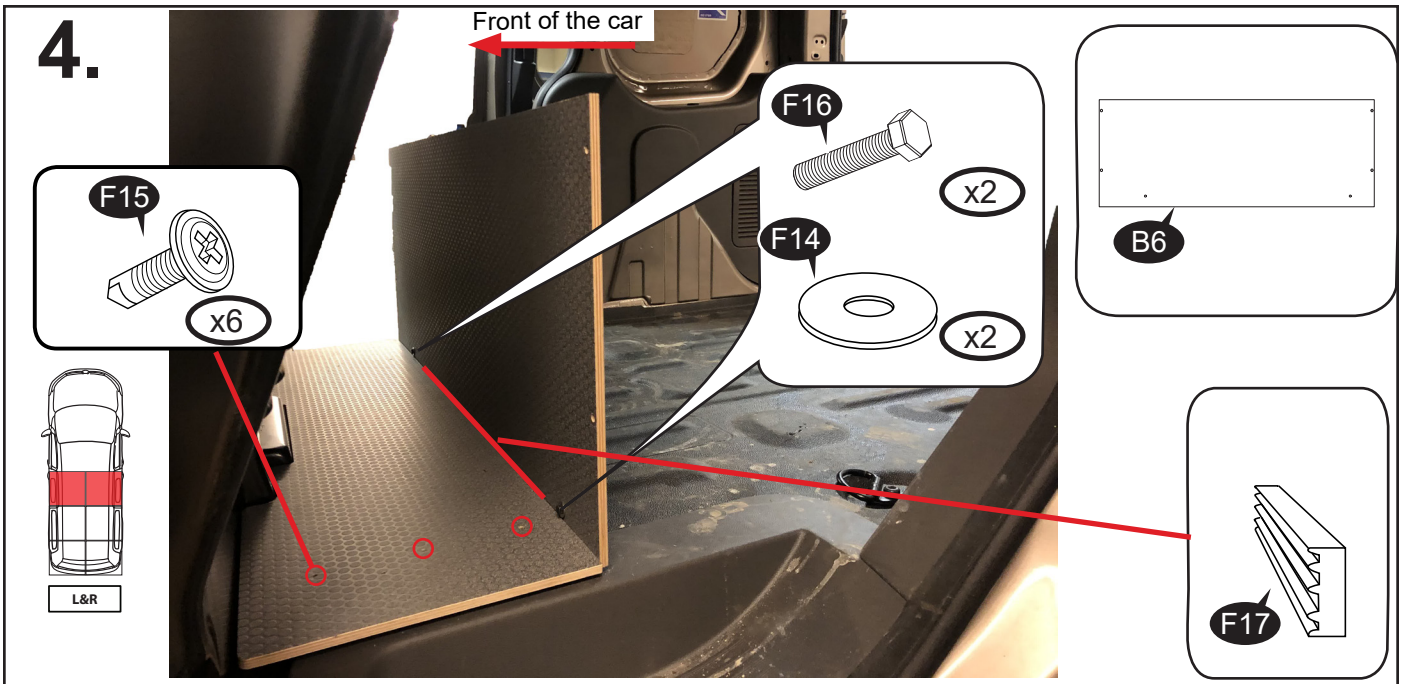

7.

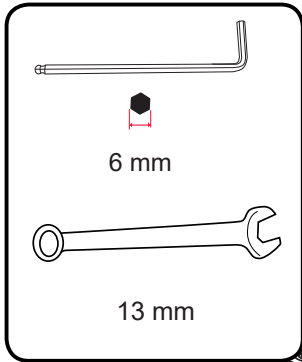

Mount handle on drawer

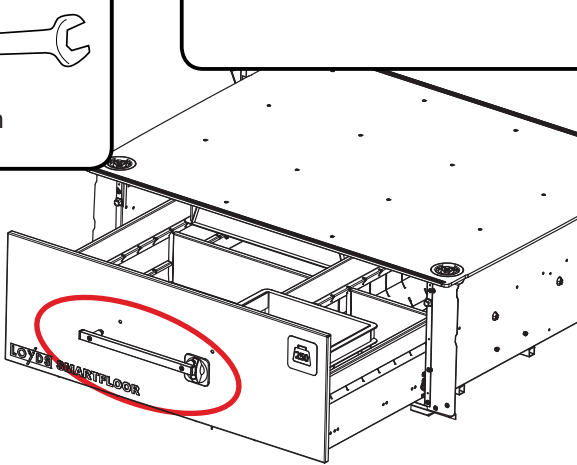
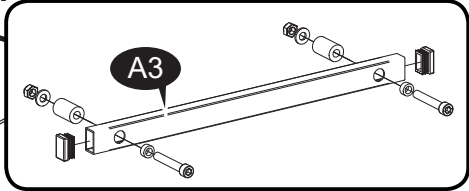

8.

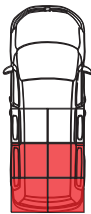
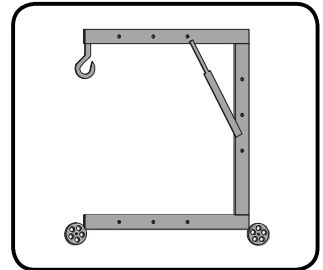

9.

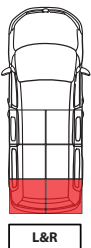
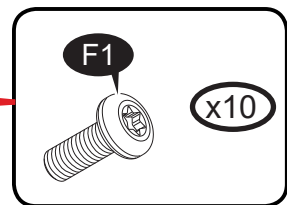
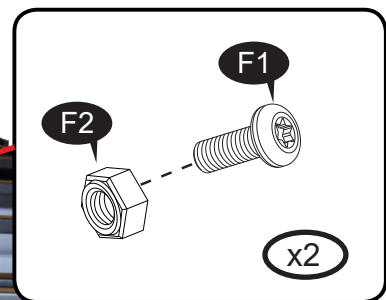
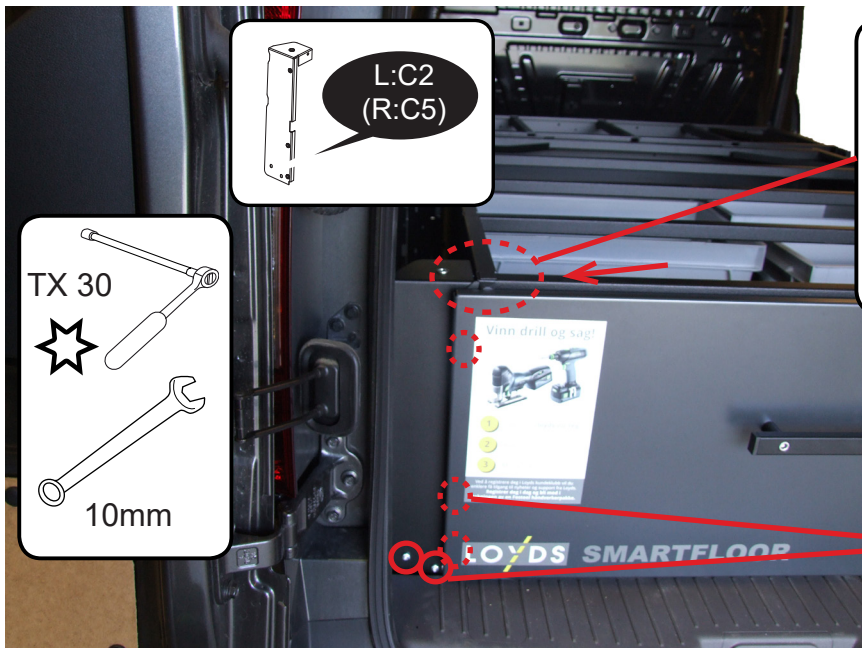

10.

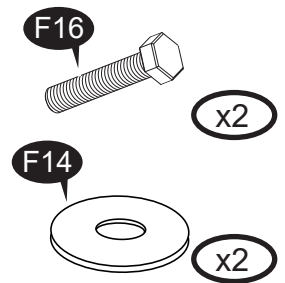
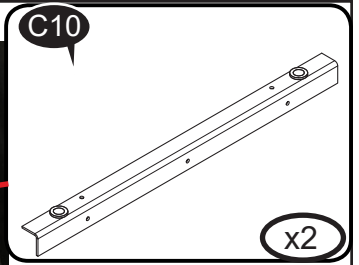
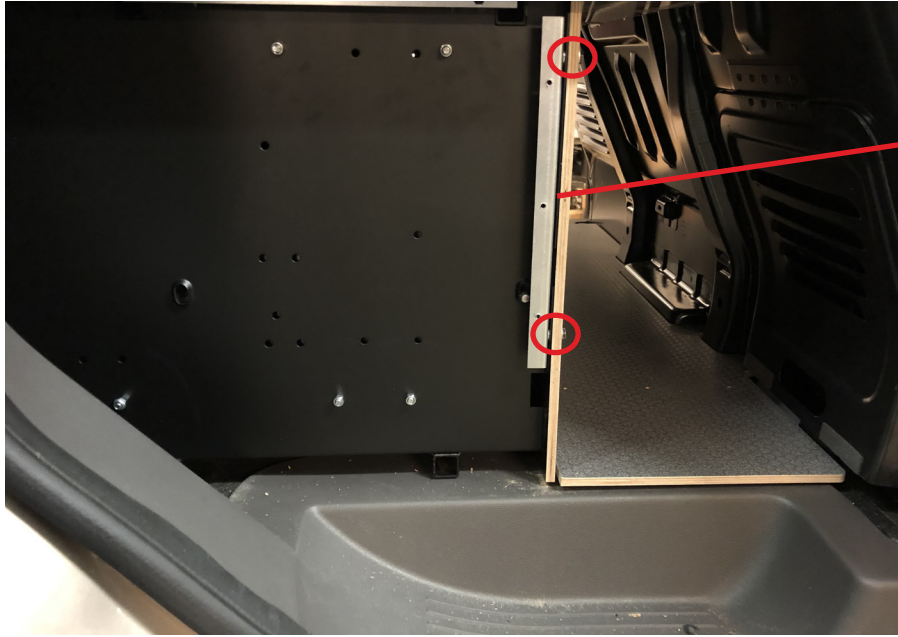
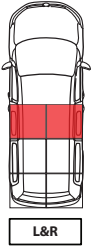

11.

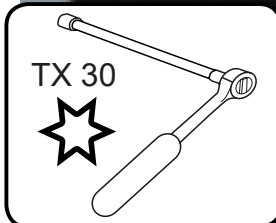
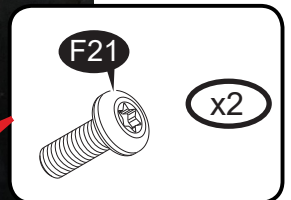
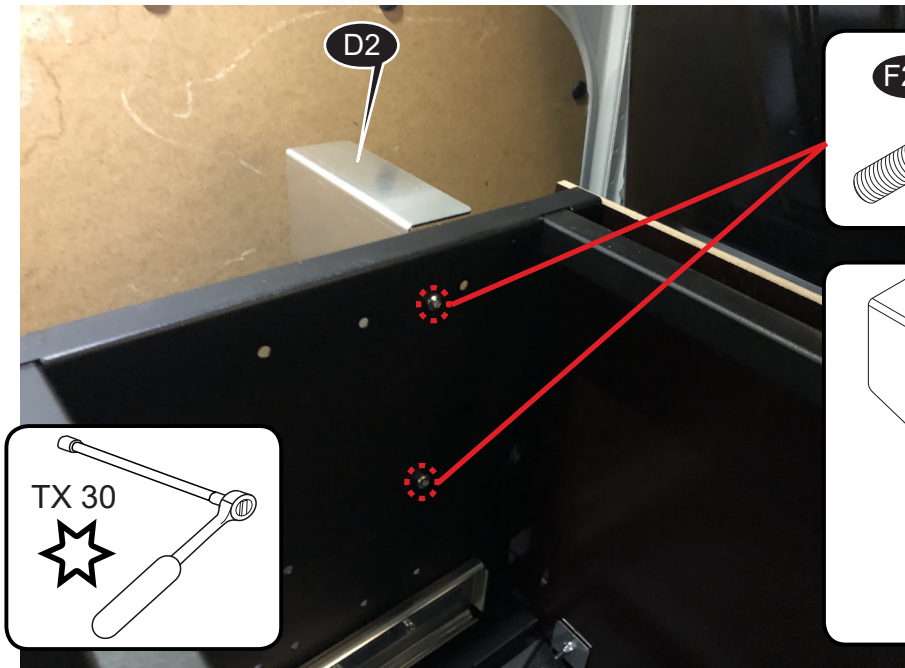
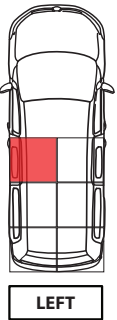

12.

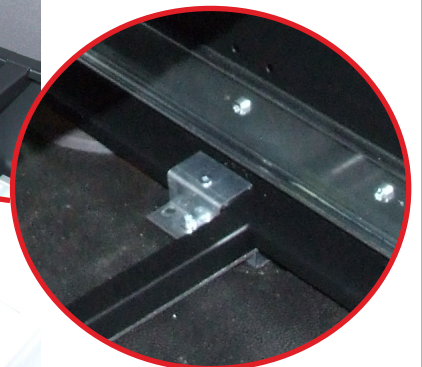
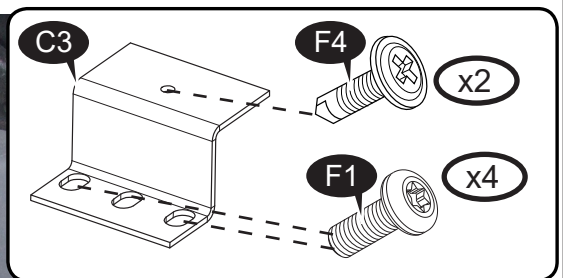
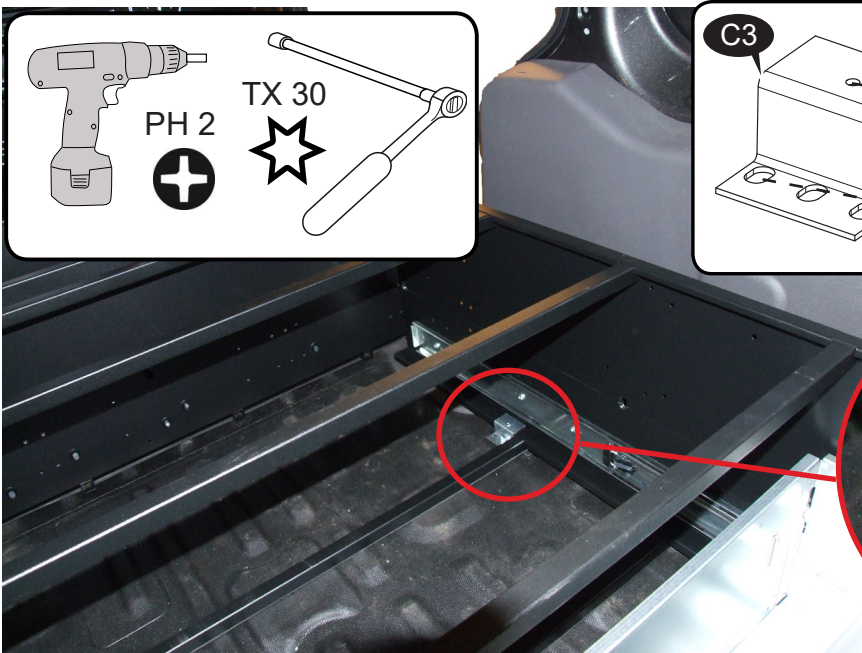
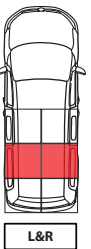
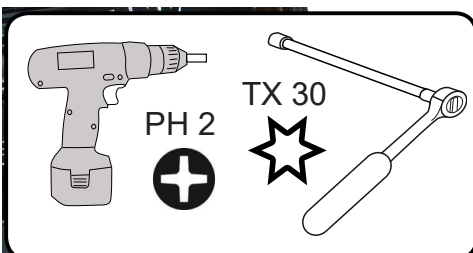

13.

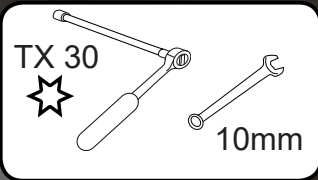
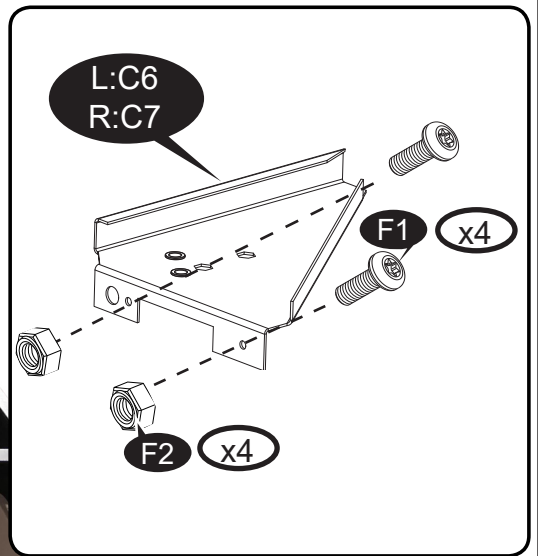
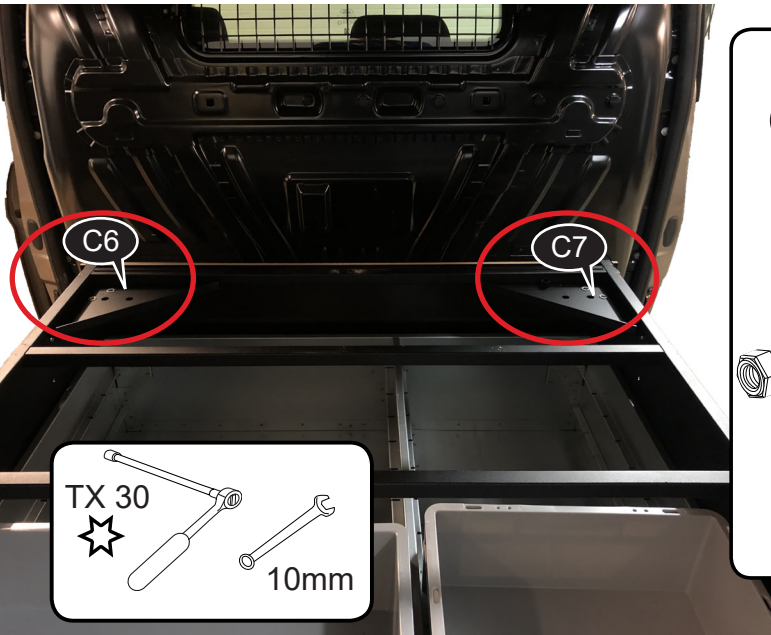
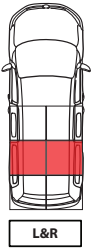

14.

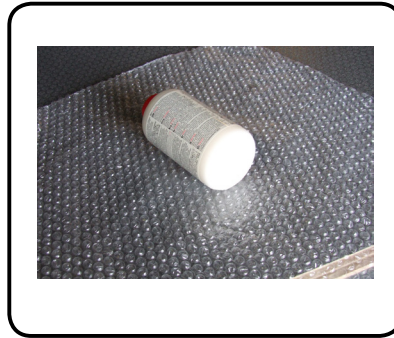
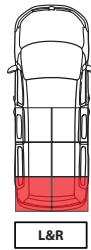

Example of how to protect tire repair kit

15.

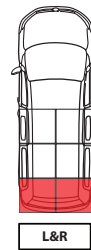

Example of how to protect tire repair kit

Store in drawer

16.

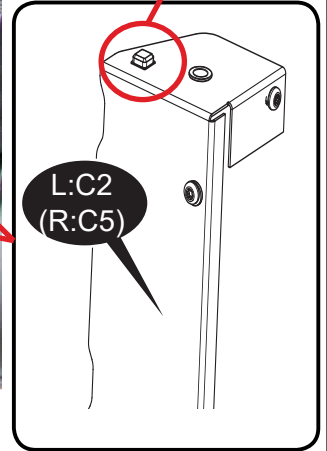
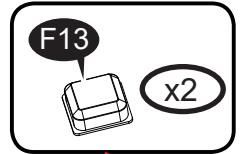
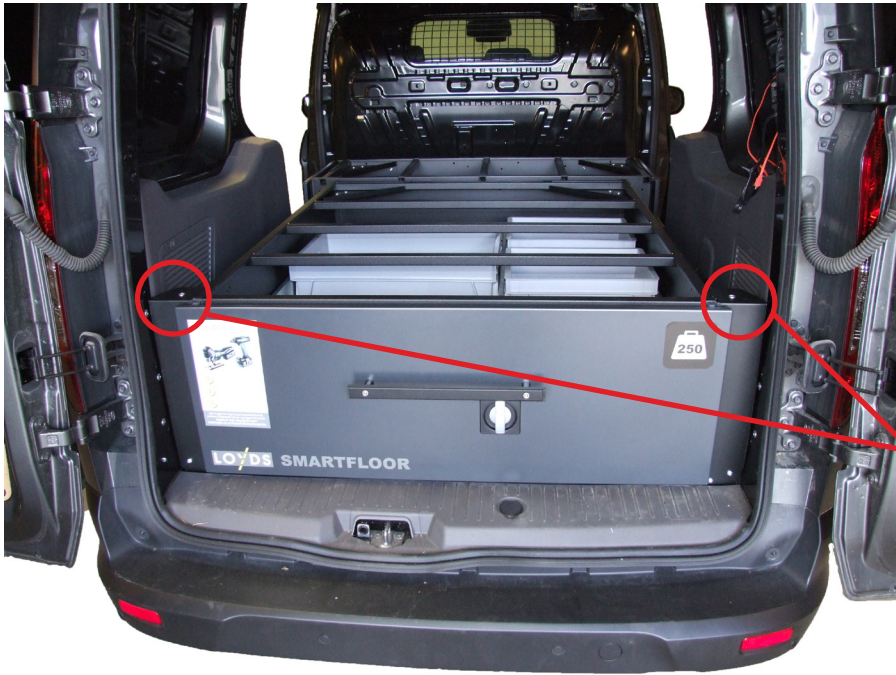
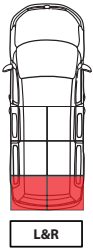

17.

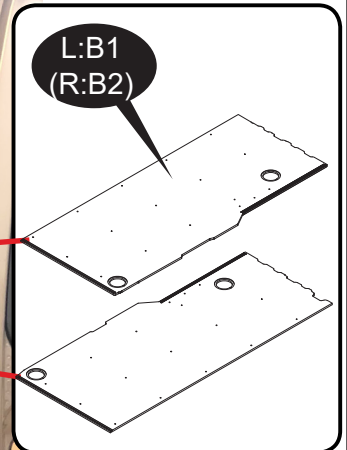
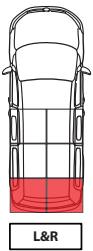

18.

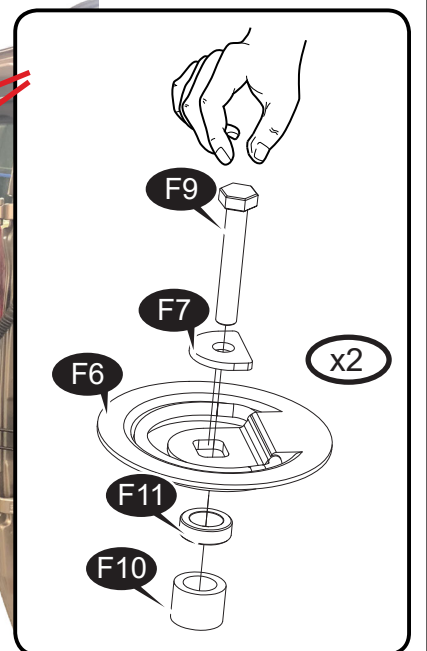
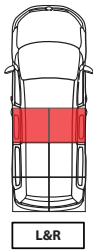

19.



L&R

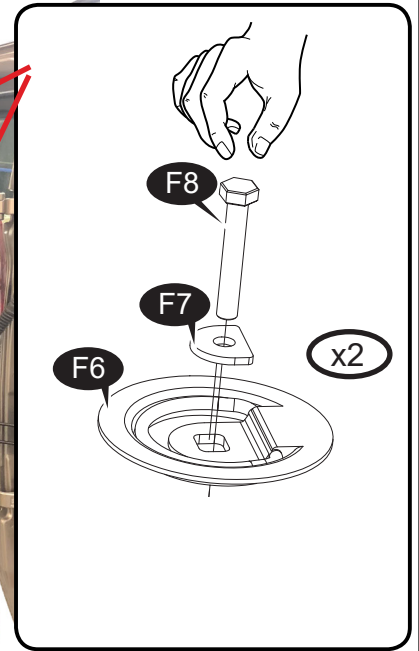

20.

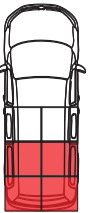

L&R

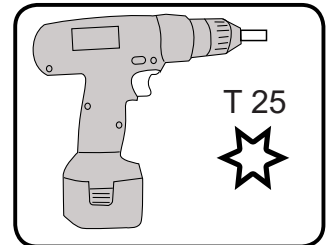
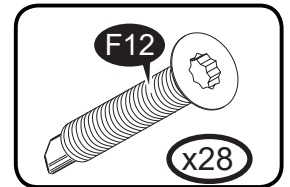

21.



L&R

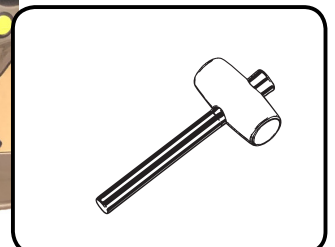
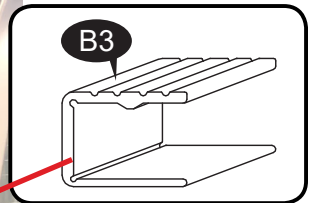

22.

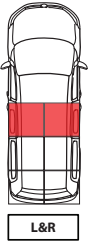

2SLD

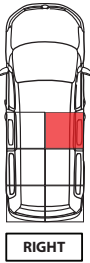

1SLD

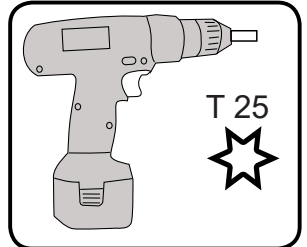
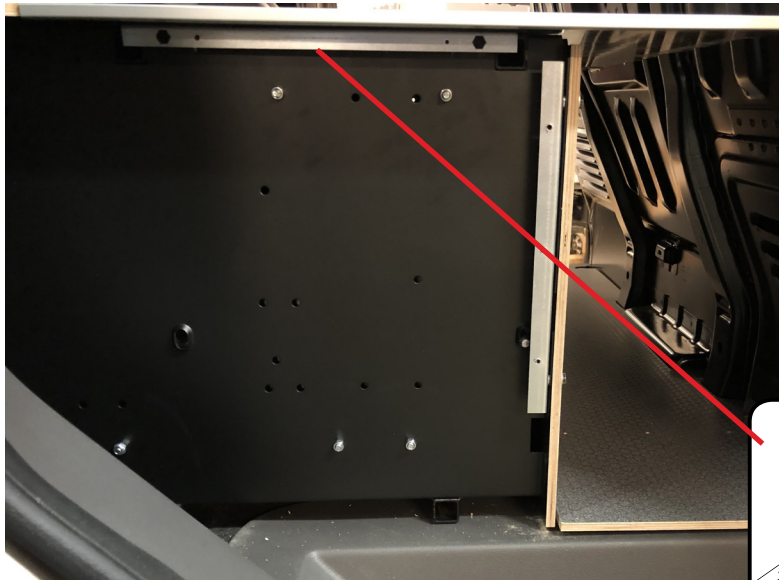

T 25
★

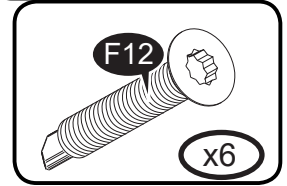

x6

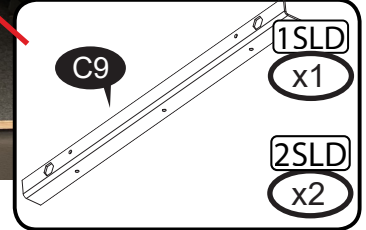

C9

1SLD
x1

2SLD
x2

23.

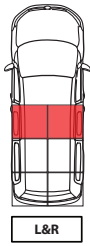

2SLD

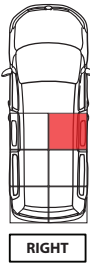

1SLD

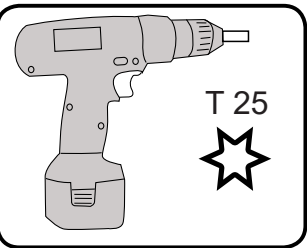
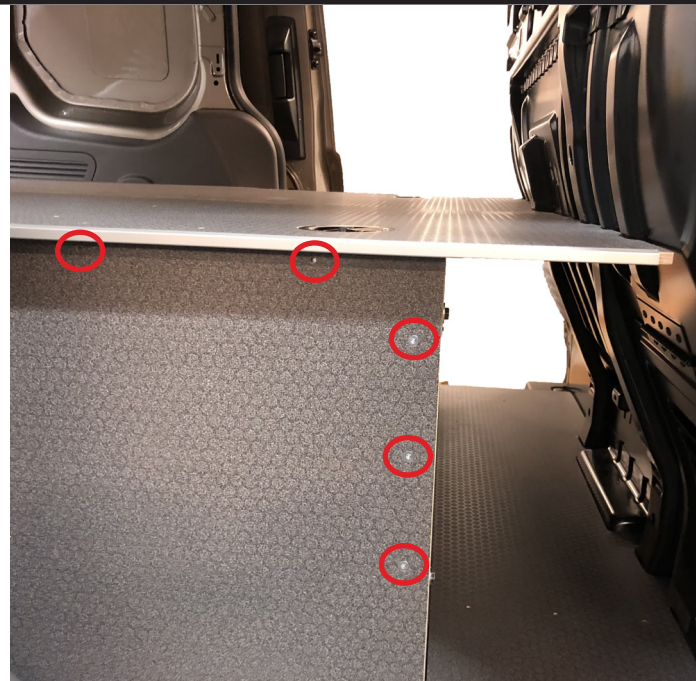

T 25
★

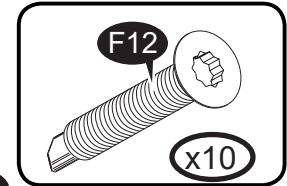

x10

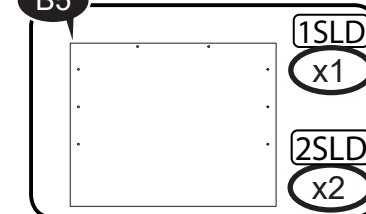

B5

1SLD
x1

2SLD
x2

24.

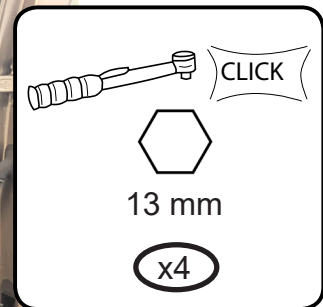

CLICK

13 mm

x4

25.

~~2SLD~~

1SLD

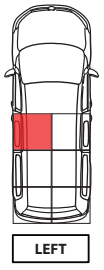

26.

~~2SLD~~

1SLD

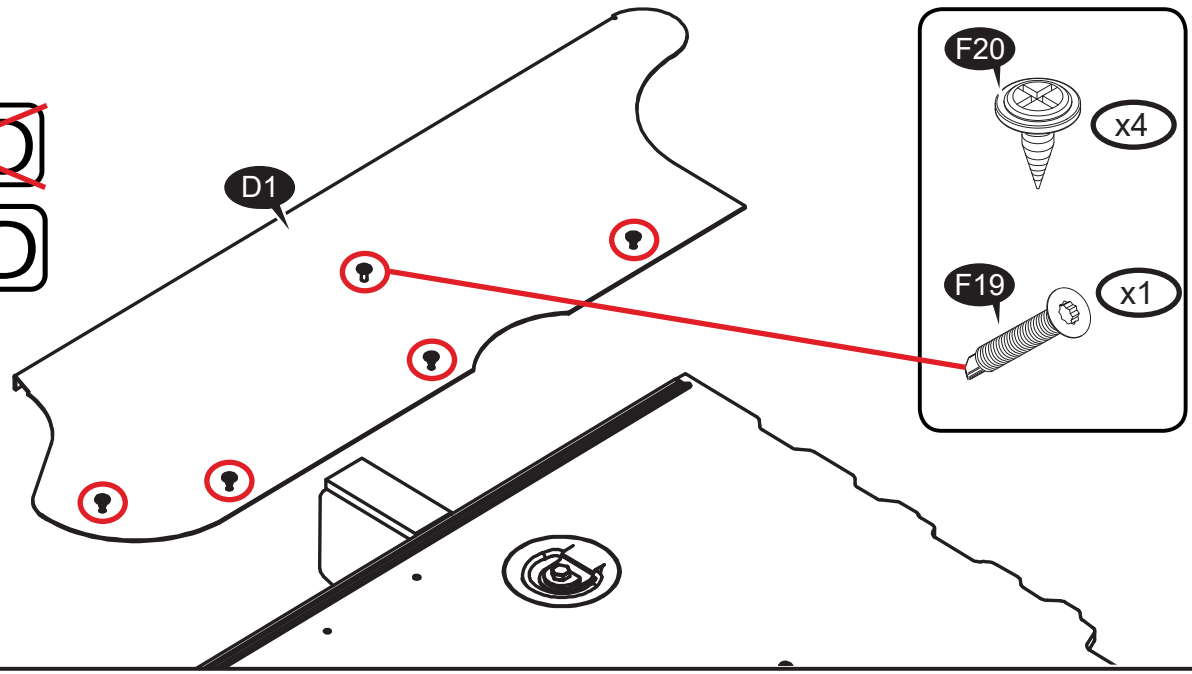
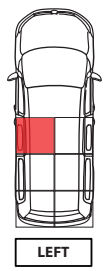

Revision Record

Rev Nr.	Date & Sign	Changes
01	28.11.2019 VFJ	Added a supplement kit for 1SLD

--	--

Date/Author	Date/Constructor
2019-11-15/MDA	2019-11-22/VFJ