

SMARTFLOOR

Ford Transit Custom Installation Manual



Manual nr 15013259 Rev0
Loyds Industri AS 2017-04-18



Revision Record

Rev nr	Date	Page	Picture	Update	New	Deleted steps

Recommended torque for screws:

4,2mm Selfdrilling: 3,6 NM
 6mm: 6 NM
 8mm: 10 NM
 10mm: 42 NM

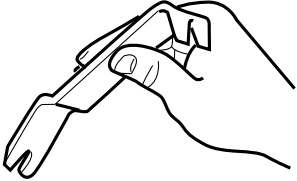
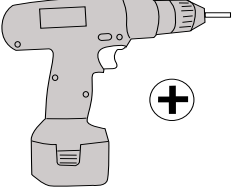
Tools

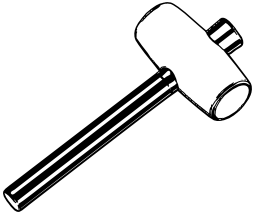
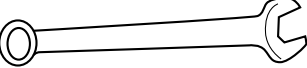
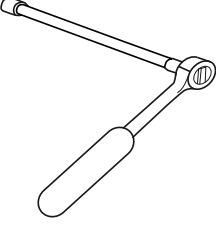
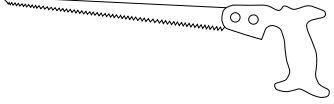
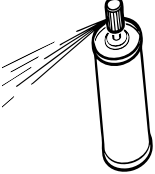
			
10-13 mm 	10-13 mm 	Torx Bits TX 20 TX 25 TX 30	
Lubricant 			

15013300 Kit Complete Ford Custom L1 2SLD

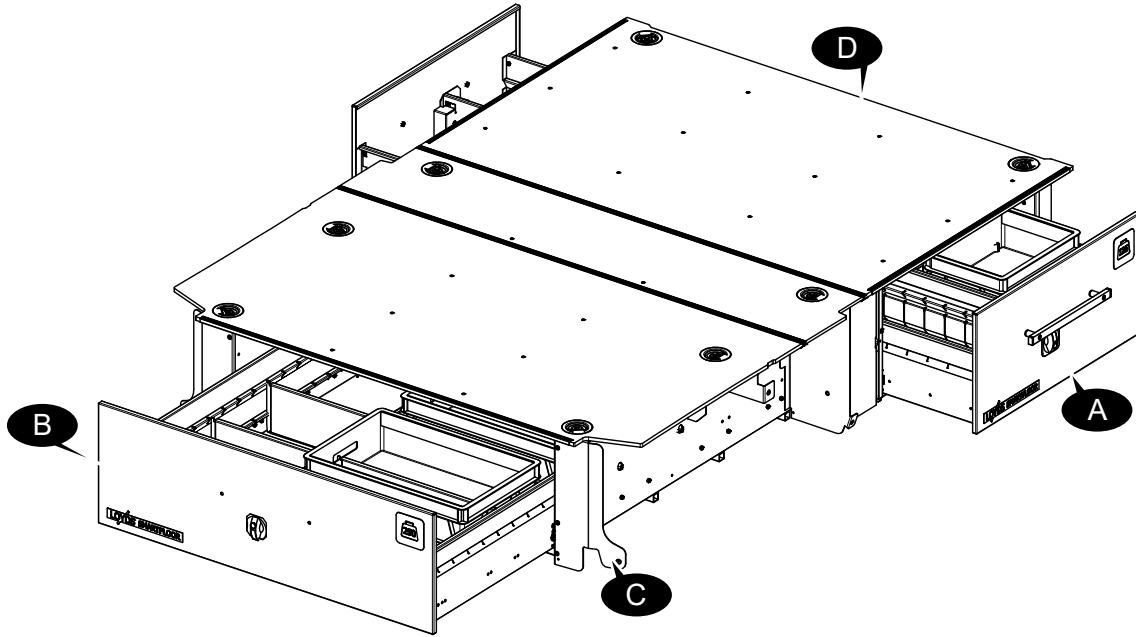

Item	Quantity	Part Number	Description
A	1	15009190	FD2 Front Drawer Complete Assy
B	1	15009300	RD Rear Drawer Complete Assy
C	1	15013303	Steel Bracket Set Ford Custom L1 2SLD
D	1	15013301	Floor Kit Custom L1 2SLD

15013340 Kit Complete Ford Custom L2 2SLD

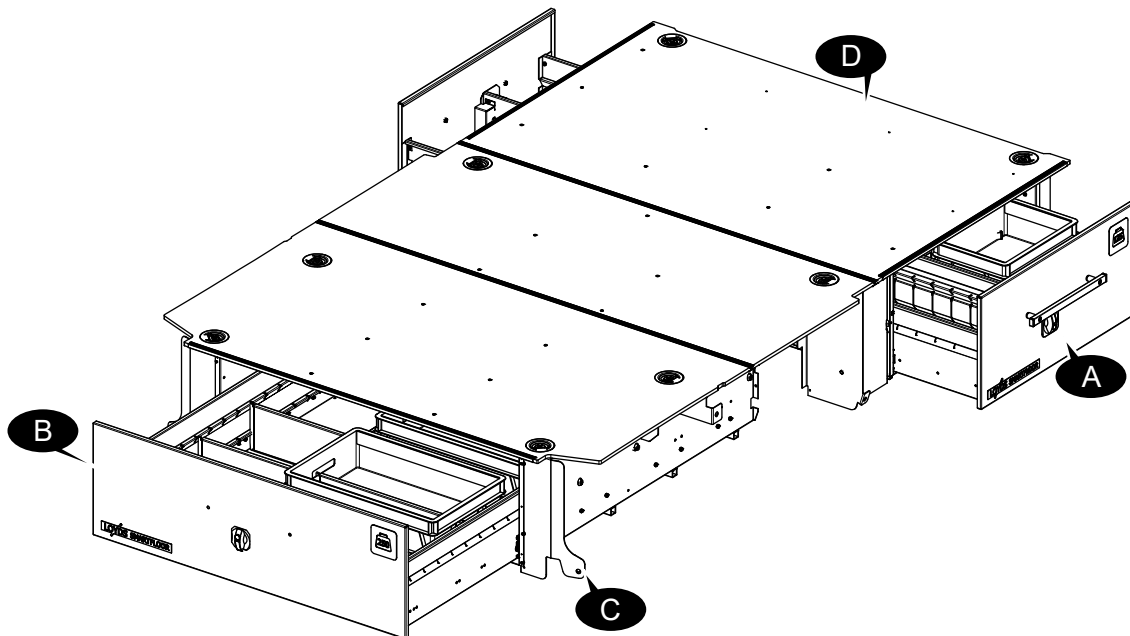

Item	Quantity	Part Number	Description
A	1	15009190	FD2 Front Drawer Complete Assy
B	1	15009300	RD Rear Drawer Complete Assy
C	1	15013338	Steel Bracket Set Ford Custom L2 2SLD
D	1	15013339	Floor Kit Custom L2 2SLD

15010236 Handle Assy

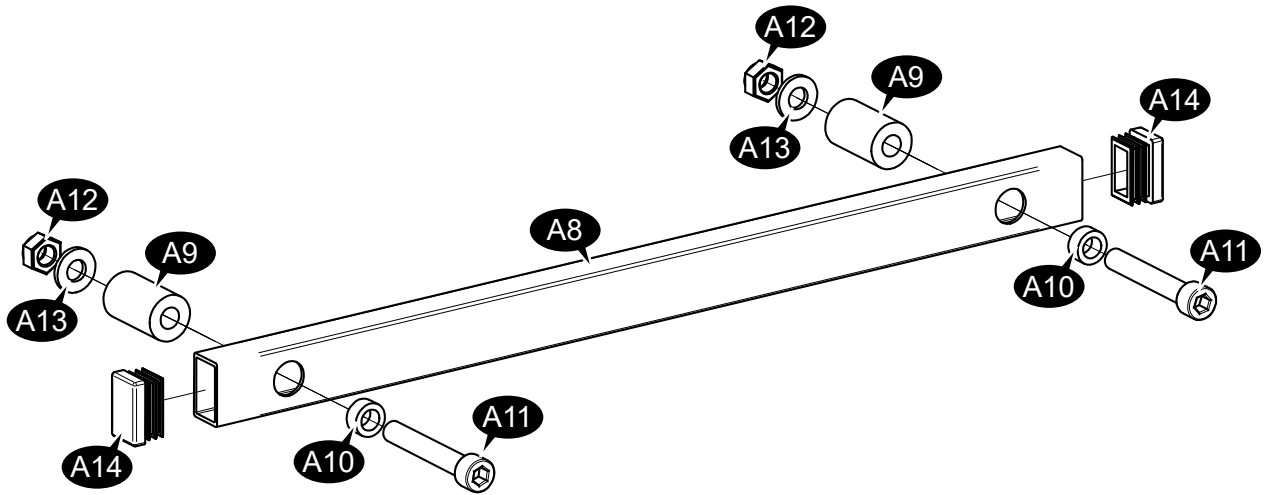

15010236 Handle Assy

Item	Quantity	Part Number	Description
A8	1	15009441	Handle Tube 25x15x286
A9	2	15009442	Spacer Ø8,3x18x30 Nylon Black
A10	2	15009443	Spacer Ø8,1x13x6mm Galv
A11	2	15009444	Screw M8x50 Cylinderh Hex
A12	2	8 NMU	Mutter M8 Nyloc DIN985
A13	2	8,4x17x2	M8 Washer, DIN 125
A14	2	15009438	End Plug Tube 25x15 Inside

15013301 Floor Kit Custom L1 2SLD

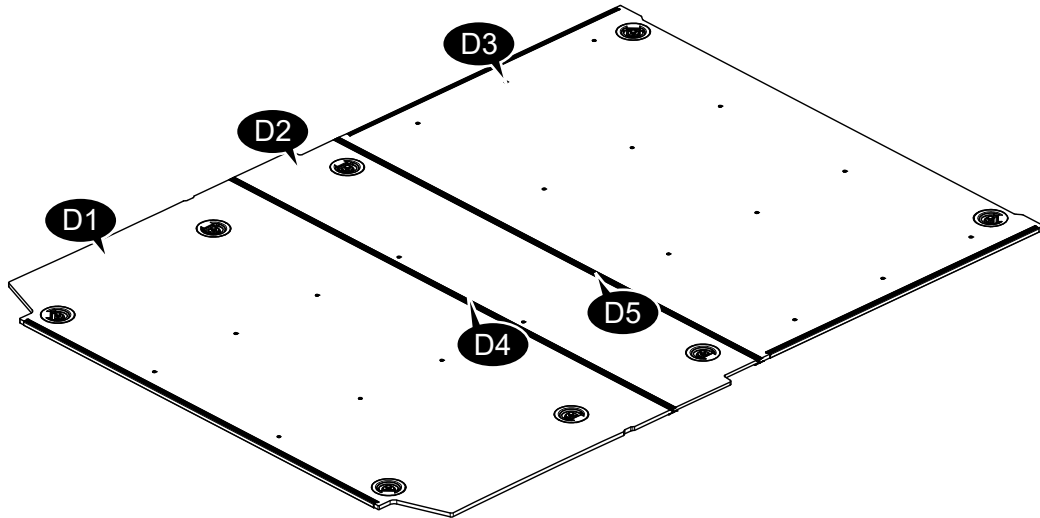

Item	Quantity	Part Number	Description
D1	1	15013330	Rear Floor Custom L1 ASSY
D2	1	15013318	Middle Floor Custom L1
D3	1	15013331	Front Floor Custom ASSY
D4	1	15013322	H-profile 12mm L=1714
D5	1	15013321	H-profile 12mm L=1643

15013339_A Floor Kit Custom L2 2SLD

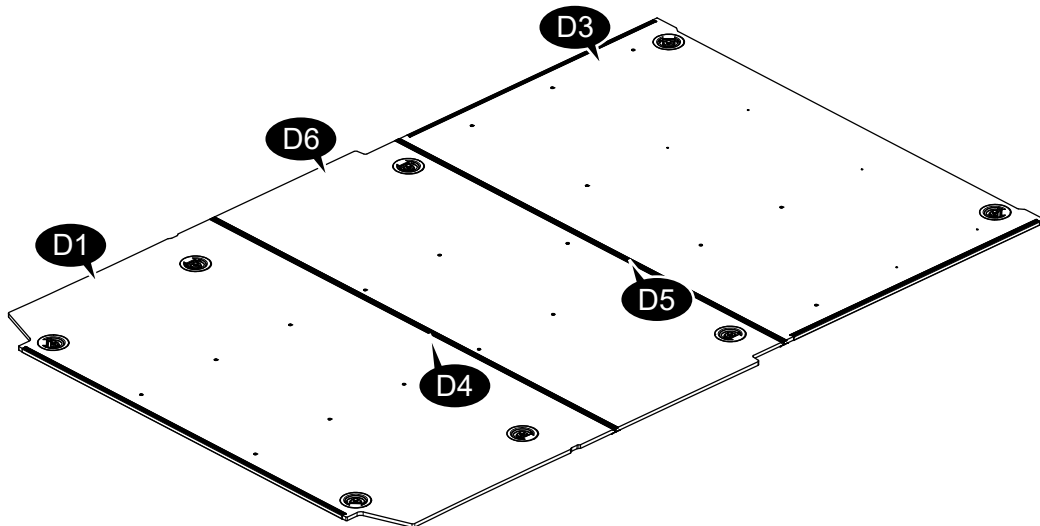

Item	Quantity	Part Number	Description
D1	1	15013330	Rear Floor Custom L1 ASSY
D3	1	15013331	Front Floor Custom ASSY
D4	1	15013322	H-profile 12mm L=1714
D5	1	15013321	H-profile 12mm L=1643
D6	1	15013337	Middle Floor Custom L2

15013303 Steel Bracket Set Ford Custom L1 2SLD

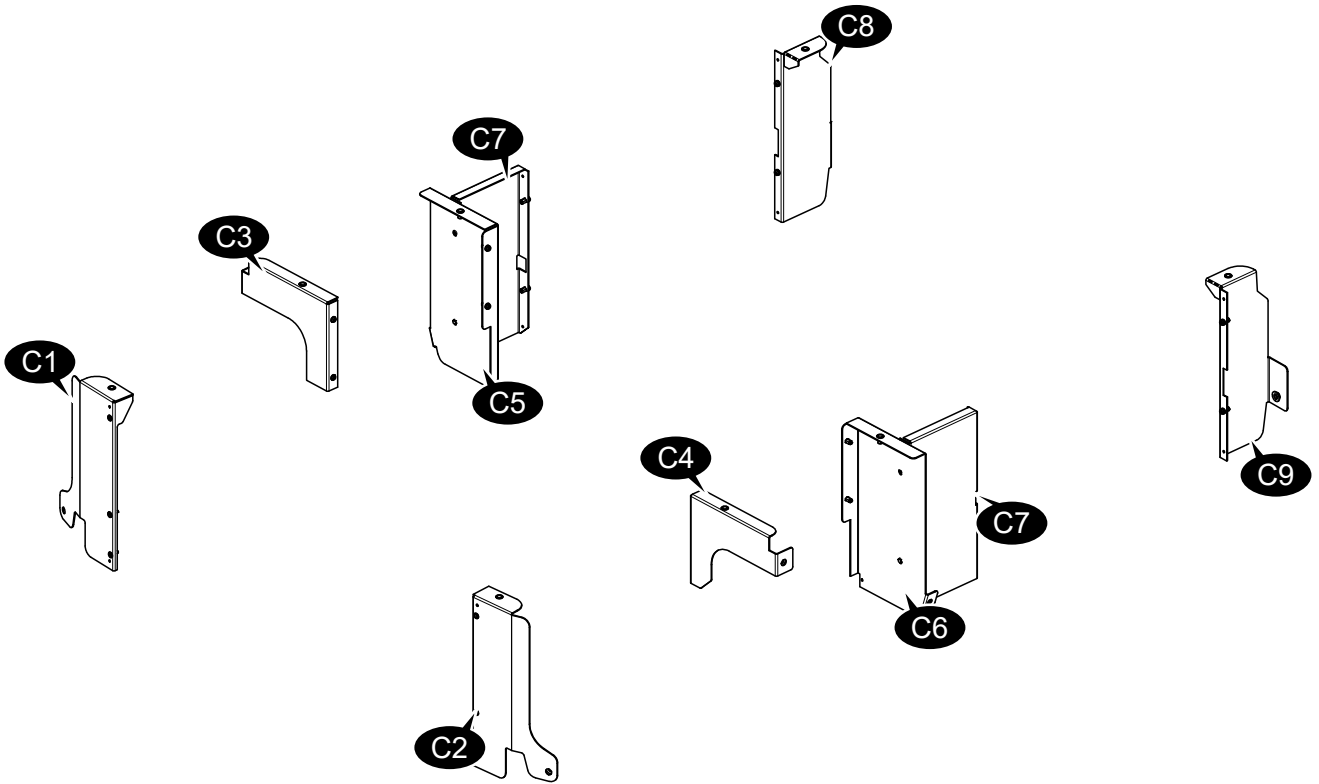

Item	Quantity	Part Number	Description
C1	1	15013314	Bracket Rear Left Custom ASSY
C2	1	15013316	Bracket Rear Right Custom ASSY
C3	1	15013326	Bracket Side Fix Rear Left Custom ASSY
C4	1	15013328	Bracket Side Fix Rear Right Custom ASSY
C5	1	15013310	Bracket Middle Left Custom ASSY
C6	1	15013312	Bracket Middle Right Custom ASSY
C7	2	15013324	Bracket Fix FD RD Custom ASSY
C8	1	15013306	Bracket Front Left Custom ASSY
C9	1	15013308	Bracket Front Right Custom ASSY

15013338 Steel Bracket Set Ford Custom L2 2SLD

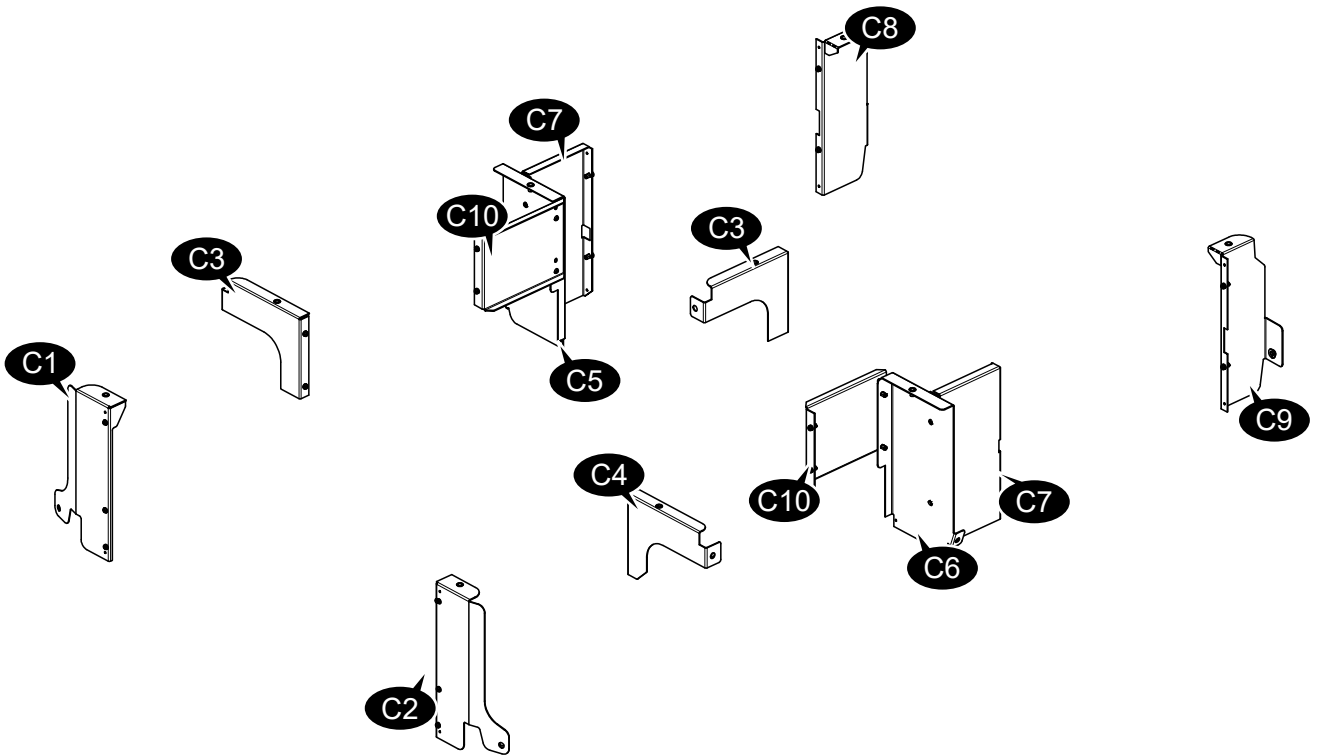

Item	Quantity	Part Number	Description
C1	1	15013314	Bracket Rear Left Custom ASSY
C2	1	15013316	Bracket Rear Right Custom ASSY
C3	2	15013326	Bracket Side Fix Rear Left Custom ASSY
C4	1	15013328	Bracket Side Fix Rear Right Custom ASSY
C5	1	15013310	Bracket Middle Left Custom ASSY
C6	1	15013312	Bracket Middle Right Custom ASSY
C7	2	15013324	Bracket Fix FD RD Custom ASSY
C8	1	15013306	Bracket Front Left Custom ASSY
C9	1	15013308	Bracket Front Right Custom ASSY
C10	2	15013336	Bracket L2 Fix Custom ASSY

Fitting Kit

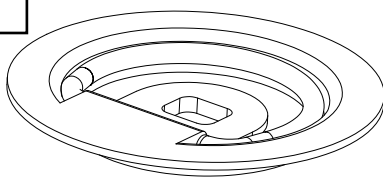
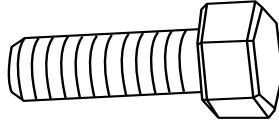
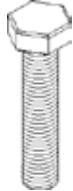
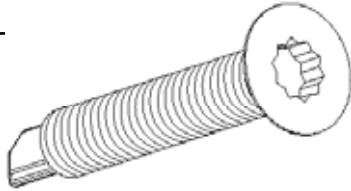
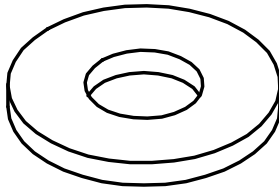
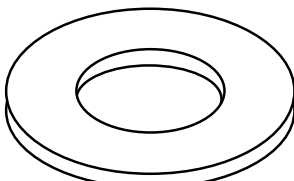
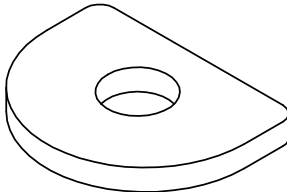
<p>F1</p>  <p style="text-align: center;">15003551 M6x16 TX30 pan (DIN 7985)</p>	<p>F2</p>  <p style="text-align: center;">15005497 Latch Cup Black Ø90 Ø12x15 1000Kp</p>	<p>F3</p>  <p style="text-align: center;">6x16 6k M6 Bolt, DIN 933</p>
<p>F4</p>  <p style="text-align: center;">8x40 M8x40mm Bolt, DIN 933, sort</p>	<p>F5</p>  <p style="text-align: center;">15009568 Screw 4,8x32 Selfdrill Counters Torx Elz</p>	<p>F6</p>  <p style="text-align: center;">15009916 Washer 30x13x3 Elz</p>
<p>F7</p>  <p style="text-align: center;">7-16x1mm Washer Washer 7/16"x1mm elzn</p>	<p>F8</p>  <p style="text-align: center;">15005884 Washer Latchcup for Ø8</p>	<p>F9</p>
<p>F10</p>	<p>F11</p>	<p>F12</p>
<p>F13</p>	<p>F14</p>	<p>F15</p>
<p>F16</p>	<p>F17</p>	<p>F18</p>
<p>F19</p>	<p>F20</p>	<p>F21</p>

1.

L&R



(x8)



(x8)



2.

L&R

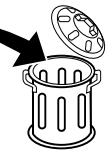

3.

Back door

L&R

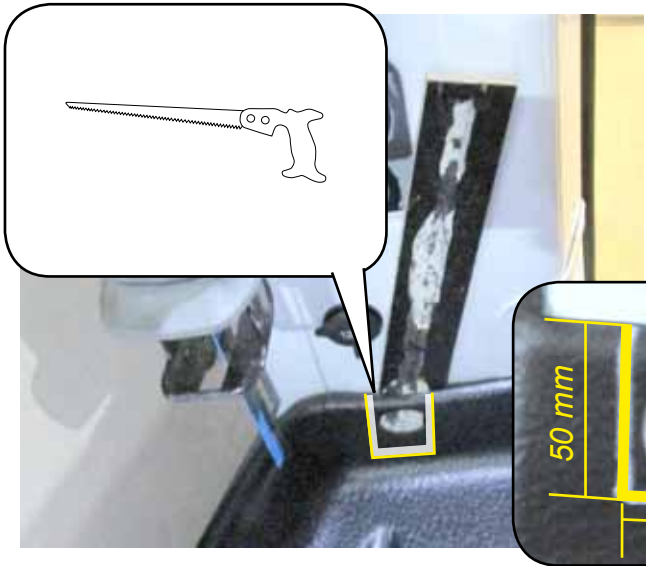

4.

Slide door

L&R

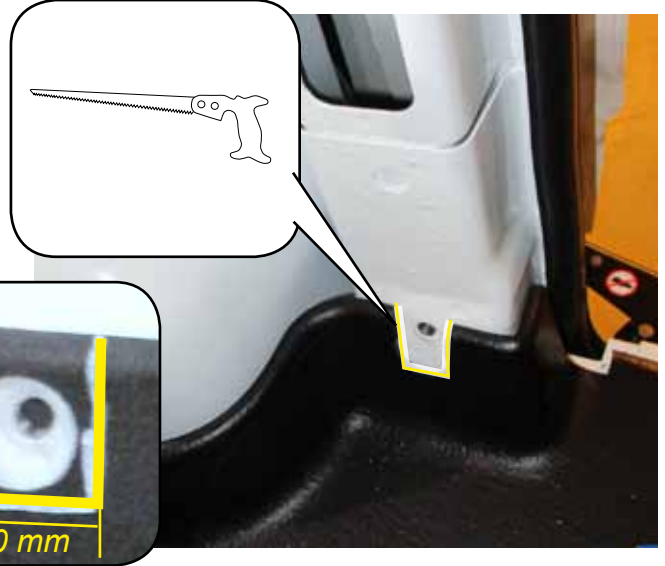

5.

Front drawer

6.

Rear drawer

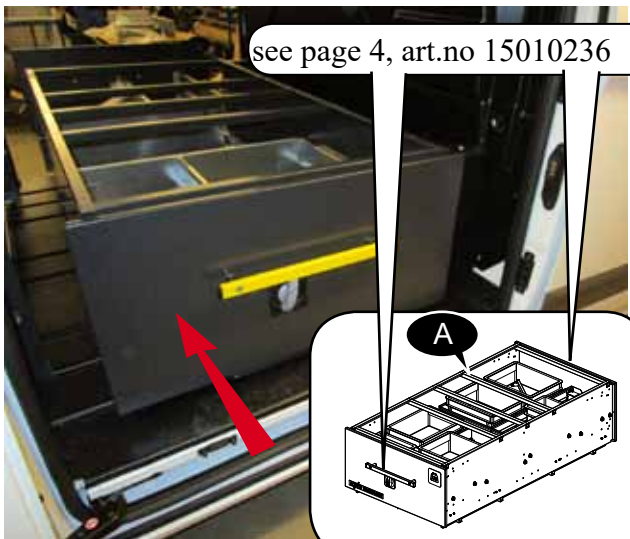

see page 4, art.no 15010236

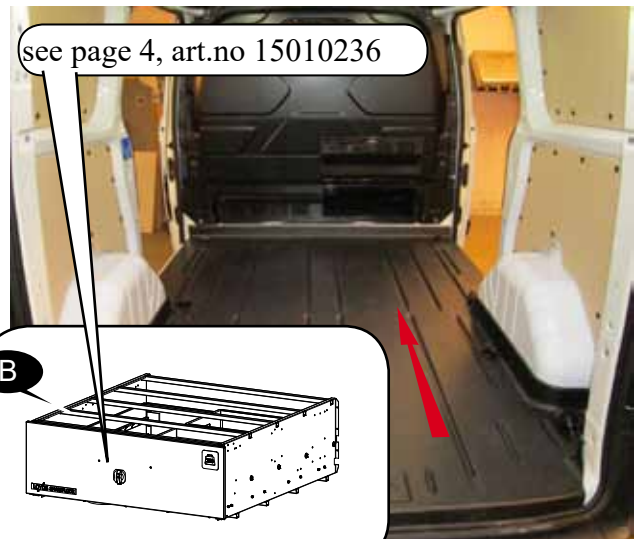

see page 4, art.no 15010236

7.

L&R



Lubricant



Apply to:
All bolts & holes



8.

L&R

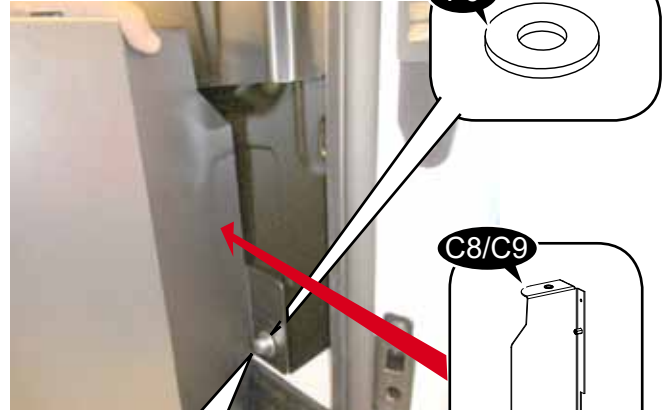

F6

C8/C9

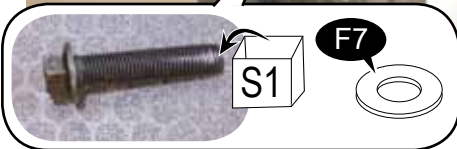

S1

F7

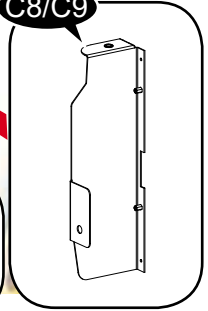

9.

L&R

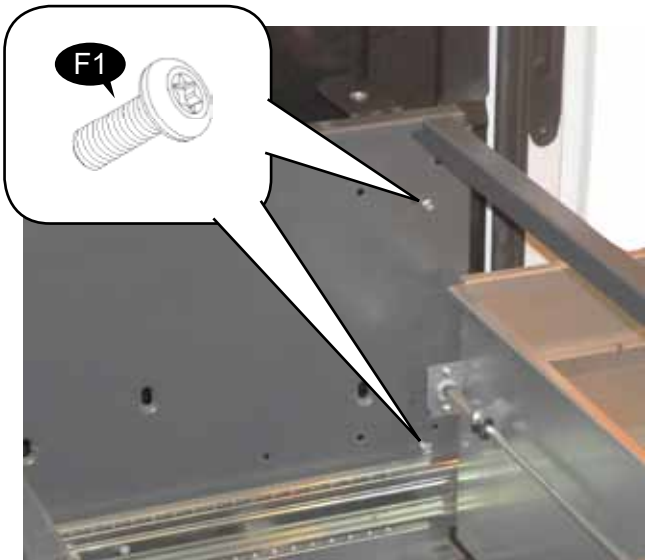

F1

10.

Slide door

L&R

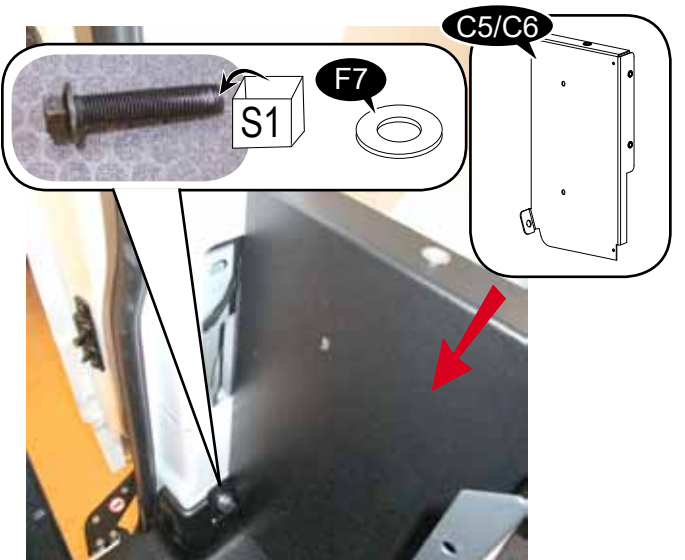

S1

F7

C5/C6

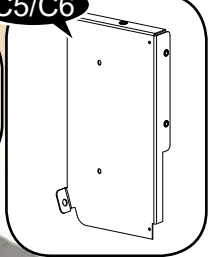

11.

L1 2SLD

L&R

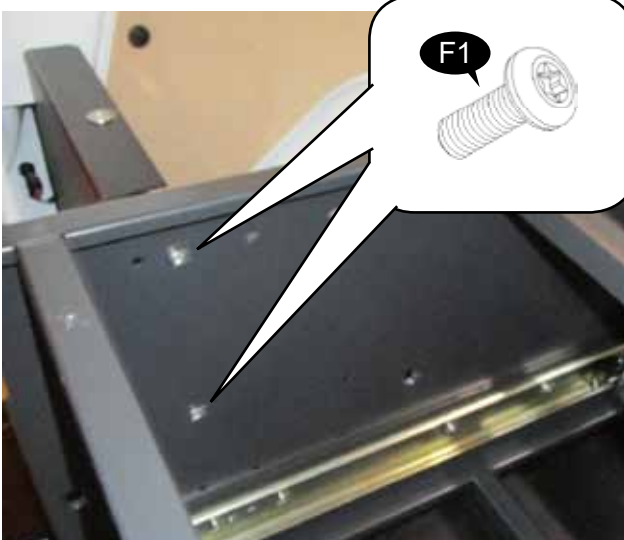

F1

12.

L2 2SLD

L&R

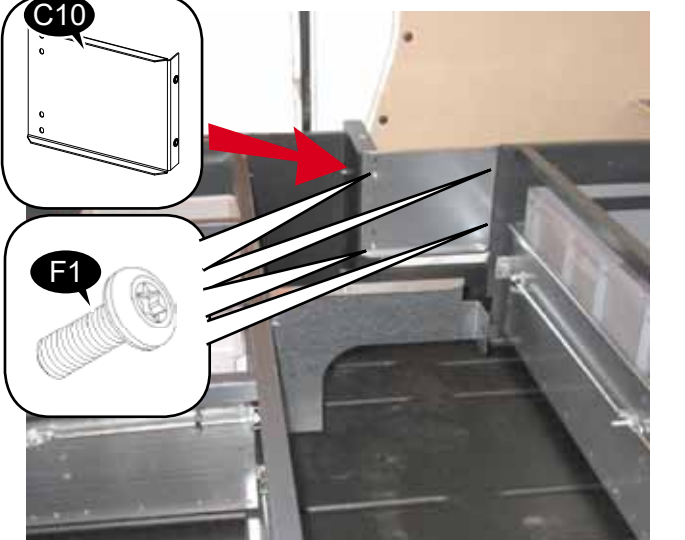

F1

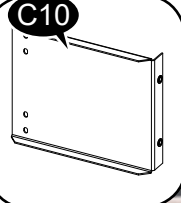

C10

13.

L&R



14.

L&R

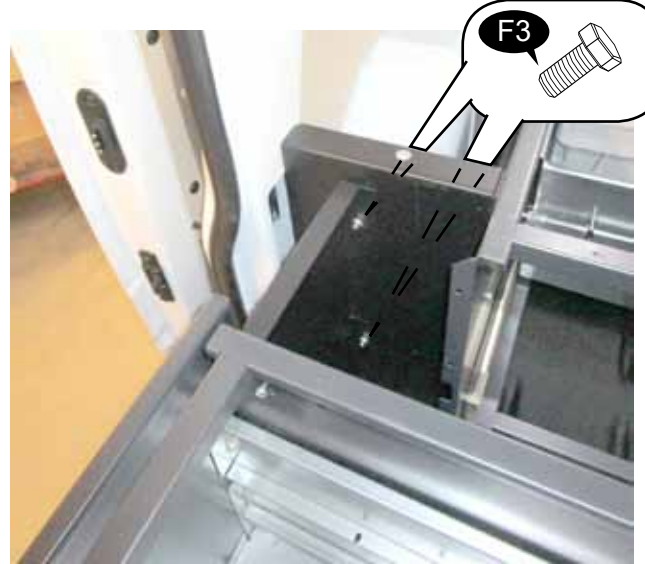

15.

L&R

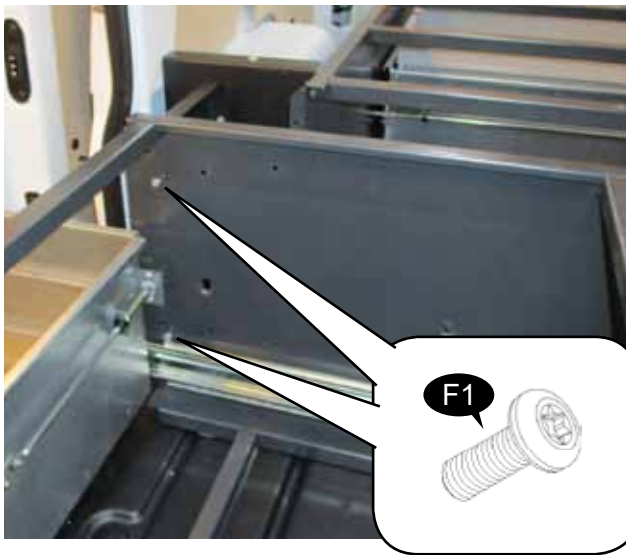

16.

L&R

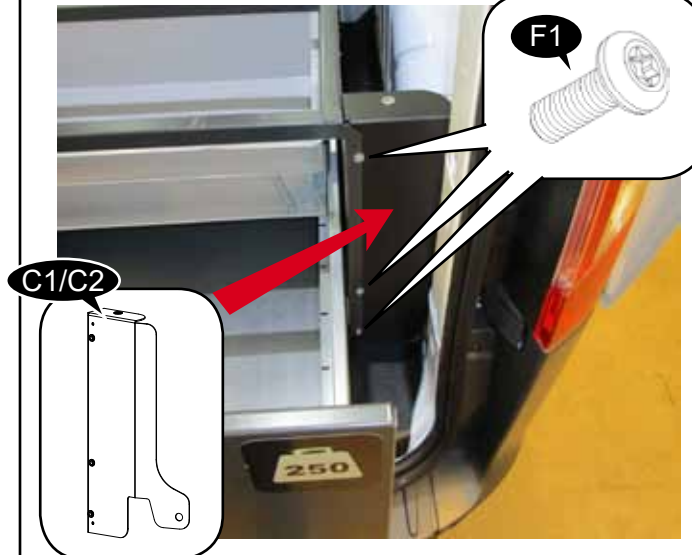

17.

L&R

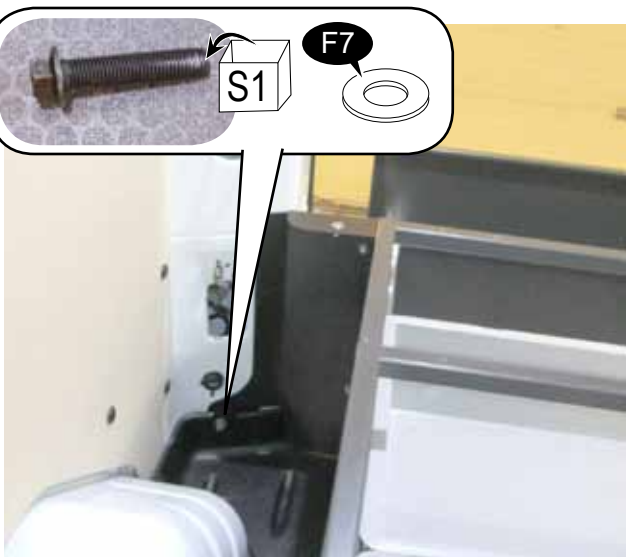

18.

L&R

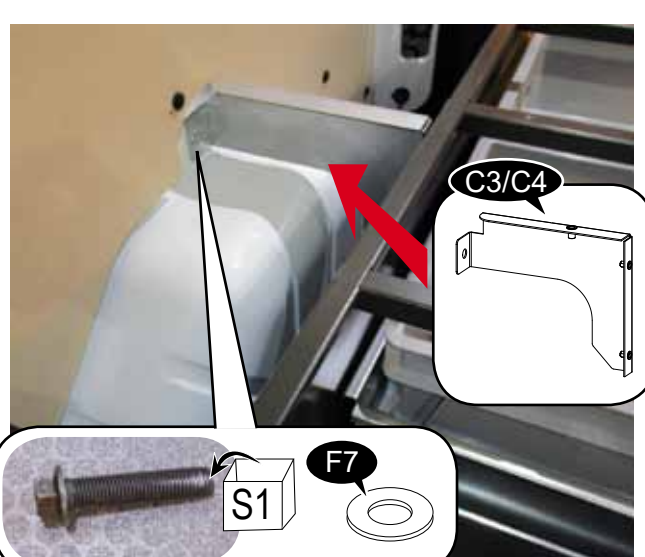

19.

L&R



20.

L2 2SLD

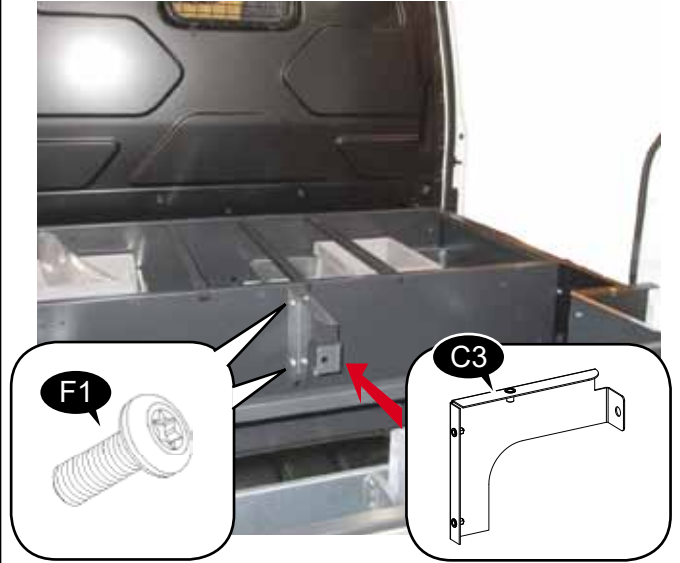

21.

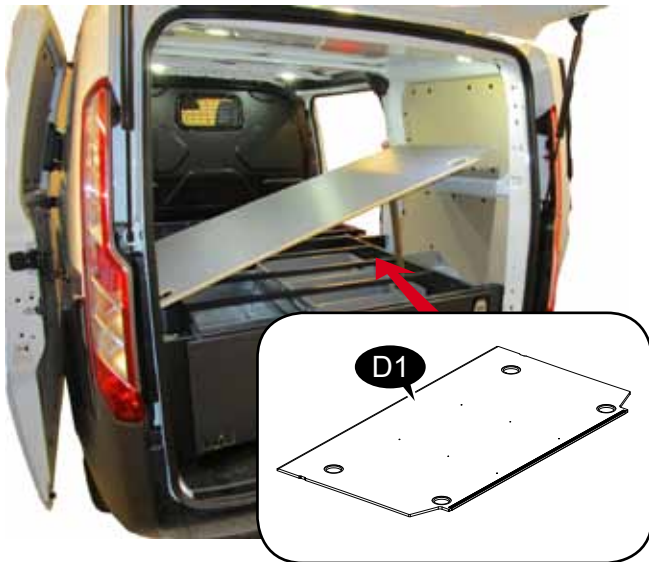

22.

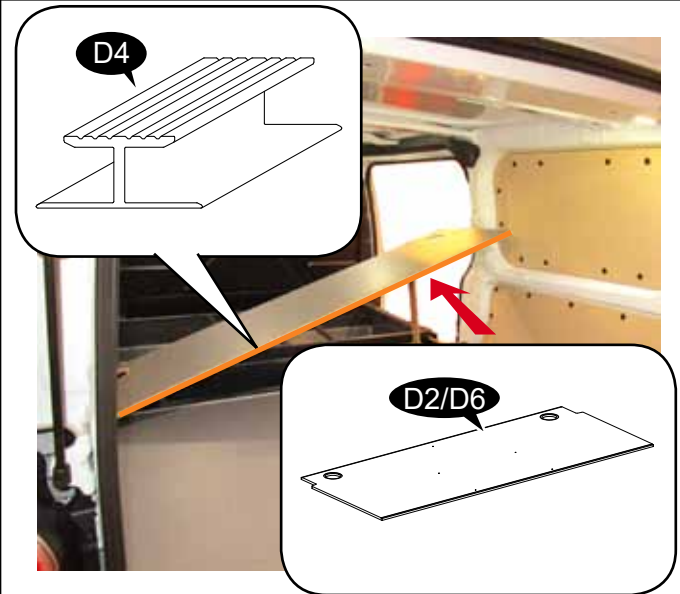

23.

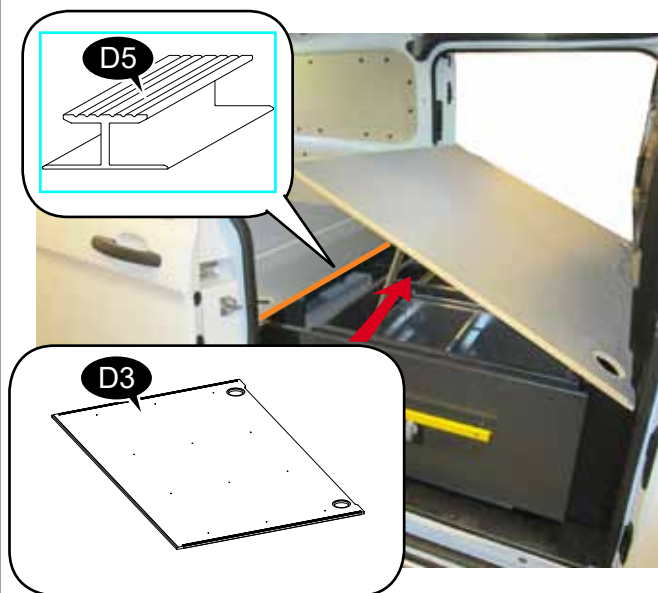

24.

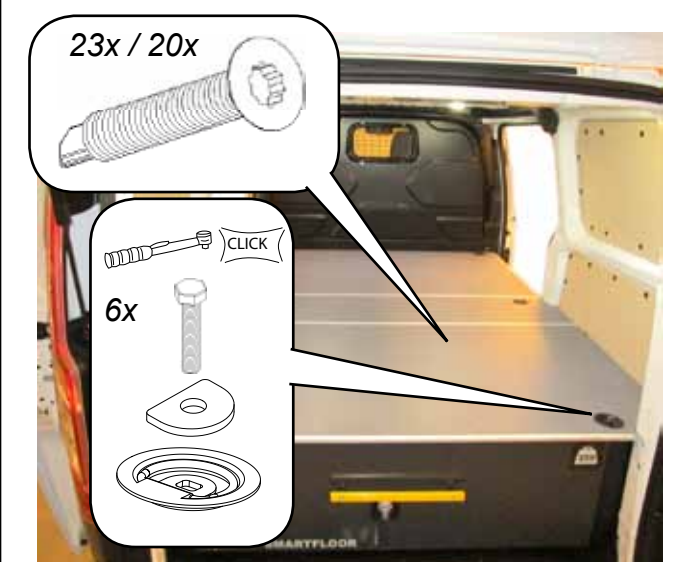

25.	26.
27.	28.
29.	30.

31.	32.
33.	34.
35.	36.

37.	38.
39.	40.
41.	42.

43.	44.
45.	46.
47.	48.