

# SMARTFLOOR

## Ford Transit Custom

15013300 Kit Complete Ford Custom L1 2SLD

15013340 Kit Complete Ford Custom L2 2SLD

15015200 Kit Complete Ford Custom L1 1SLD

15015201 Kit Complete Ford Custom L2 1SLD

## Installation Manual



Manual nr 15013259 Rev1  
Loyds Industri AS 2018-09-19



# Revision Record

Rev nr	Date	Page	Picture	Update	New	Deleted steps
1	19.09.2018			Added 1SLD versions		

## Recommended torque for screws:

4,2mm Selfdrilling: 3,6 NM  
 6mm: 6 NM  
 8mm: 10 NM  
 10mm: 42 NM

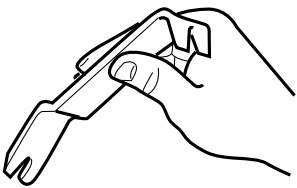
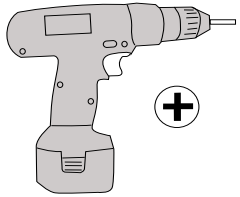
# Tools

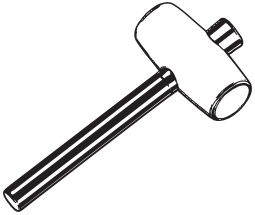
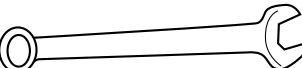
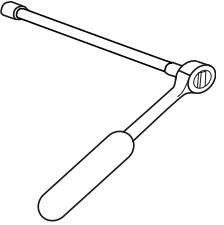
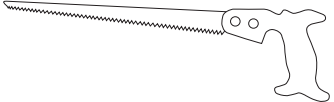
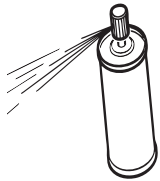
			
10-13 mm 	10-13 mm 	Torx Bits TX 20 TX 25 TX 30	
Lubricant 			

## 15013300 Kit Complete Ford Custom L1 2SLD

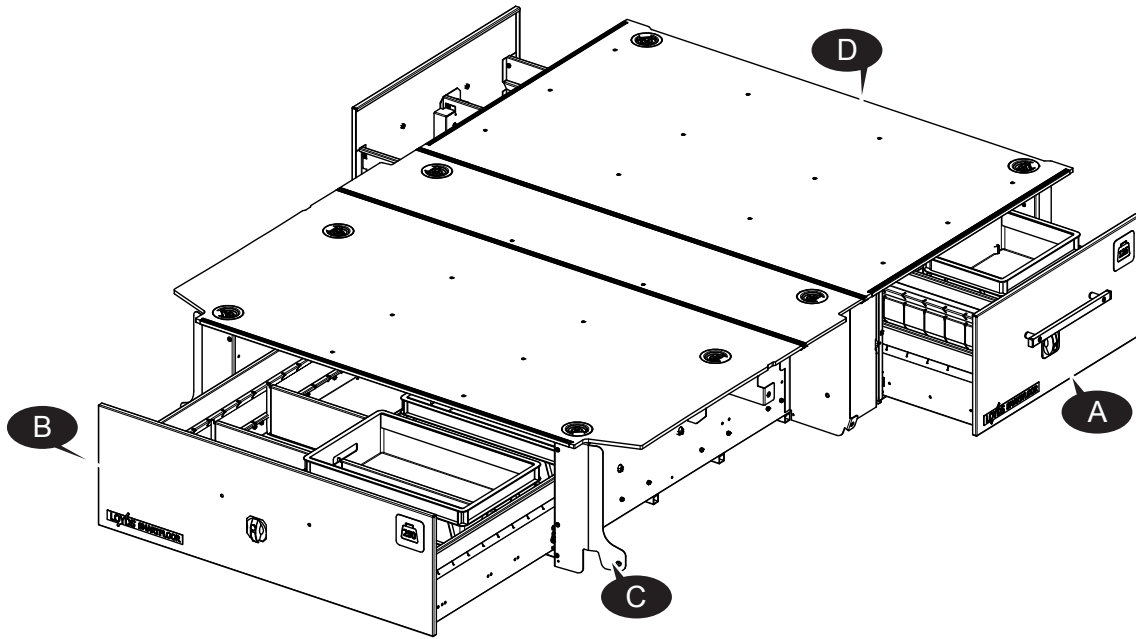

Item	Quantity	Part Number	Description
A	1	15009190	FD2 Front Drawer Complete Assy
B	1	15009300	RD Rear Drawer Complete Assy
C	1	15013303	Steel Bracket Set Ford Custom L1 2SLD
D	1	15013301	Floor Kit Custom L1 2SLD

## 15013340 Kit Complete Ford Custom L2 2SLD

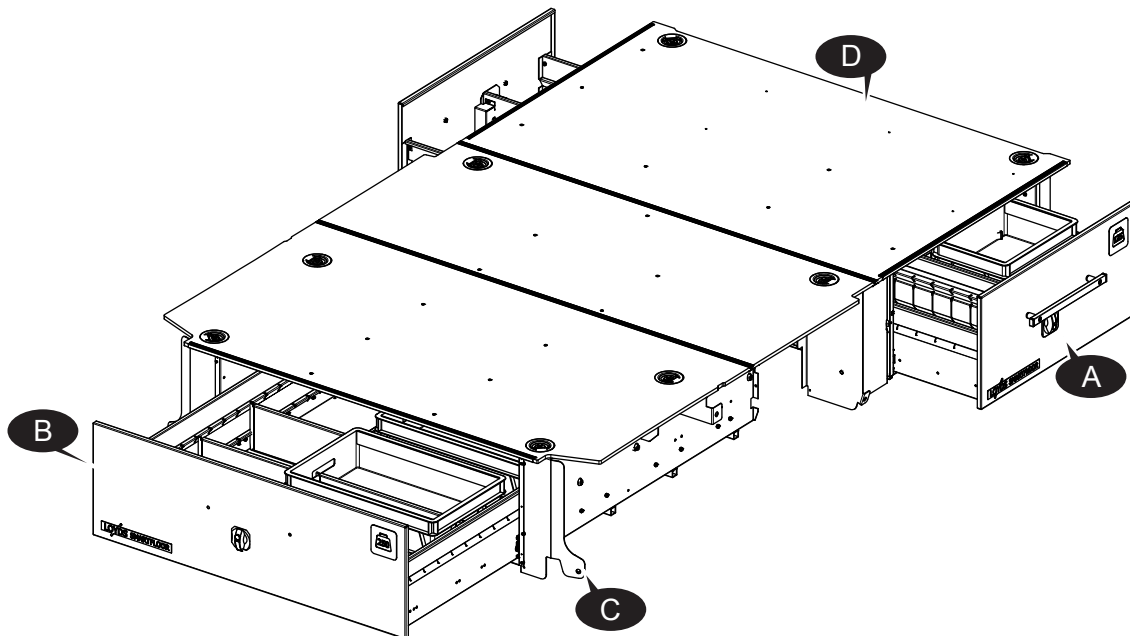

Item	Quantity	Part Number	Description
A	1	15009190	FD2 Front Drawer Complete Assy
B	1	15009300	RD Rear Drawer Complete Assy
C	1	15013338	Steel Bracket Set Ford Custom L2 2SLD
D	1	15013339	Floor Kit Custom L2 2SLD

## 15015200 Kit Complete Ford Custom L1 1SLD

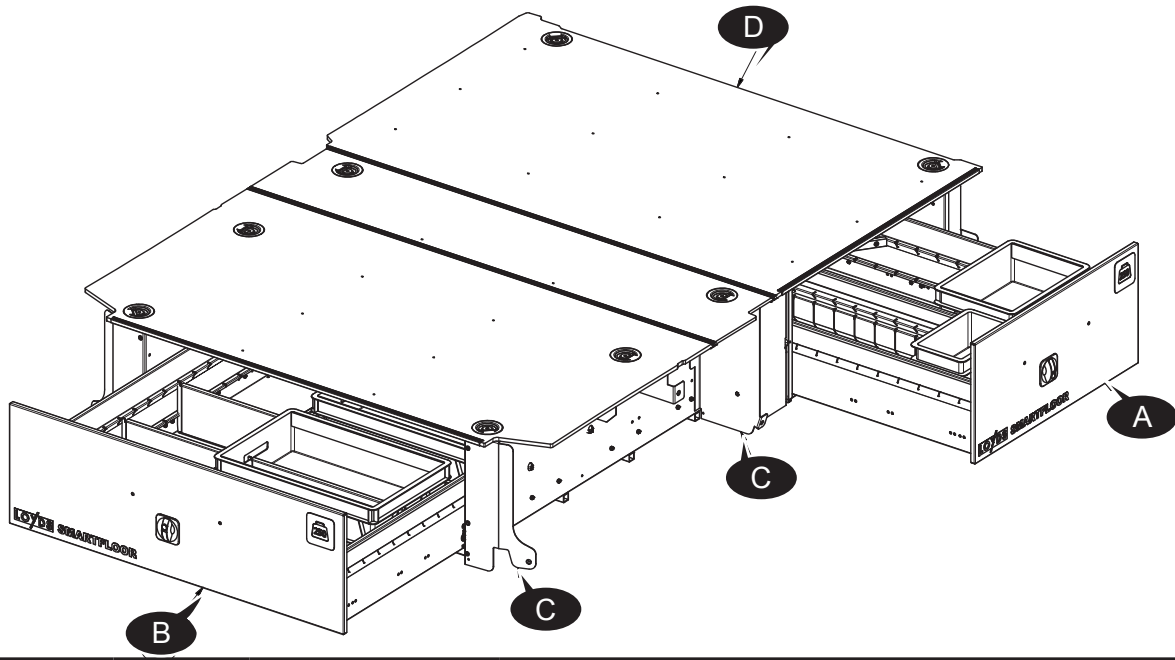

Item	Quantity	Part Number	Description
A	1	15009580	FD1 Front Drawer Complete Assy
B	1	15009300	RD Rear Drawer Complete Assy
C	1	15013303	Steel Bracket Set Ford Custom L1 2SLD
D	1	15015193	Floor Kit SF Custom L1 1SLD

## 15015201 Kit Complete Ford Custom L2 1SLD

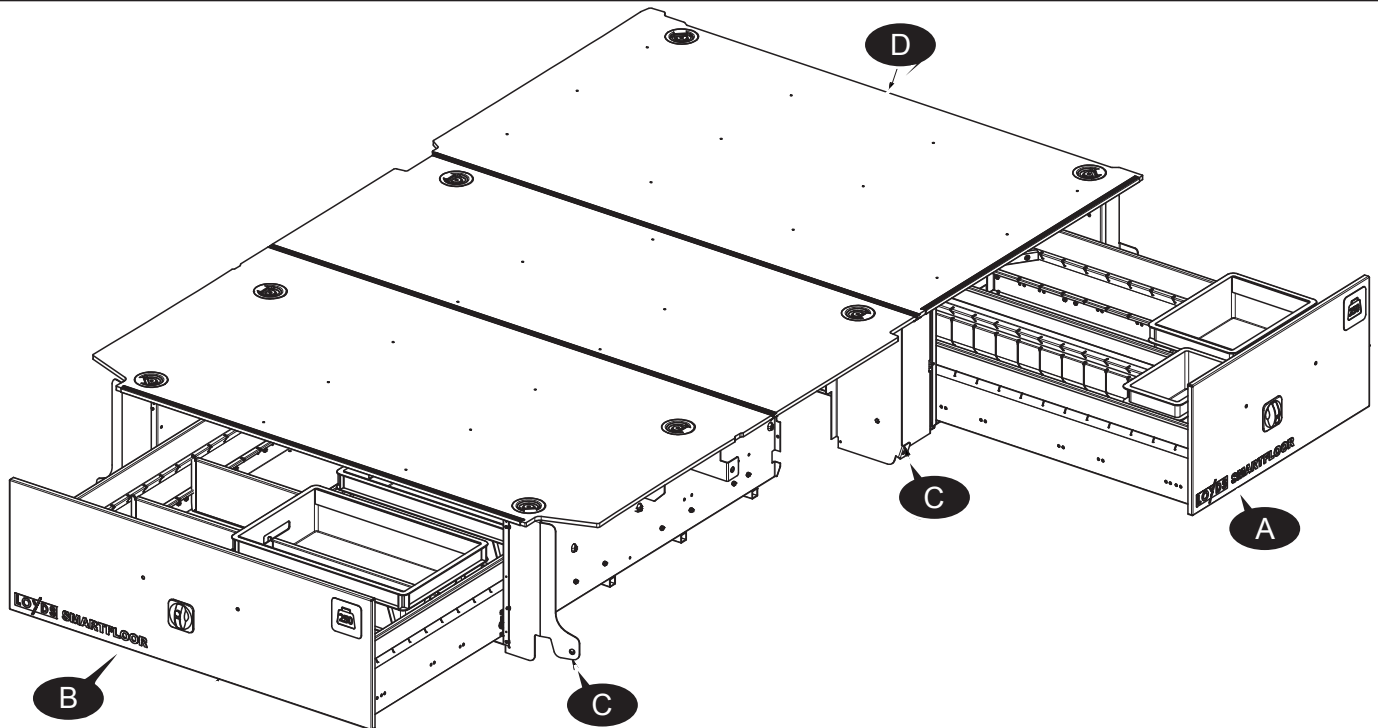

Item	Quantity	Part Number	Description
A	1	15009580	FD1 Front Drawer Complete Assy
B	1	15009300	RD Rear Drawer Complete Assy
C	1	15013338	Steel Bracket Set Ford Custom L2 2SLD
D	1	15015194	Floor Kit SF Custom L2 1SLD



## 15010236 Handle Assy

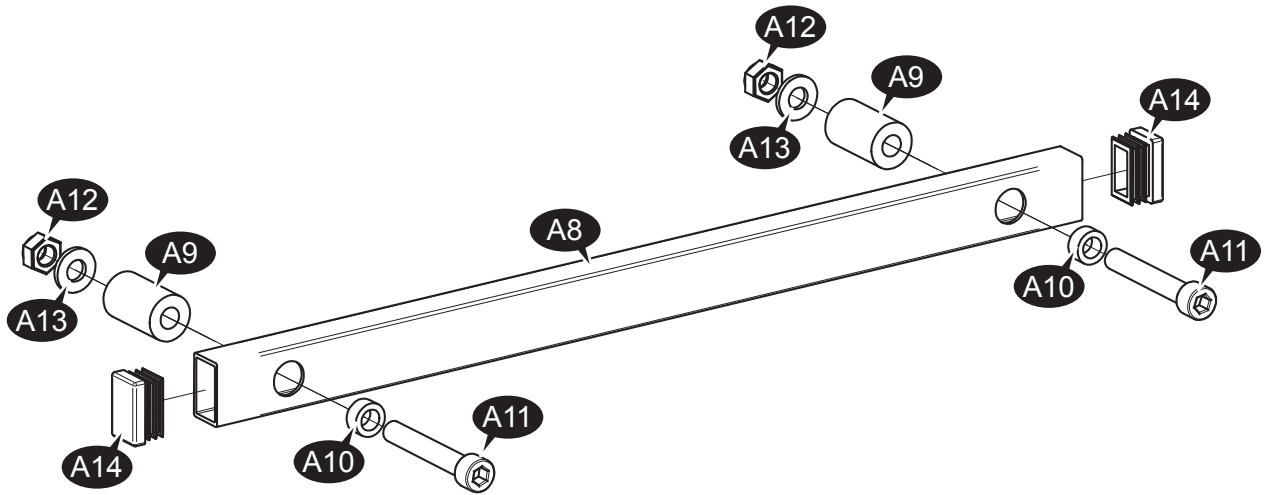

### 15010236 Handle Assy

Item	Quantity	Part Number	Description
A8	1	15009441	Handle Tube 25x15x286
A9	2	15009442	Spacer Ø8,3x18x30 Nylon Black
A10	2	15009443	Spacer Ø8,1x13x6mm Galv
A11	2	15009444	Screw M8x50 Cylinderh Hex
A12	2	8 NMU	Mutter M8 Nyloc DIN985
A13	2	8,4x17x2	M8 Washer, DIN 125
A14	2	15009438	End Plug Tube 25x15 Inside

### 15013301 Floor Kit Custom L1 2SLD

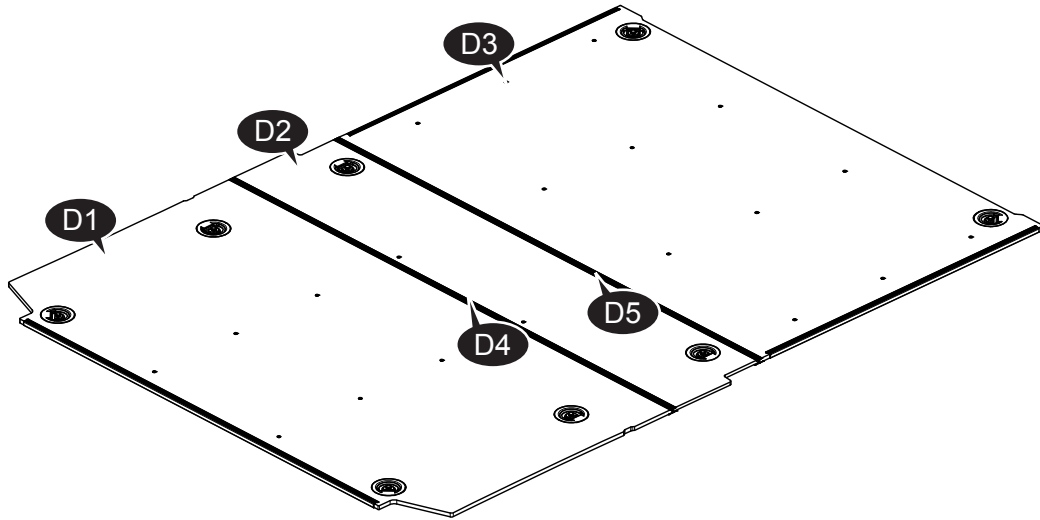

Item	Quantity	Part Number	Description
D1	1	15013330	Rear Floor Custom L1 ASSY
D2	1	15013318	Middle Floor Custom L1
D3	1	15013331	Front Floor Custom ASSY
D4	1	15013322	H-profile 12mm L=1714
D5	1	15013321	H-profile 12mm L=1643

### 15013339\_A Floor Kit Custom L2 2SLD

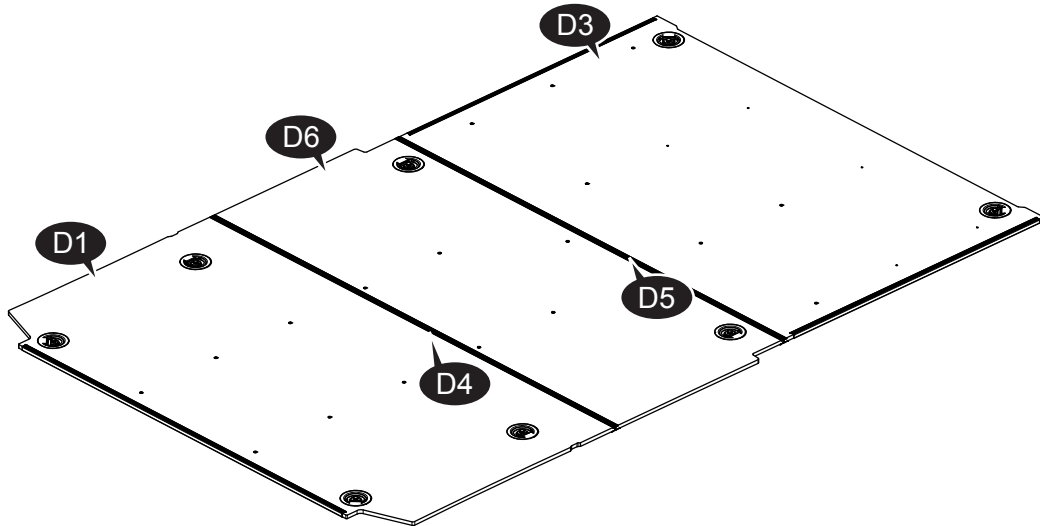

Item	Quantity	Part Number	Description
D1	1	15013330	Rear Floor Custom L1 ASSY
D3	1	15013331	Front Floor Custom ASSY
D4	1	15013322	H-profile 12mm L=1714
D5	1	15013321	H-profile 12mm L=1643
D6	1	15013337	Middle Floor Custom L2

### 15015193 Floor Kit Custom L1 1SLD

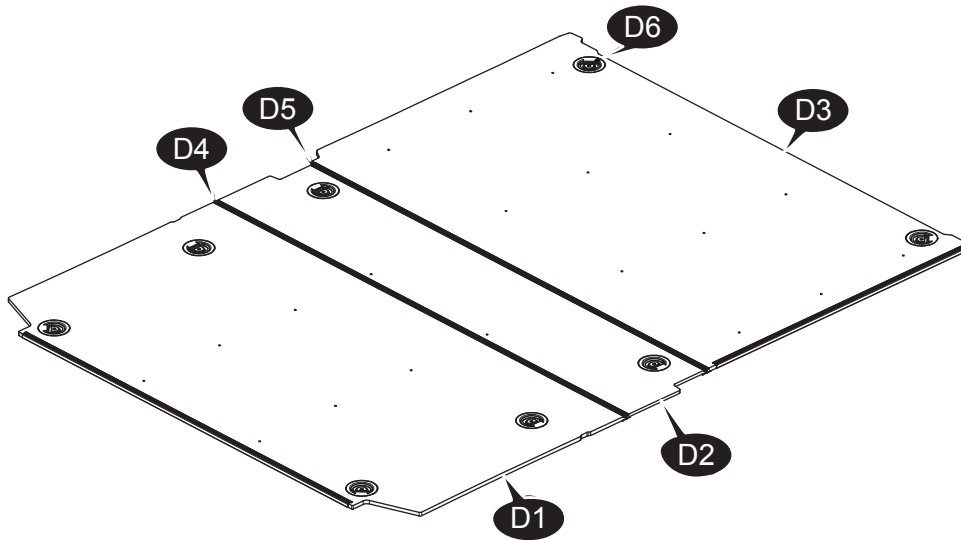

Item	Quantity	Part Number	Description
D1	1	15013330	Rear Floor Custom L1 ASSY
D2	1	15013318	Middle Floor Custom L1
D3	1	15015192	Front Floor Custom ASSY
D4	1	15013322	H-profile 12mm L=1714
D5	1	15013321	H-profile 12mm L=1643
D6	1	15013302	Fitting Kit Floor Set Custom

### 15015194 Floor Kit Custom L2 1SLD

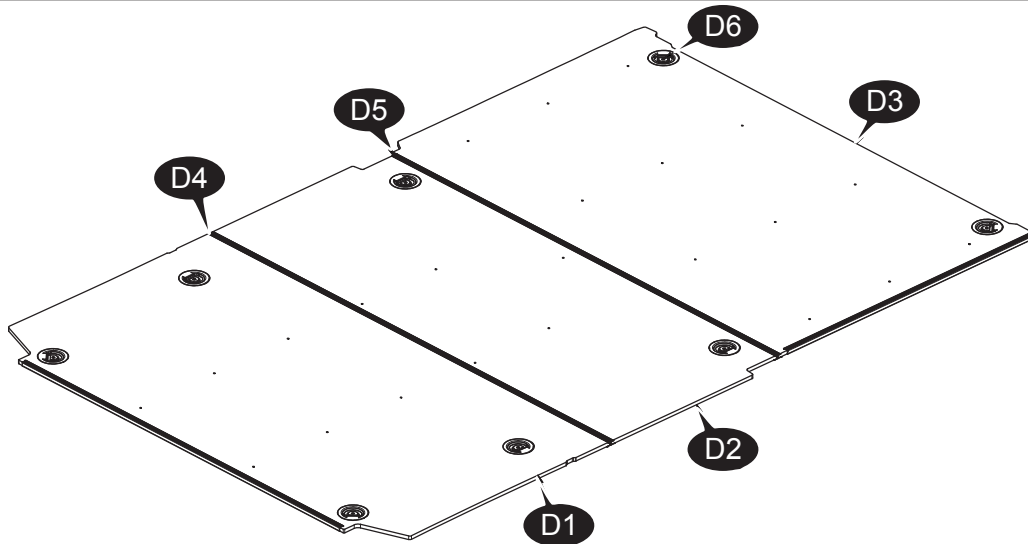

Item	Quantity	Part Number	Description
D1	1	15013330	Rear Floor Custom L1 ASSY
D2	1	15013337	Middle Floor Custom L2
D3	1	15015192	Front Floor SF Custom 1SLD ASSY
D4	1	15013322	H-profile 12mm L=1714
D5	1	15013321	H-profile 12mm L=1643
D6	1	15013302	Fitting Kit Floor Set Custom

## 15013303 Steel Bracket Set Ford Custom L1 2SLD

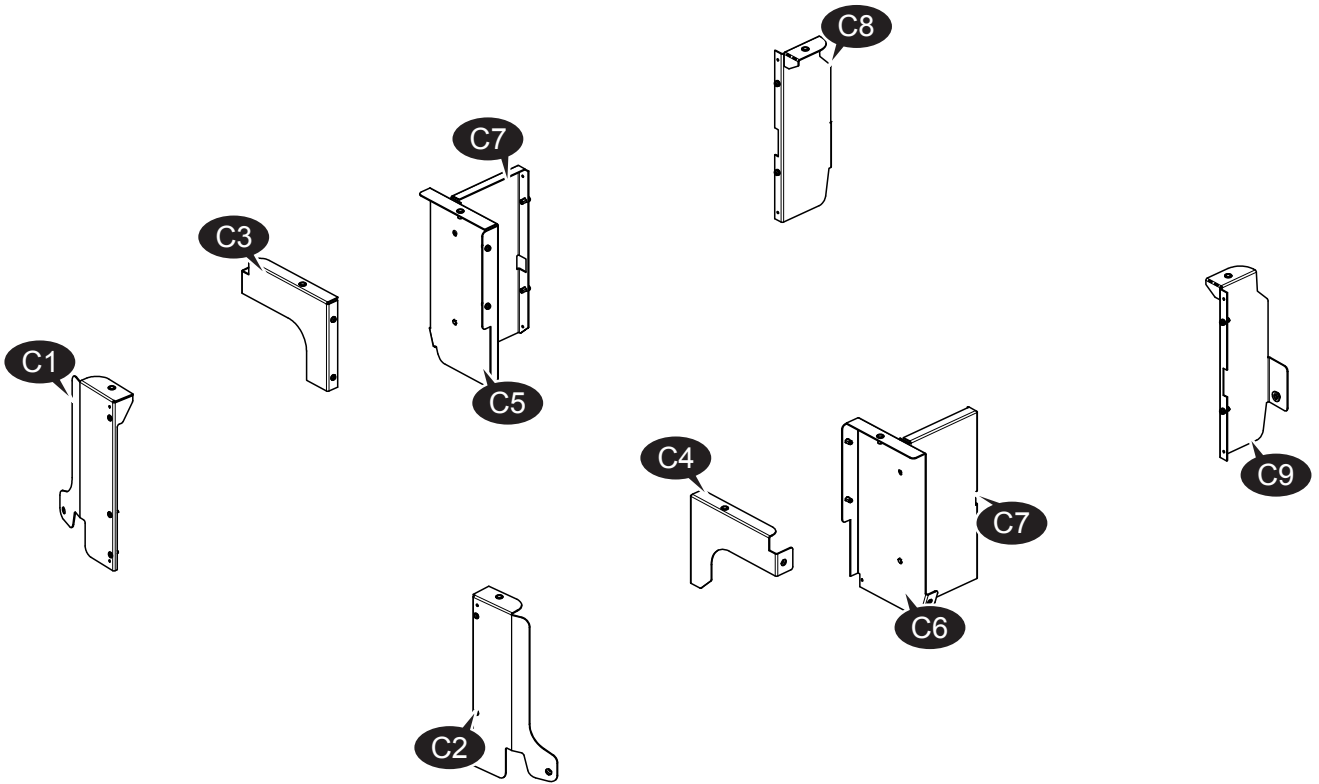

Item	Quantity	Part Number	Description
C1	1	15013314	Bracket Rear Left Custom ASSY
C2	1	15013316	Bracket Rear Right Custom ASSY
C3	1	15013326	Bracket Side Fix Rear Left Custom ASSY
C4	1	15013328	Bracket Side Fix Rear Right Custom ASSY
C5	1	15013310	Bracket Middle Left Custom ASSY
C6	1	15013312	Bracket Middle Right Custom ASSY
C7	2	15013324	Bracket Fix FD RD Custom ASSY
C8	1	15013306	Bracket Front Left Custom ASSY
C9	1	15013308	Bracket Front Right Custom ASSY

## 15013338 Steel Bracket Set Ford Custom L2 2SLD

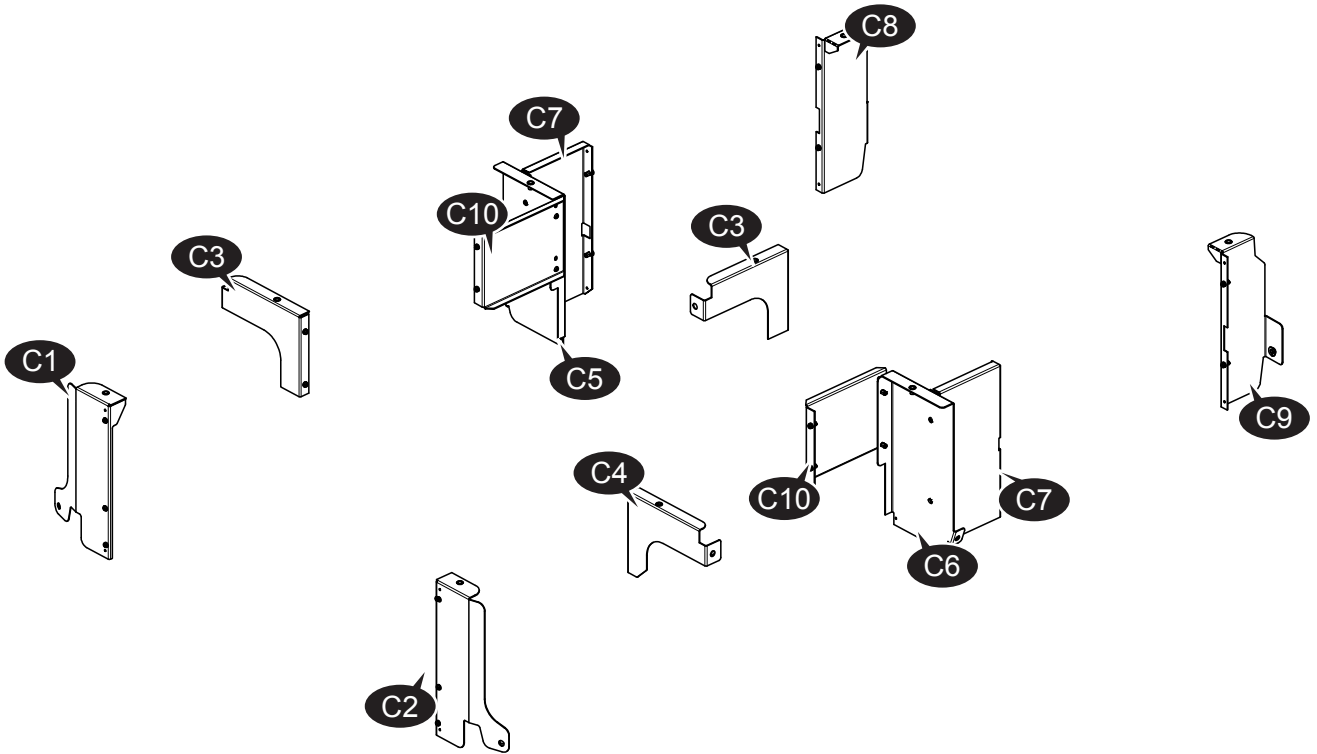

Item	Quantity	Part Number	Description
C1	1	15013314	Bracket Rear Left Custom ASSY
C2	1	15013316	Bracket Rear Right Custom ASSY
C3	2	15013326	Bracket Side Fix Rear Left Custom ASSY
C4	1	15013328	Bracket Side Fix Rear Right Custom ASSY
C5	1	15013310	Bracket Middle Left Custom ASSY
C6	1	15013312	Bracket Middle Right Custom ASSY
C7	2	15013324	Bracket Fix FD RD Custom ASSY
C8	1	15013306	Bracket Front Left Custom ASSY
C9	1	15013308	Bracket Front Right Custom ASSY
C10	2	15013336	Bracket L2 Fix Custom ASSY

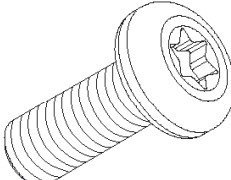
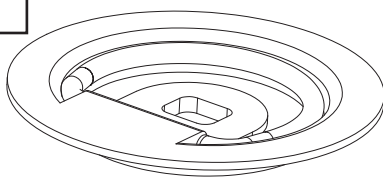
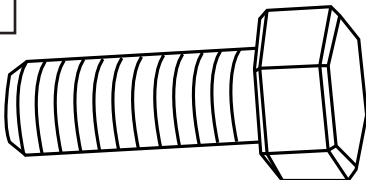
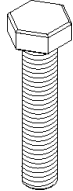
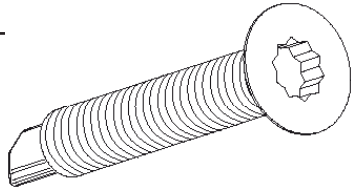
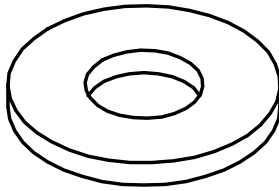
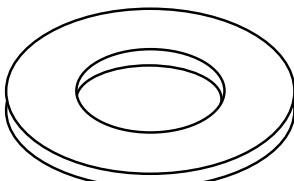
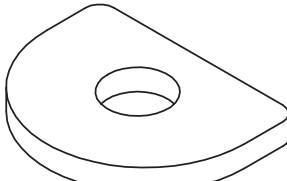

## Fitting Kit

<p><b>F1</b></p>  <p style="text-align: center;">15003551 M6x16 TX30 pan (DIN 7985)</p>	<p><b>F2</b></p>  <p style="text-align: center;">15005497 Latch Cup Black Ø90 Ø12x15 1000Kp</p>	<p><b>F3</b></p>  <p style="text-align: center;">6x16 6k M6 Bolt, DIN 933</p>
<p><b>F4</b></p>  <p style="text-align: center;">8x40 M8x40mm Bolt, DIN 933, sort</p>	<p><b>F5</b></p>  <p style="text-align: center;">15009568 Screw 4,8x32 Selfdrill Counters Torx Elz</p>	<p><b>F6</b></p>  <p style="text-align: center;">15009916 Washer 30x13x3 Elz</p>
<p><b>F7</b></p>  <p style="text-align: center;">7-16x1mm Washer Washer 7/16"x1mm elzn</p>	<p><b>F8</b></p>  <p style="text-align: center;">15005884 Washer Latchcup for Ø8</p>	<p><b>F9</b></p>
<p><b>F10</b></p>	<p><b>F11</b></p>	<p><b>F12</b></p>
<p><b>F13</b></p>	<p><b>F14</b></p>	<p><b>F15</b></p>
<p><b>F16</b></p>	<p><b>F17</b></p>	<p><b>F18</b></p>
<p><b>F19</b></p>	<p><b>F20</b></p>	<p><b>F21</b></p>

1.

L&R

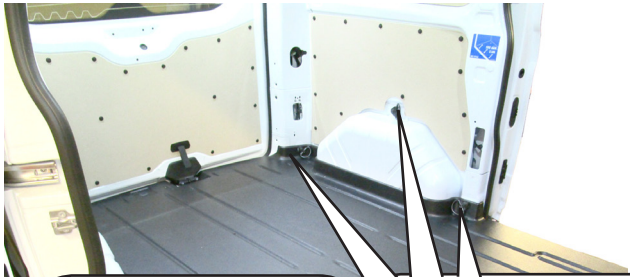

(x8)



(x8)



2.

L&R

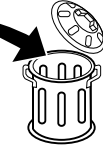

3.

Back door

L&R

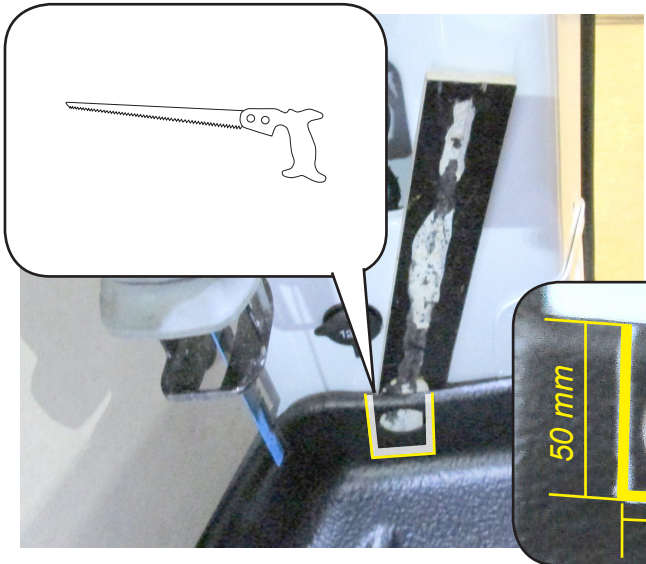

4.

Slide door

L&R

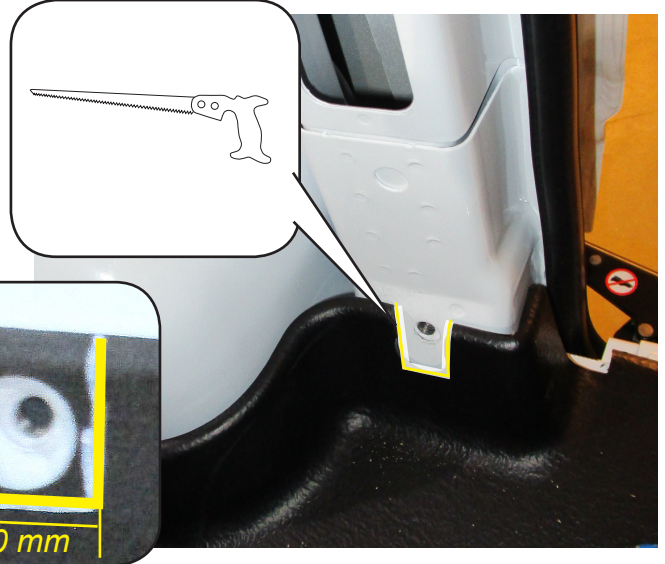

5.

Front drawer

6.

Rear drawer

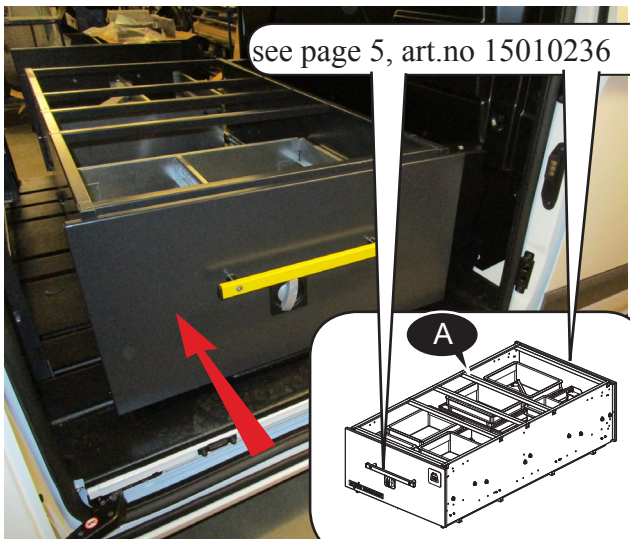

see page 5, art.no 15010236

A

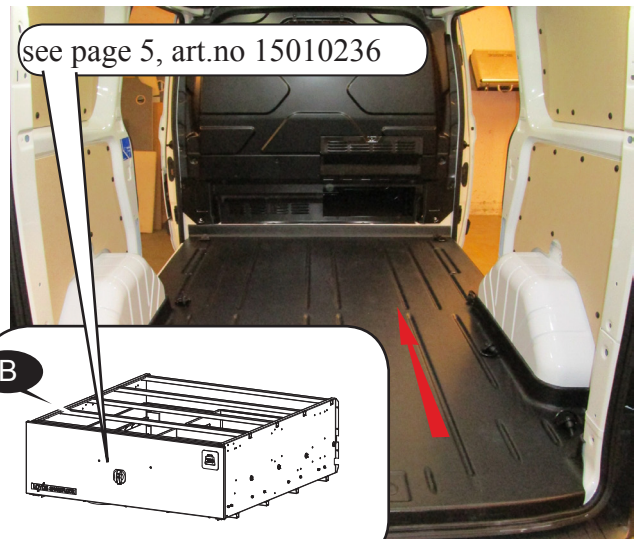

see page 5, art.no 15010236

B



7.

L&R

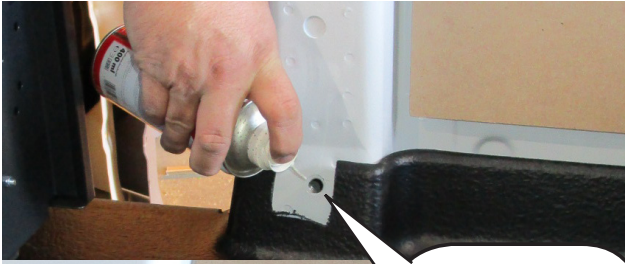

**Lubricant**



Apply to:  
All bolts & holes

8.

L&R

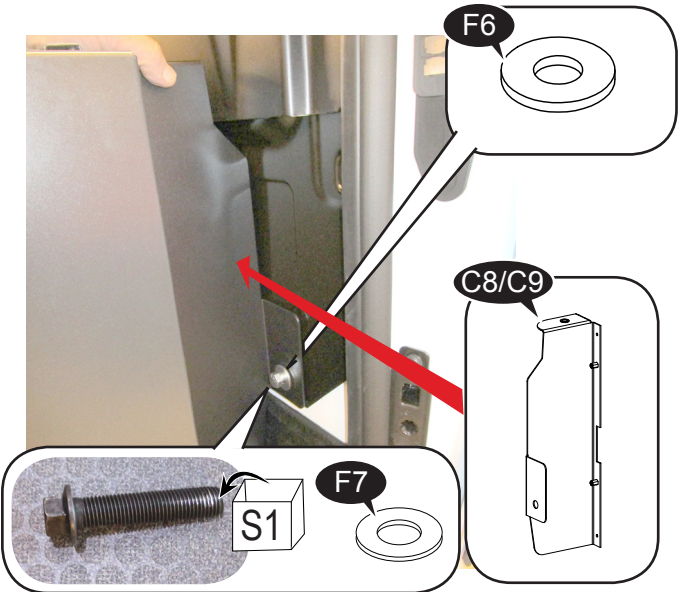

F6

S1

F7

C8/C9

9.

L&R

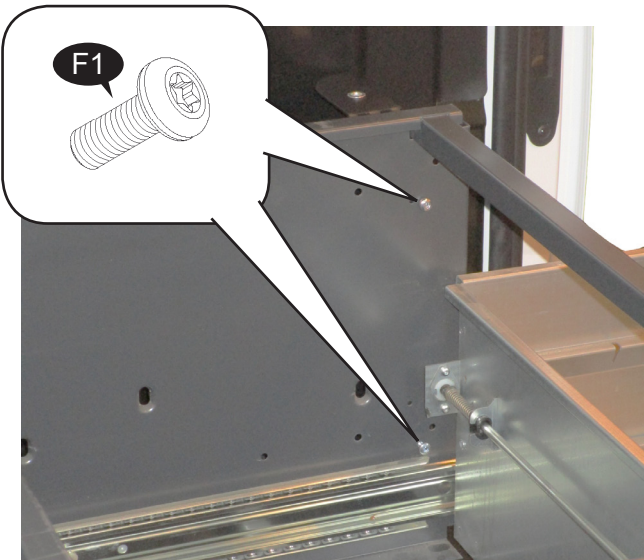

F1

10.

Slide door

L&R

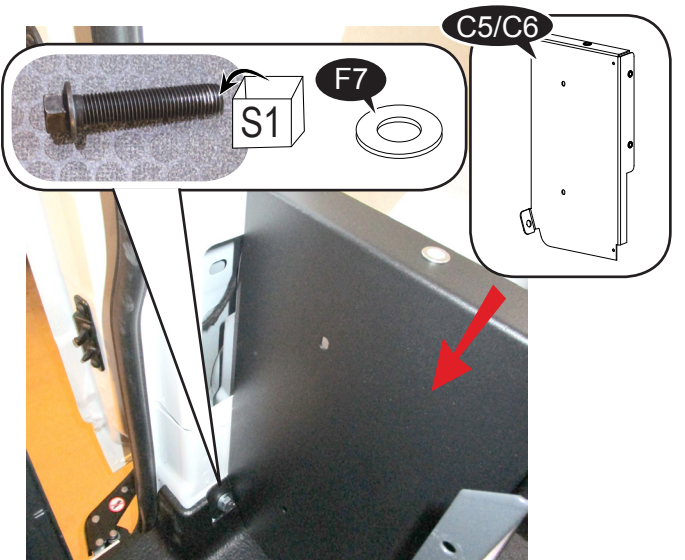

S1

F7

C5/C6

11.

L1 2SLD

L&R

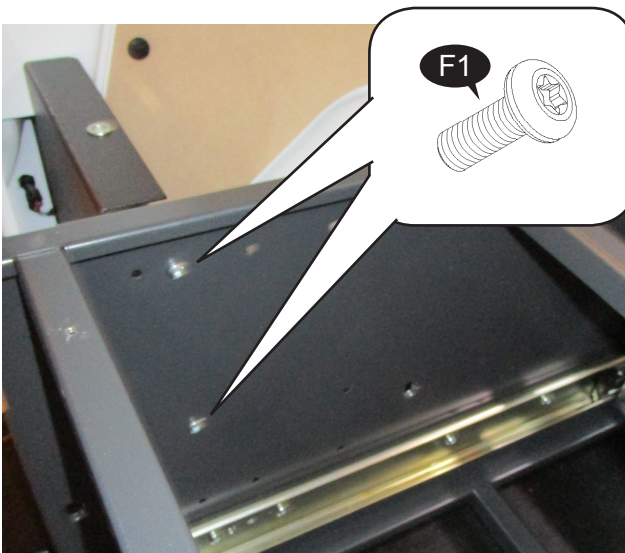

F1

12.

L2 2SLD

L&R

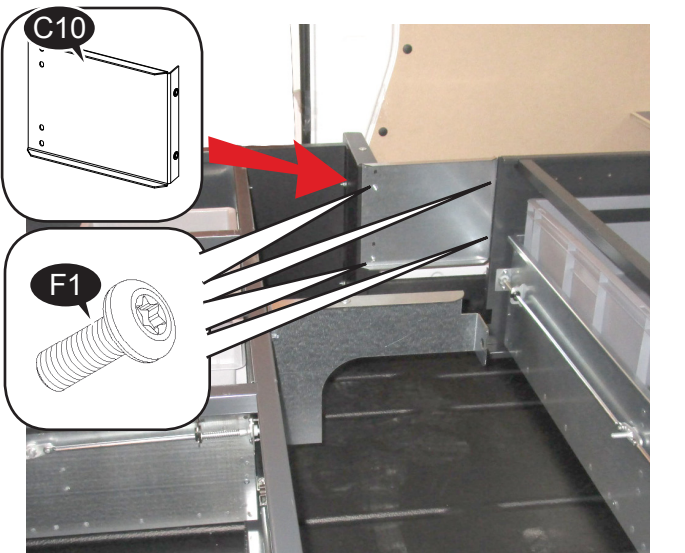

C10

F1



13.

L&R



14.

L&R

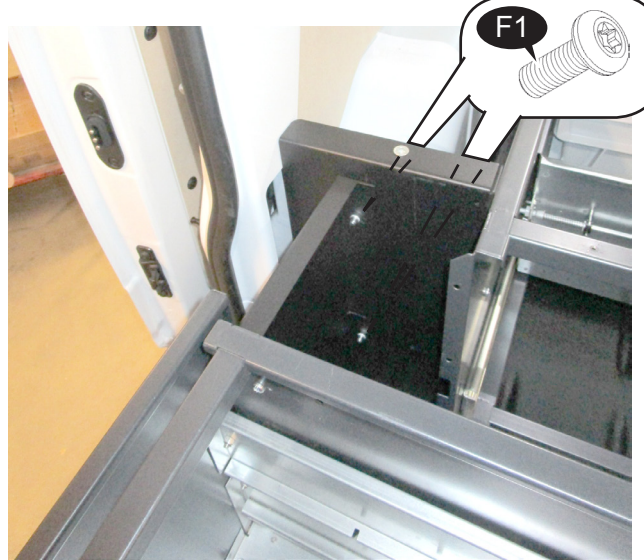

15.

L&R

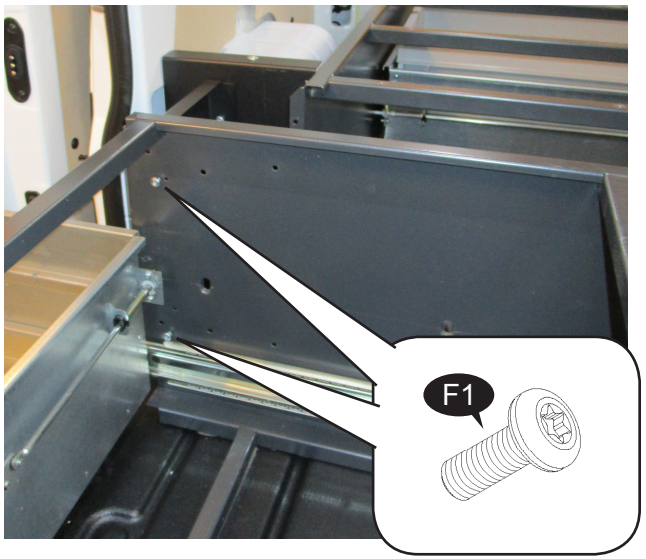

16.

L&R

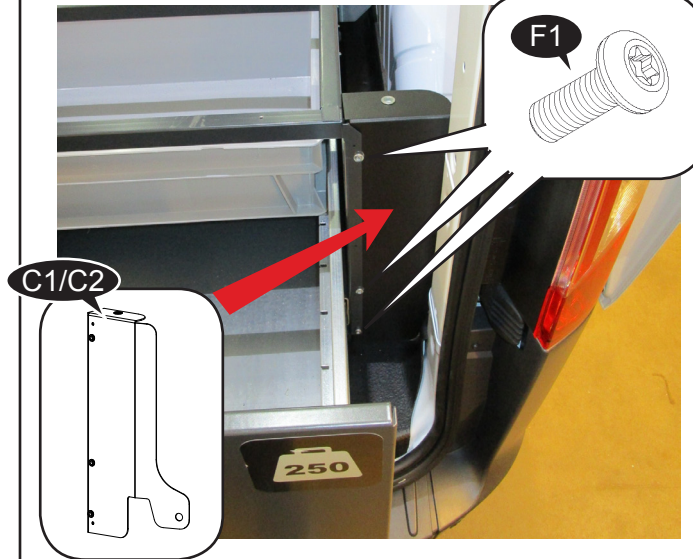

17.

L&R

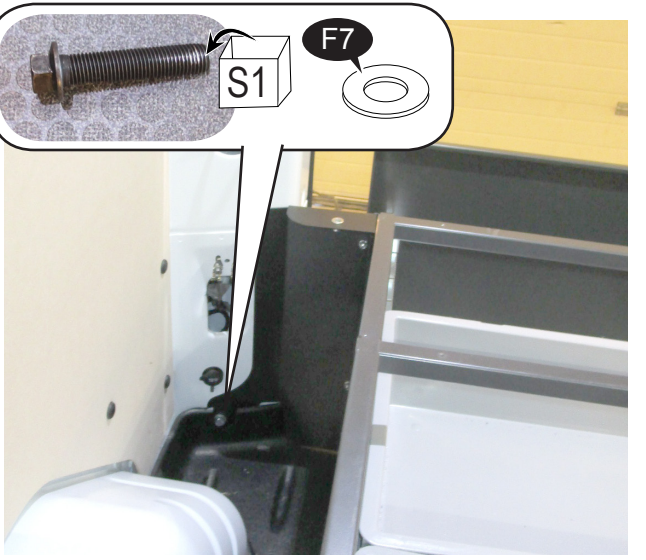

18.

L&R

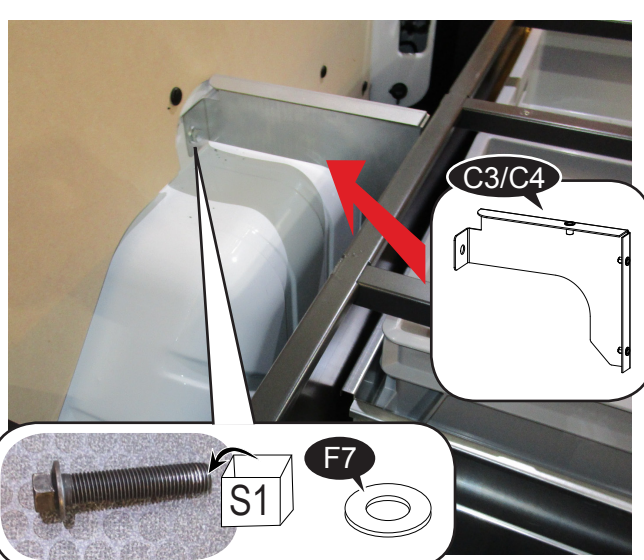



19.

L&R

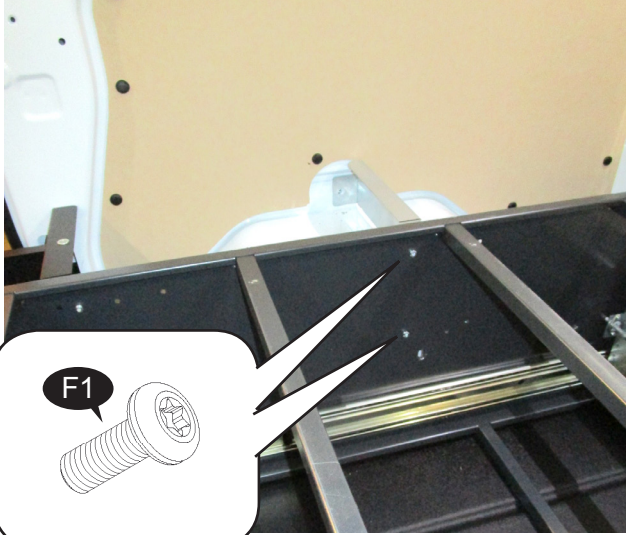

20.

L2 2SLD

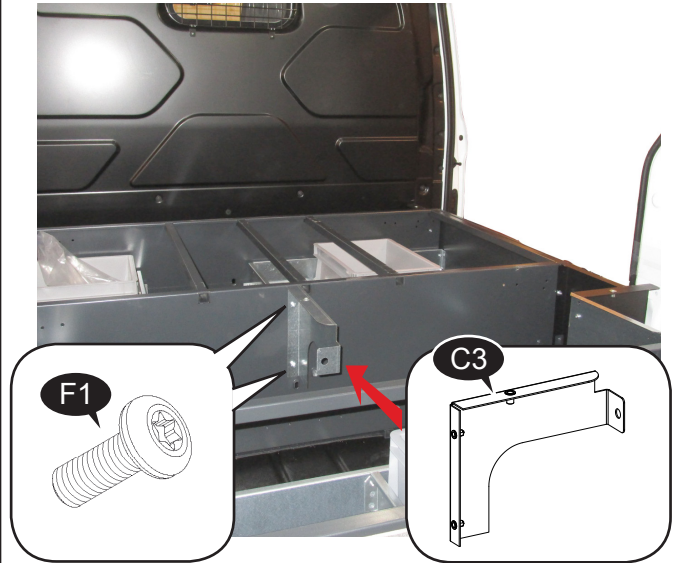

21.

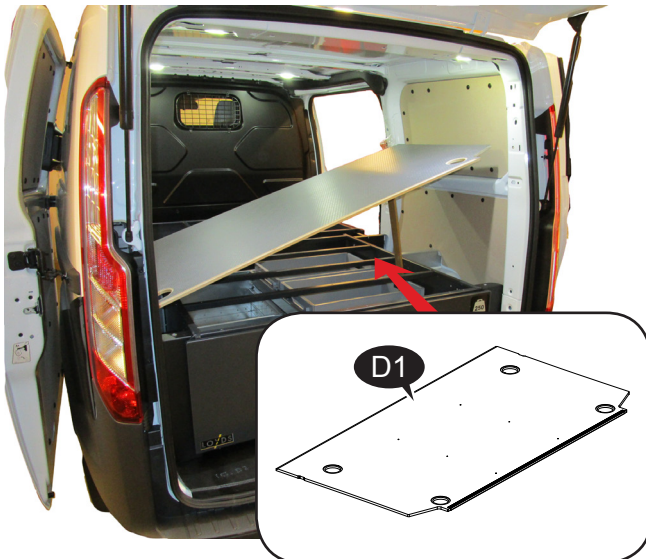

22.

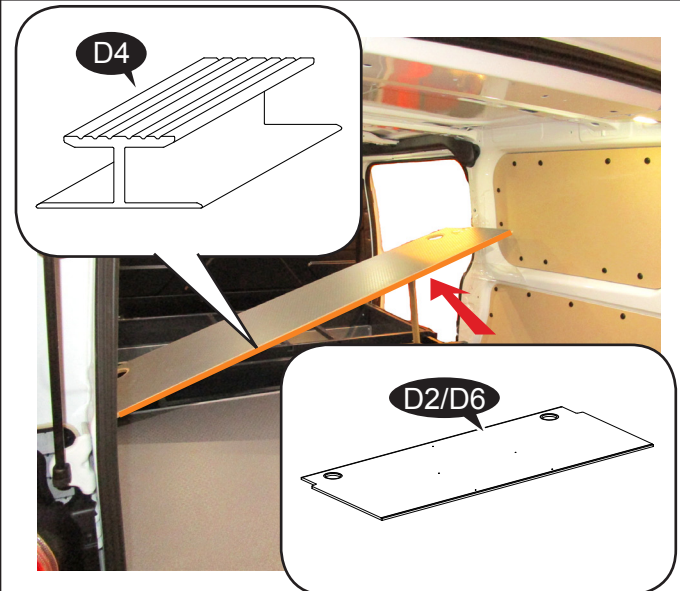

23.

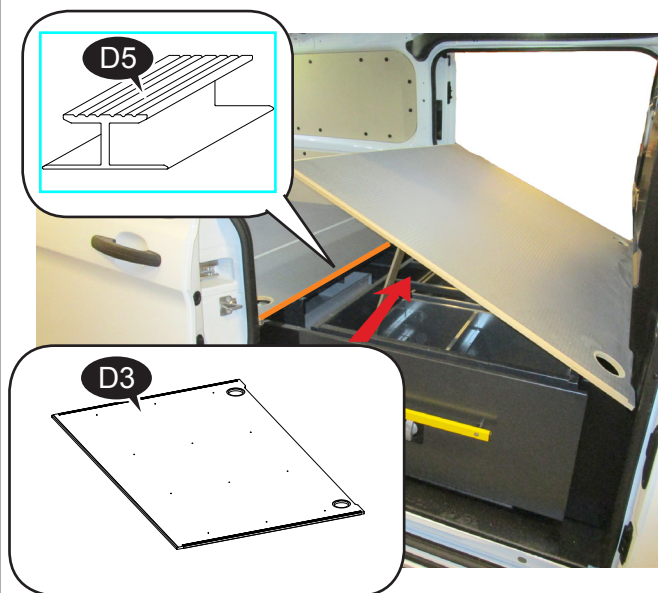

24.

