

FORNACE BRIONI TERRACOTTA—WALL

USAGE	Y/N
interior floor	N
interior wall	Y*
exterior floor	N
exterior wall	Y*
residential light traffic	N
commercial light traffic	N
radiant heating compatible	Y
fireplace surround	Y
shower	N
steam shower	N
fountain	N
freeze thaw	N
pool	N
heat resistant	N
sink backsplash	N
stove backsplash	N
grout type	flexcolor cq
grout joint size	1/8" – 3/8"
UV resistant	Y

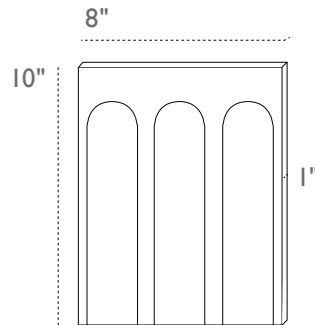
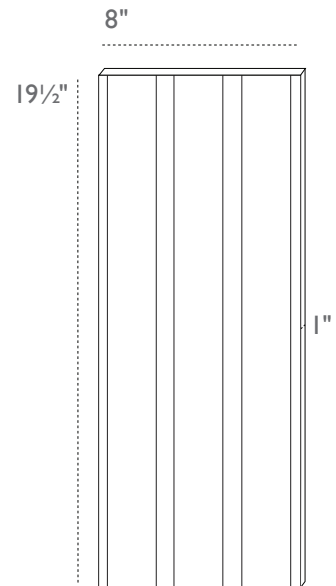
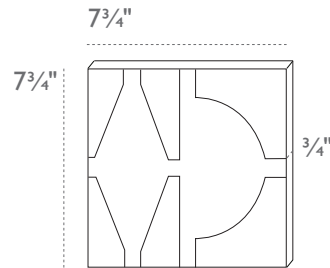
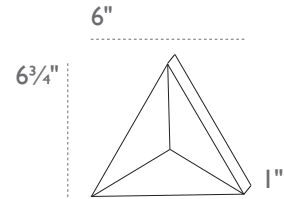
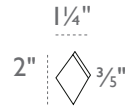

Standard thickness for Trama is 3/5", for Mantegna and Giulio Romano 1", and for Acanti 3/4"
Please note all dimensions are nominal and can vary +/- 1/4" for Acanti and Giulio Romano,
+/- 1/8" for Trama and Mantegna.

* There are specific installation requirements for this usage, read more information under the installation, sealing, grout, and wet area application sections of this document.

FORNACE BRIONI TERRACOTTA—WALL

INSPECTING YOUR SHIPMENT

- All Fornace Brioni tiles are made by hand, therefore slight variations in thickness, depth, color, shade and size to be expected.
- Calcium flashing can occur on terracotta tiles but generally comes off by itself during the installation process. If needed, calcium deposits can be removed via a quick wet sanding before grouting/sealing the tiles.
- **IMPORTANT:** Due to the noticeable color and shade variations, it is very important to blend the tiles from all boxes once they arrive and place them in their installation area to ensure you have the layout you want before installing. Do not install without blending tiles from all boxes.
- Industry standard suggests adding at least 15% overage due to tile cuts, potential breakage, or future repairs.
- Dust and residue from shipping should be cleaned prior to installing. This can be done with a damp sponge or microfiber cloth.

INSTALLATION

- As is standard in the tile industry, installation deems acceptance of materials. Do not install if there are visible issues. If you have any doubts or are unsure of what qualifies as a visible issue for the tile you are installing, please reach out to us prior to installation. Our tiles are subject to variations in color, texture, size and finish. Do not install if you have any doubts about visible issues. Misuse by contractor or end-user including but not limited to negligence, physical and/or chemical abuse is not covered by clé's warranty.
- Tile is merely the surface of your construction. Installation problems will arise from substrate or construction engineering and/or installation issues. Please refer to your project architect, structural engineer and/or installer to have the best results for your tile finish.
- clé's guides are only to help direct you in the right path for a proper installation. Each project is unique and therefore requires a professional who can provide the exact specifications for your project.
- Please refer to the current edition of the TCNA Handbook for best installation results and ANSI A137.1 American National Standard Specifications for Ceramic Tile to reference for specifications.
- To ensure proper bonding when setting, we recommend lightly wiping the back of each tile if there is excessive dust.
- Be sure to have 95% or more adhesive on the back of the tile to ensure the best bond when setting.
- **DO NOT USE TAPE** during product installation, or otherwise. We cannot guarantee our products' safety against various construction tapes—**INCLUDING BLUE TAPE.**

SEALANT

- Fornace Brioni terracotta tiles are extremely porous and must be sealed after grouting to maintain their appearance and avoid staining.
 - clé only recommends [Miracle 511 Porous Plus](#) for an invisible, water, stain and weather resistant sealant finish.
 - Always test sealers in a small area to ensure it provides the finish you prefer.
 - For exterior wall applications, you must seal the grouted areas and the tile surface as the final step of installation.
 - If your contractor is having any issues or questions regarding this sealant, please have them reach out to Miracle tech support directly at 1-877-385-8155, as they are the best and fastest line of resolution.
 - PLEASE FOLLOW ALL MIRACLE SEALANT INSTRUCTIONS FOR BEST RESULTS as well as MAINTENANCE UPKEEP RECOMMENDATIONS.*
- * **HINT:** if water and oil do not bead up on the surface of your tiles then the sealant was not applied properly.

RECOMMENDED GROUT JOINT SIZE

- trama cotto bianco: 1/8"
- trama cotto rosato: 1/8"
- trama grey cotto Ø1: 1/8"
- trama grey cotto ØØ: 1/8"
- mantegna grey cotto Ø1: 1/8"
- mantegna cotto rosato: 1/8"
- mantegna cotto bianco: 1/8"
- acanti: 1/8"
- giulio romano cotto rosato: 1/8"

GROUT

- Grouting is generally not done for dry applications of Acanti, Mantegna, Trama and Giulio Romano, but if you prefer to grout, then use a grout bag to fill the joints due to the shape and depth of the tile.
- Exterior installations (walls in non freeze/thaw areas) need to be grouted.
- Because of the thickness and shape of the tile it may be easier to use a grout bag to fill the grout joints. You will still need to pack the grout in with your fingers. We recommend working in small areas to fill the grout joints.
- Smooth the grout over the filled grout lines with your finger instead of using a trowel—due to the unique shapes of the tiles.
- Remove excess grout with a clean, slightly damp sponge.
- After grouting, clean any remaining spots of grout from the surface.
- Follow grout manufacturer's instructions on proper drying time before applying final sealant.
- clé ONLY recommends [Mapei Flexcolor CQ](#) grout to reduce the risk of grout haze and staining. Make sure to always follow the manufacturer's instructions. Letting the grout sit for even a short period of time can be problematic.

- Grout color selection is always up to our client and/or their design professional. However, clé is often asked for our opinion on best grout selections for our tiles. And due to the large array of grout colors that are now available, clé would like to offer this general guideline on a foolproof grout color selection for any of your clé tiles.
 - First, have your professional tile contractor complete your tile installation, except for the grout portion.
 - Next, when ready to grout, ask your contractor to bring ALL grout color charts from his preferred grout manufacturers, for your review.
 - Lastly, choose a time of day when you are most pleased with the lighting in your space (either natural lighting, installed lighting or a blend of both). During that lighting and time of day, select the grout color that best matches your tile selection.
- Note that the full Mapei Flexcolor CQ color catalogue contains 40 colors to choose from. Visit the [Mapei website](#) to view.
- If you are working with a highly color-variegated tile or a combination of tiles (checkered or otherwise), we recommend that you follow the above recommendations—but match your grout to the color in your varied tile or tile combination that you would most like to accentuate.
- If your contractor selects brands other than Mapei grout or Miracle sealant, please have them reach out to the respected representatives of those manufactures for advice and support on failures.
- If your contractor is having any issues or questions regarding this grout, please reach out to Mapei tech support directly at 1-800-992-6273 as they are the best and fastest line of contact.
- **IMPORTANT:** During grout application, immediately remove any excess grout off the face of the tile with a clean, damp cloth/sponge. Do not allow grout to cure on the face of the tile as it could cause grout haze and will be hard to remove.

EXTERIOR
INSTALLATIONS

- **IMPORTANT:** Fornace Brioni terracotta tiles are not freeze thaw rated. Therefore we do not recommend and cannot warrant installing these outdoors in areas that regularly experience freezing temperatures*

* If you plan on installing these outdoors in areas that experience freeze/thaw, we cannot guarantee there won't be installation failures. Installations in freeze/thaw locations require flashing the top of vertical installations to prevent moisture from dripping behind the installation. In addition, the installation must be completely sealed and maintained with a weather resistant sealant like Miracle 511 Porous Plus.

With application of Miracle Sealant, these tiles can have resistance to freeze/thaw issues. However, oftentimes there are installation failures because the specific installation guidelines and sealant maintenance is not properly followed. But if completed and maintained correctly (see manufacturer's instructions) then you can proceed WITH CAUTION.

If you can comply with all of the above and understand that without the sealant your install won't hold up—then it's up to you to proceed with installing this tile in a freeze/thaw location. We recommend your contractor reach out to both Mapei tech support for installation support and Miracle Sealant tech support on the waterproofing of the tiles.

WET AREA APPLICATION

Due to the porous nature of these tiles, we do not recommend them for sink backsplash, shower, pool, fountain or any other type of wet area application.

MAINTENANCE

- Reapplication of sealant is required for exterior applications for waterproofing, and for interior applications as an aid for easier cleaning.
 - Check with the Miracle Sealant tech support directly at 1-877-385-8155 for best advice on applying and maintaining sealants.
-

CLEANING

- Immediately clean up spills—do not allow liquids to sit on the tile surface. Excess liquid and moisture can stain, pit and crack tile—even when properly sealed.
- Mild, pH neutral soaps should be sufficient for most cleaning—test before general use.
- Clean using soft materials, like a cloth, instead of coarse materials.
- Always avoid harsh chemicals and acidic or alkaline cleaning products.
- Dust and/or wipe down regularly.
- Most stains can be removed with a pH neutral dish soap, hot water and the scrub side of a sponge.
- clé recommends the use of Miracle Porcelain & Ceramic Tile Cleaner to remove stubborn stains, grease build up, soap scum, hard water deposits and everyday grime.
- Miracle Tile & Stone Cleaner is effective as an ongoing maintenance cleaner and is gentle for everyday use.
- To remove difficult mildew, mold or soap scum, we recommend Miracle Sealants Liquid Powlitice.
- Oil stains are difficult to remove from terracotta. They will require the use of a poultice, like Miracle Sealants Powlitice Plus to draw out the stain. Follow the manufacturer's instructions for application and use.
- Grout lines can be cleaned with warm water and a soft bristled cleaning brush.

FORNACE BRIONI TERRACOTTA TRADE SPECIFICATIONS

What’s in our tile: Fornace Brioni features an extraordinary collection of both traditional terracotta and glazed ceramic tiles made in collaboration with architect and designer Cristina Celestino. The traditional terracotta - or cotto - heralds from Gonzaga, a small town in the Lombardy region of Italy steeped in renaissance history and renowned for its terracotta. These tiles are still created by hand by the family-run company, now in its third generation, headed by Alberto Brioni. Created from the finest clays from the floodplain of the river Po, cotto is nothing more than the combination of water and earth that when exposed to fire, creates a subtle alchemy that becomes embodied in each tile. Both natural and ecological, each hand-made tile is unique and offers the best of Italian craftsmanship.

COLOR AND TEXTURE VARIATION

All Fornace Brioni terracotta wall tiles are rated ‘level 2 light’ for color variation and ‘level 3 medium’ for texture variation. For size variation Trama and Mantegna are rated as ‘level 2 medium’, and Acanti and Giulio as ‘level 3 heavy’.

Due to the handmade craftsmanship of many of our tiles and the variety of materials used, there are degrees of variation in our tiles color, shade and texture. These differences are more pronounced in certain types of tiles than others, especially in tiles from separate production lots, or “batches”.

The following is a guide for the different degrees of variation that we have assigned our tiles:

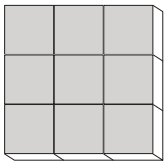
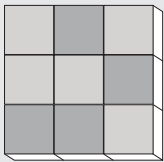
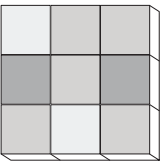
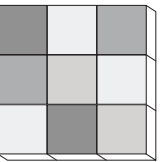
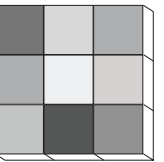
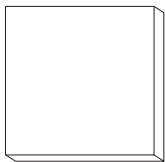
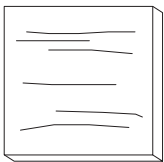
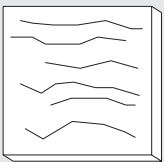
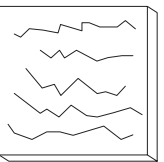
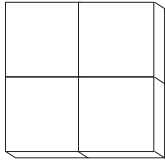
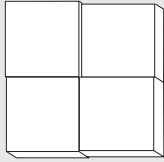
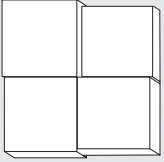
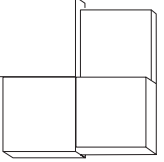
CATEGORY	LEVEL 1	LEVEL 2	LEVEL 3	LEVEL 4	LEVEL 5
COLOR VARIATION	 <p>low</p>	 <p>slight</p>	 <p>medium</p>	 <p>heavy</p>	 <p>extreme</p>
TEXTURE VARIATION	 <p>smooth</p>	 <p>slight</p>	 <p>medium</p>	 <p>heavy</p>	n/a
SIZE VARIATION	 <p>slight</p>	 <p>medium</p>	 <p>heavy</p>	 <p>extreme</p>	n/a

PRODUCT DESCRIPTION	Non-vitreous terracotta tiles, which are hand formed, and fired.	
PRODUCT COMPONENTS	Clay	
DIMENSIONS	Trama Mosaic	3.2 cm x 5.1 cm x 3.8 cm per tile (1 1/4" x 2" x 3/5" per tile) / .01 kg per tile (.03 lb)
	Mantegna Triangle	15.2 cm x 17.1 cm x 2.5 cm (6" x 6 3/4" x 1") / .45 kg per tile (1 lb)
	Acanti	19.7 cm x 19.7 cm x 1.9 cm (7 3/4" x 7 3/4" x 3/4") / 1.18 kg per tile (2.6 lbs)
	Giulio Romano –Endcap	20.3 cm x 25.4 cm x 2.5 cm (8" x 10" x 1") / 1.36 kg (3 lbs)
	Giulio Romano –Column	20.3 cm x 49.5 cm x 2.5 cm (8" x 19 1/2" x 1") / 9.95 kg per tile (6.5 lbs)
	* Please note all dimensions are nominal and can vary +/- 1/4" for Acanti and Giulio Romano, and +/- 1/8" for Trama and Mantegna.	
AVERAGE COEFFICIENT OF FRICTION (DCOF ACUTEST)	DCOF testing is not performed as these are strictly wall tiles.	
FREEZE/THAW RESISTANCE (ASTM C1026)	Fornace Brioni terracotta tiles are not freeze/thaw resistant.	
WATER ABSORPTION (ASTM C373)	avg. 26.4%; non-vitreous.	
ACID RESISTANCE	Fornace Brioni tiles are not resistant to acids and should be cleaned with pH neutral cleaners.	

LEED CREDITS

The product is an inherently non-emitting source of VOCs (stone, ceramic, metals, powder-coated metals, plated or anodized metal, glass, cement, clay brick, and unfinished or untreated solid wood) and has no integral organic-based surface coatings, binders, or sealants.

Fornace Brioni tiles are considered ‘inherently non-emitting sources’ under the Low-emitting Materials Credit of LEEDv4/v4.1. **This is currently the only credit for our Fornace Brioni tile that is eligible to be used toward LEED.**

‘Inherently non-emitting’ means that these tile types have been shown to not contribute emissions to indoor environments and are therefore exempt from demonstrating compliance with CDPH v1.1-2010 or CDPH v1.2-2017.

Use of these tiles as Wall or Flooring materials should be entered in the LEED v4.1 low-emitting materials Calculator and identified as ‘inherently non-emitting’ in the Products Tab (Column L).

Disclosures for MR Credit Material Ingredient Disclosures under LEEDv4/v4.1, are not available at this time. We are exploring our disclosure options and have not established a timeline for completion.

Disclosures for MR Credit Environmental Product Declarations under LEEDv4/4.1, are not available at this time. We are exploring our disclosure options and have not established a timeline for completion.

Contribution to MR Credit Material Sourcing under LEEDv4/v4.1, does not apply as there is no recycled content, no bio-based materials, no wood, no reused products included in our tile at this time. Extended producer responsibility programs are highly difficult to manage given the nature of end-of-use tile removal methods. *Tile can last hundreds of years but fashions often change, which is the dominant reason for its removal. We work hard to ensure our terracotta tiles can withstand the test of time while remaining timeless.*

RECYCLED CONTENT

There is no recycled content in our Fornace Brioni tiles at this time. See Material Sourcing disclosure above.

PERCENTAGE OF PRE-CONSUMER AND/OR POST-CONSUMER MATERIALS

There is no pre-consumer or post-consumer material content in our Fornace Brioni tiles at this time. See Material Sourcing disclosure above.

FIRE RATING

Typically, ceramic tile does not need to have fire rating testing performed. It is our understanding from TCNA that the explanation that ceramic is inorganic, inert, and typically free of materials that could burn or produce smoke is generally enough to satisfy a specifier and that testing is not necessary. Also, the temperatures observed in the testing are typically lower than the temperatures at which ceramic tiles are fired.

Terracotta is a ceramic tile and falls under the description, “because ceramic tile is non-flammable and does not produce smoke in a fire, it inherently meets the flame spread and smoke development requirements of Section 803 of the International Building Code (IBC) for interior wall and ceiling materials.”

